

SAGINAW CONTROL & ENGINEERING SCE-8C12ELJSS

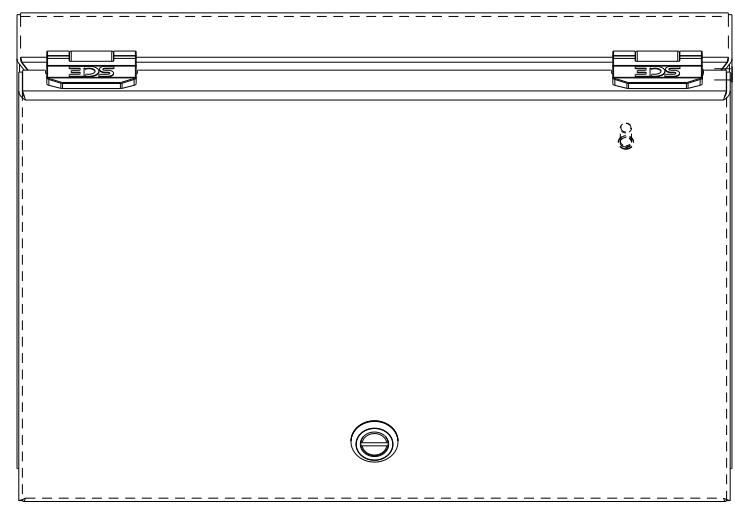

TOP VIEW

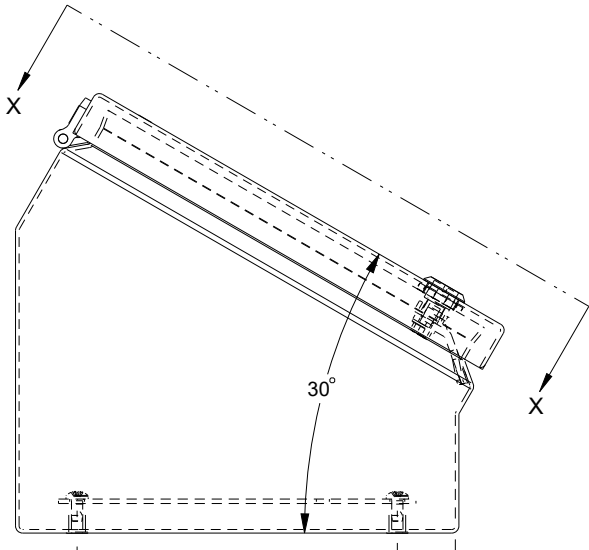

LEFT SIDE VIEW

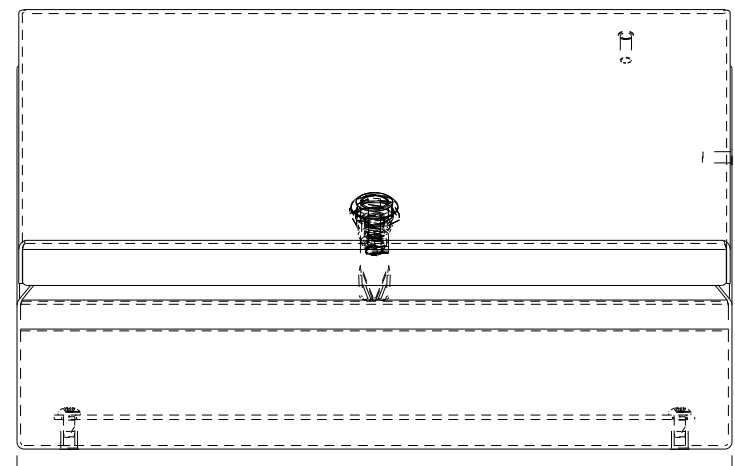

FRONT VIEW

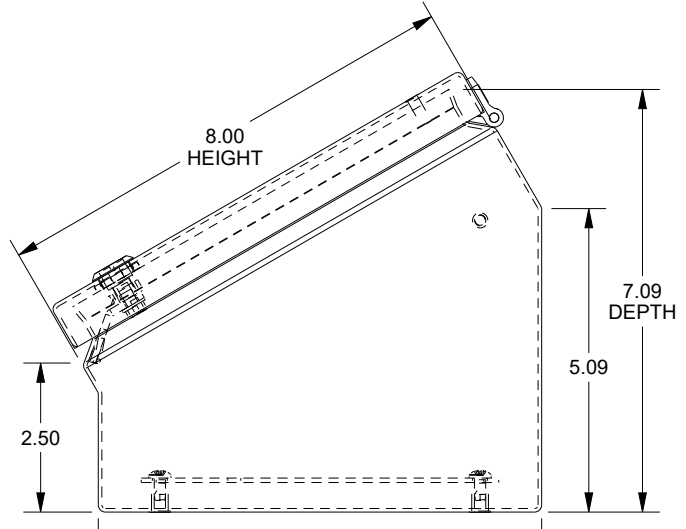

RIGHT SIDE VIEW

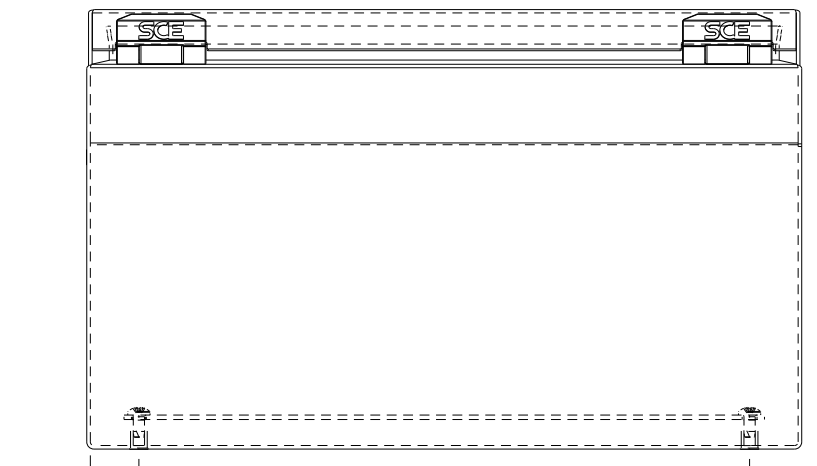

REAR VIEW

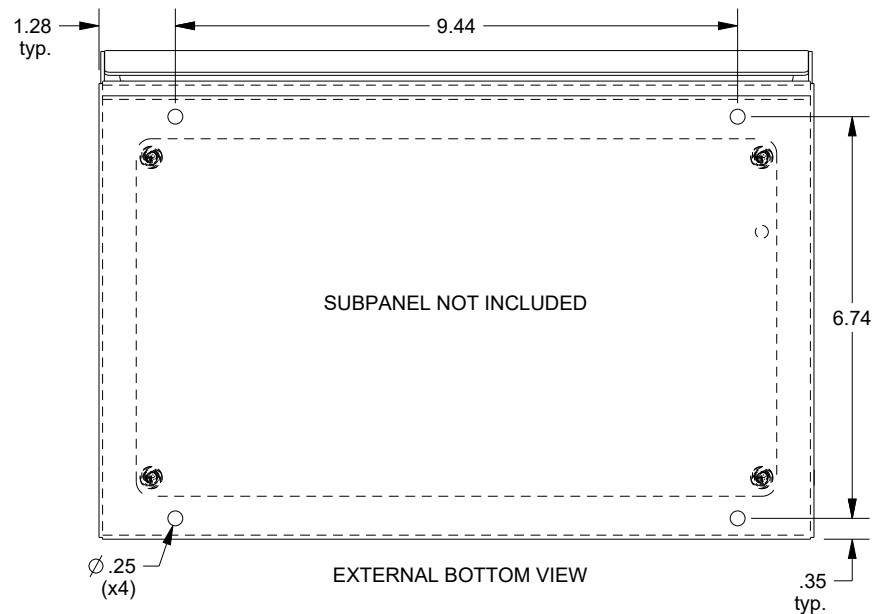

EXTERNAL BOTTOM VIEW

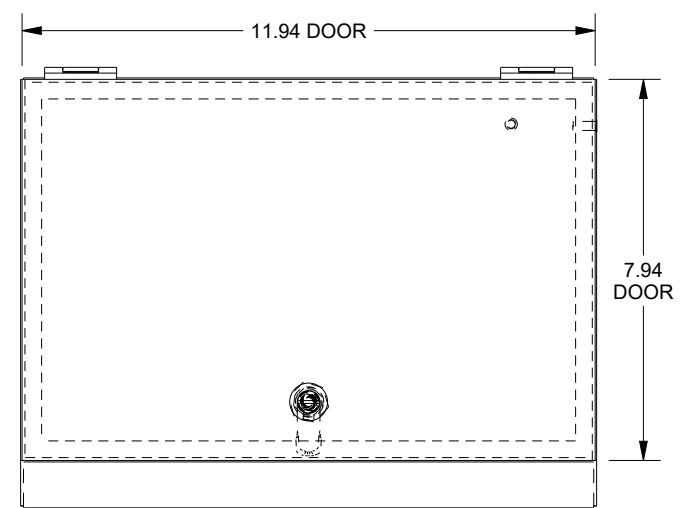

SECTION X-X
SCALE 0.250