

SAGINAW CONTROL & ENGINEERING

SCE-MOD84X7824

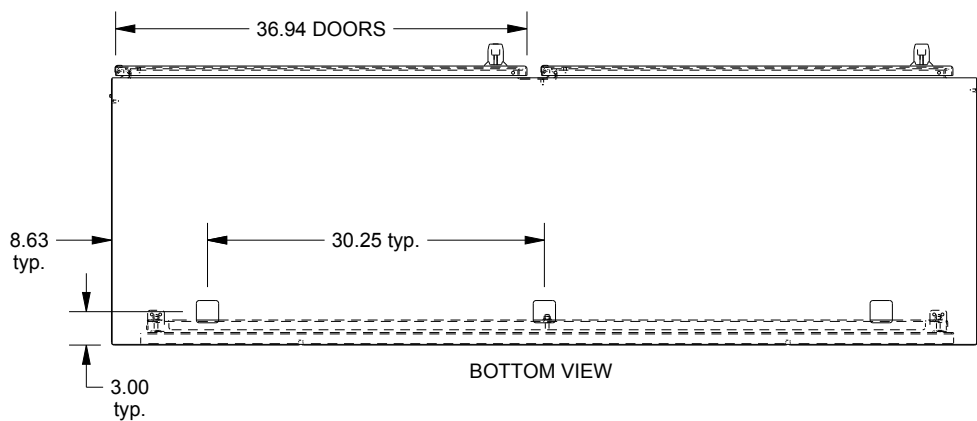
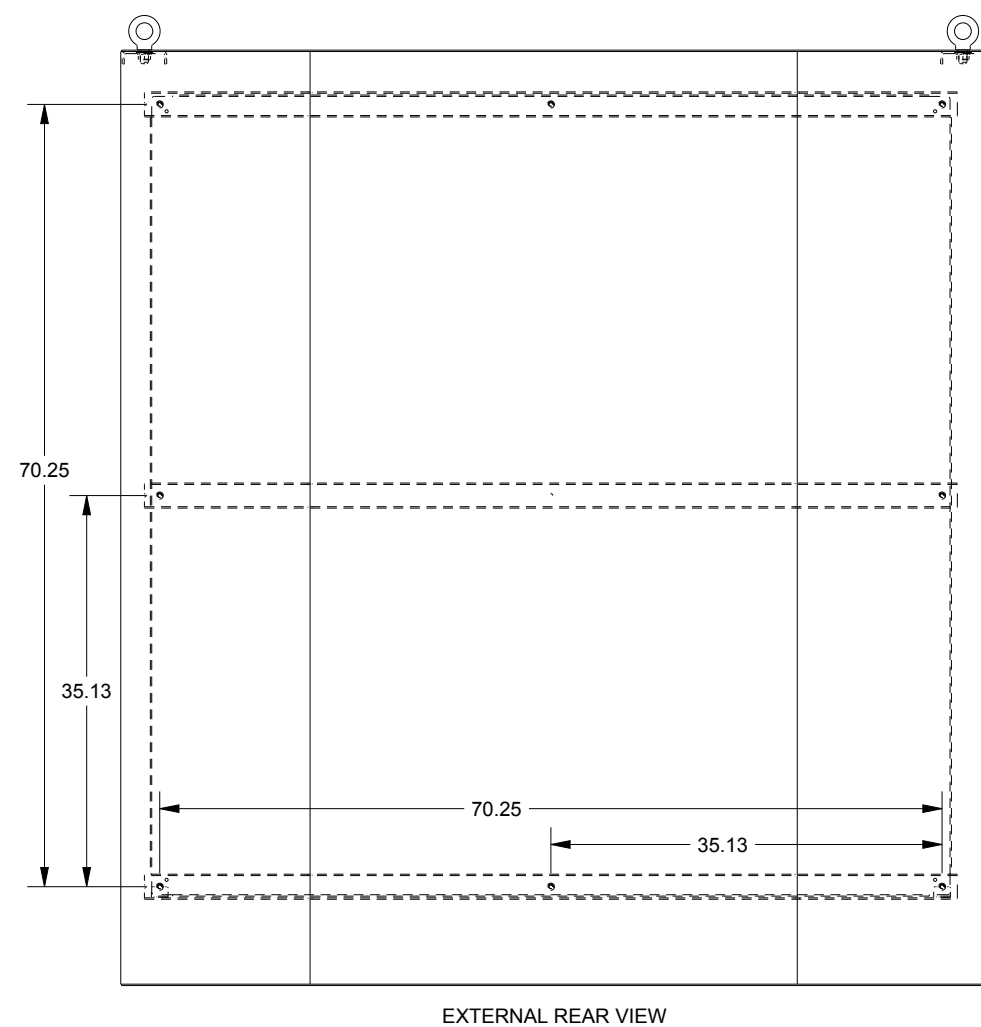
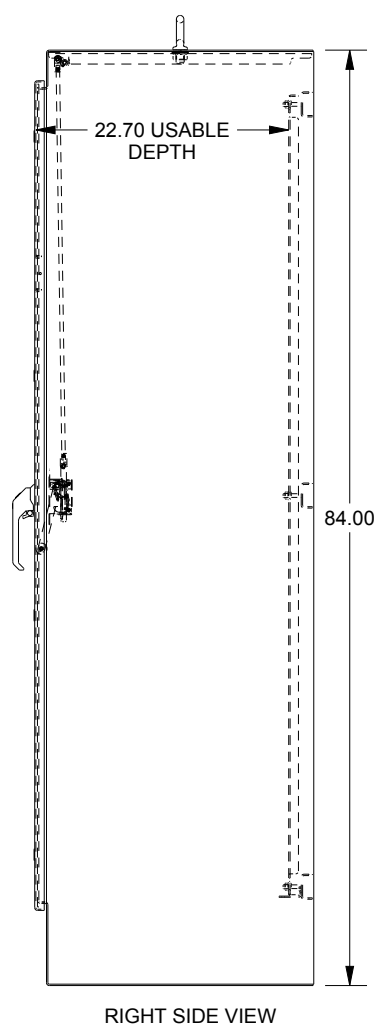
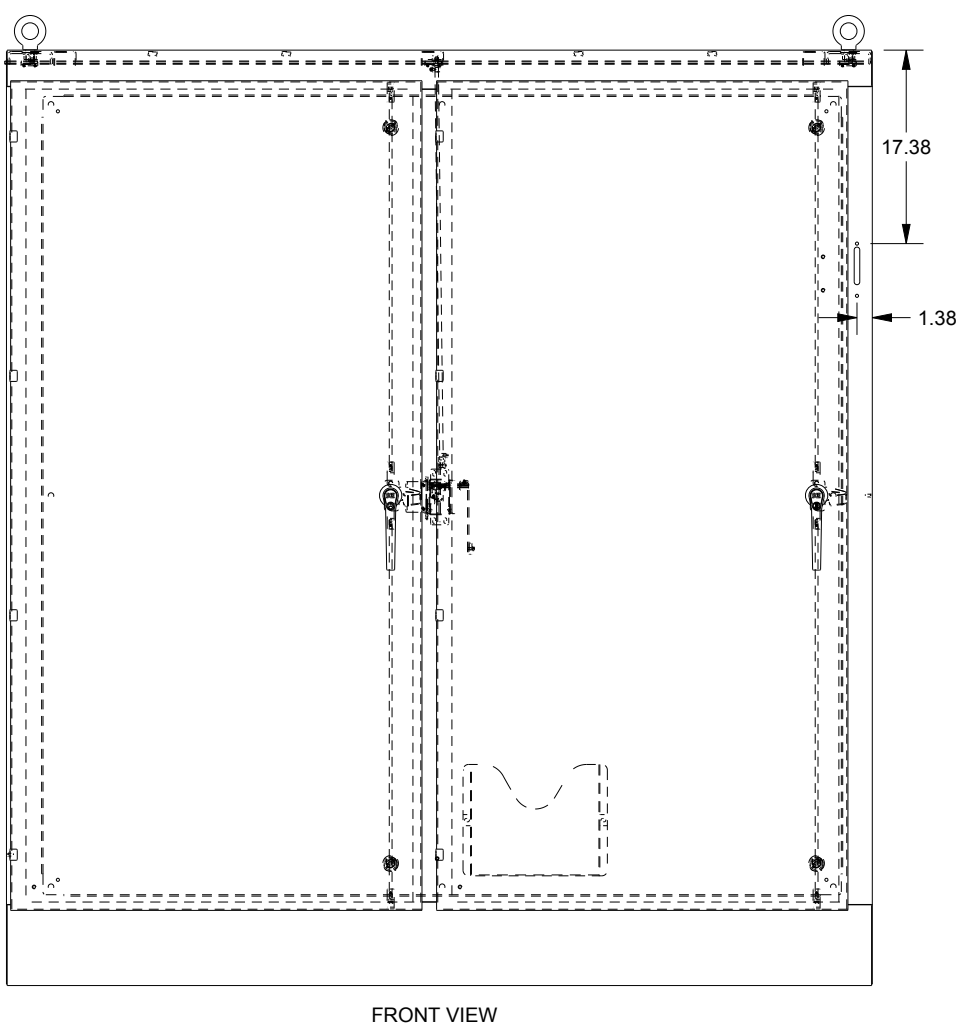
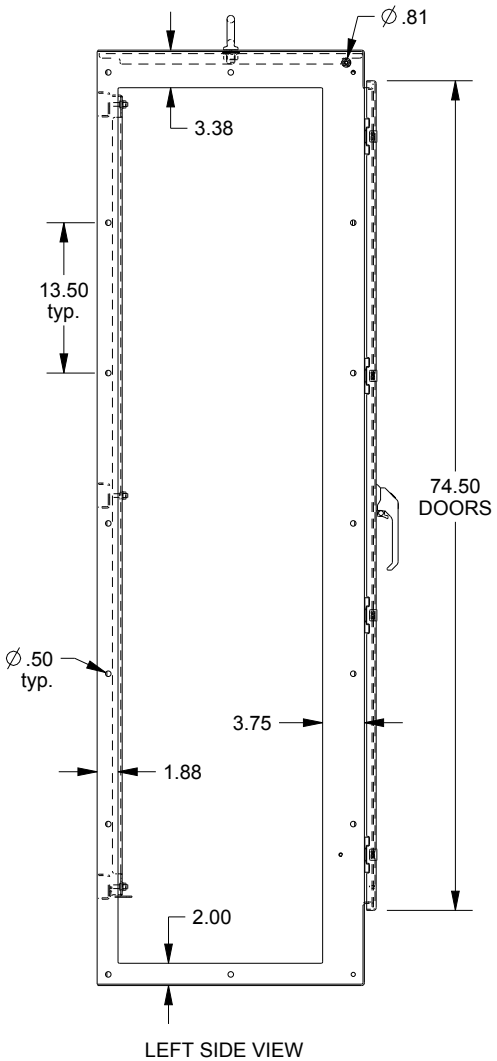
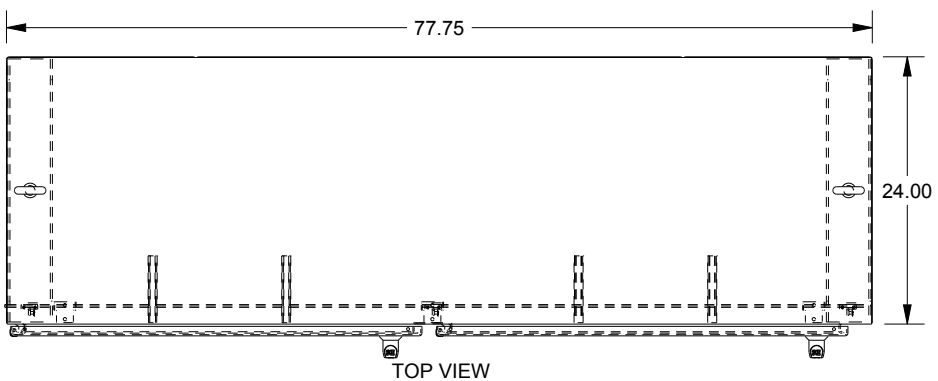

WASH SYSTEM 2" SQUARE DRAIN HOLES IN THE BOTTOM WITH UL APPROVED HOLE SEALS PROVIDED