

SAGINAW CONTROL & ENGINEERING

SCE-90XM6EW24G SHT.1 OF 2

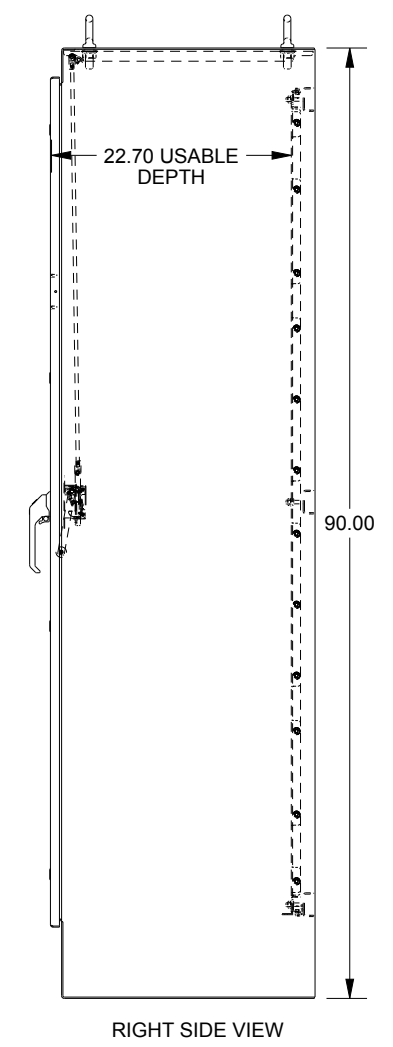
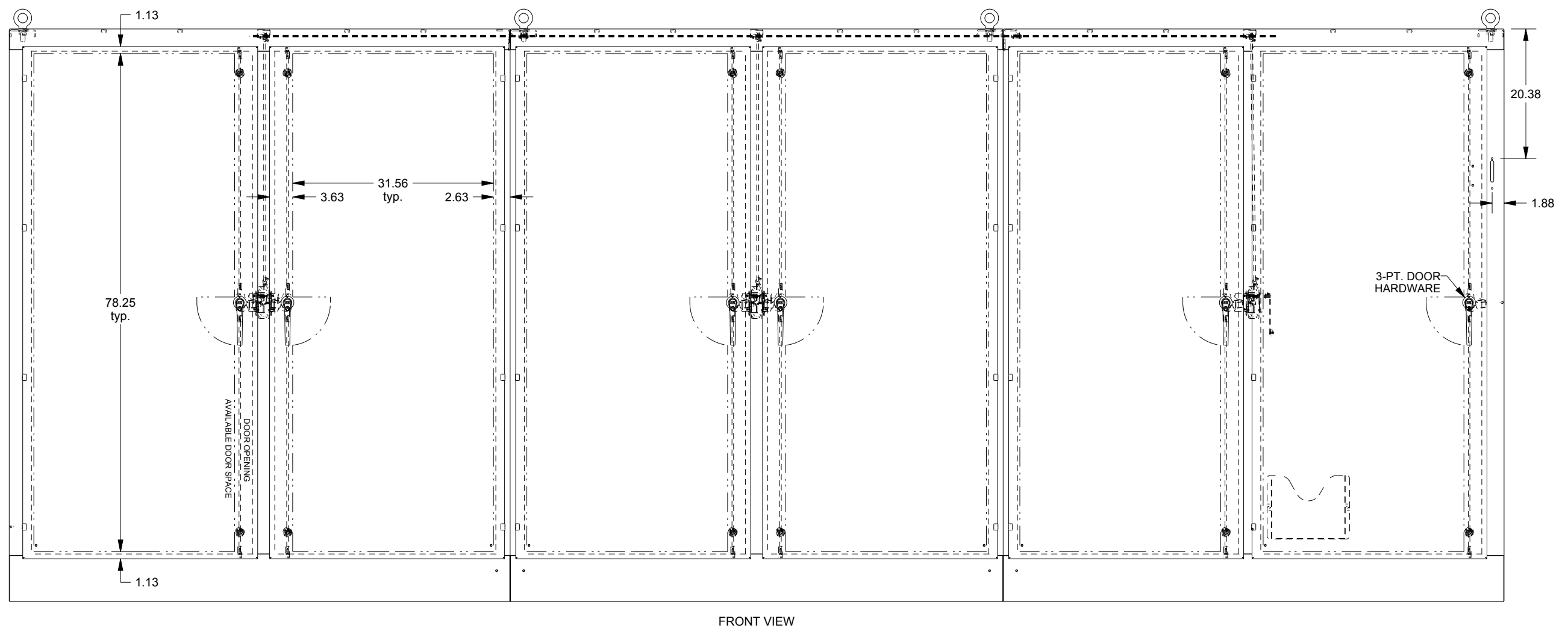
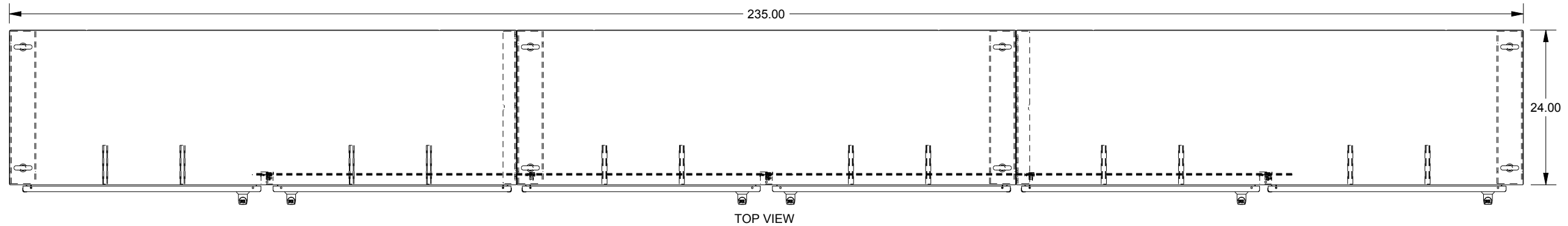

SAGINAW CONTROL & ENGINEERING

SCE-90XM6EW24G SHT.2 OF 2

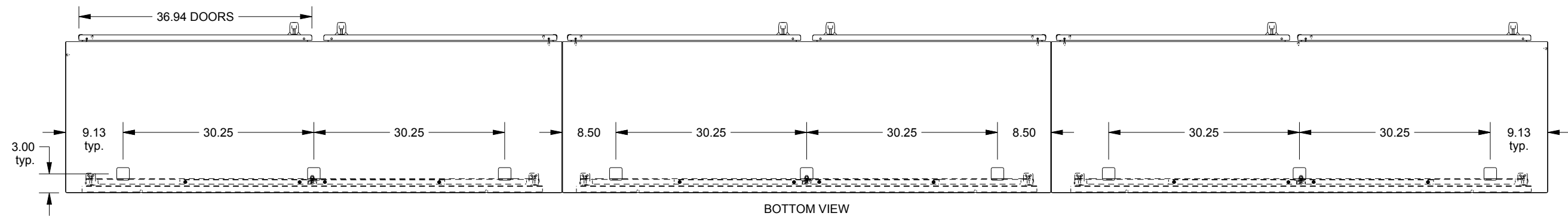
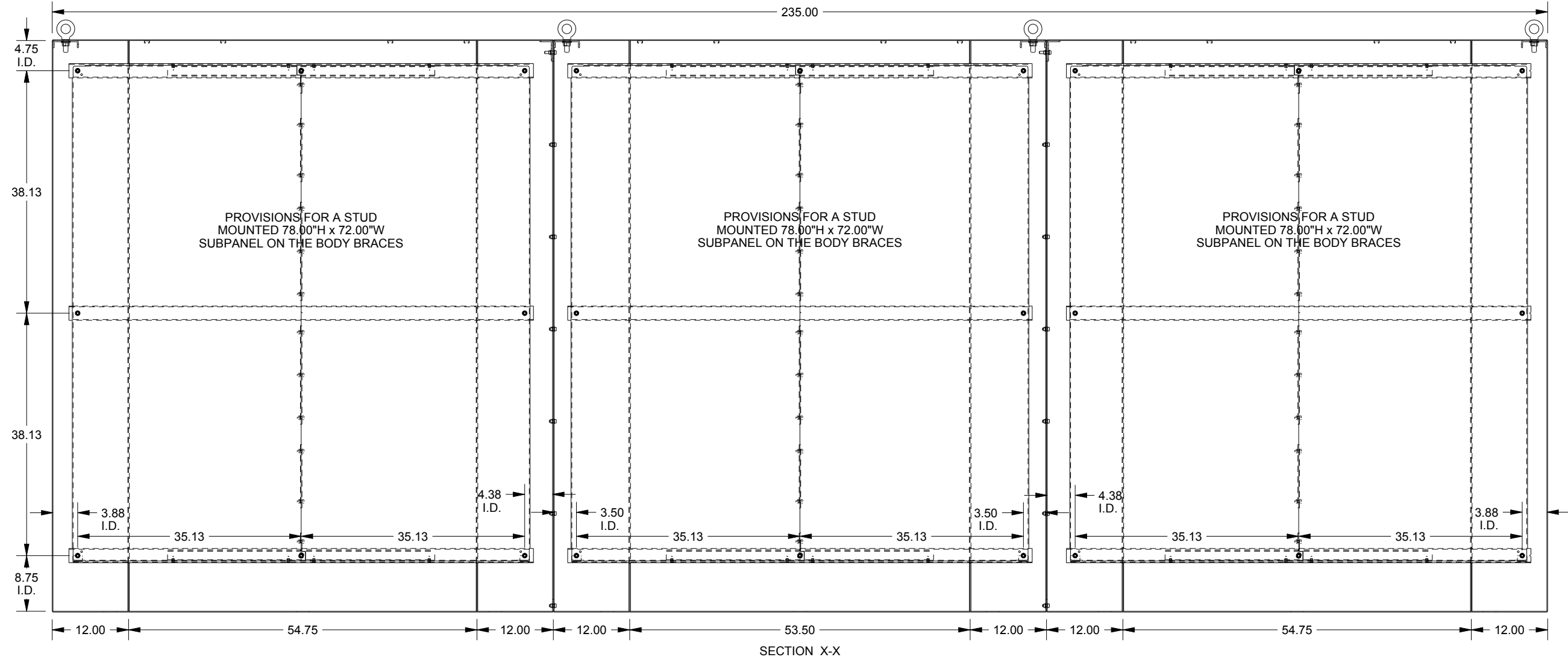
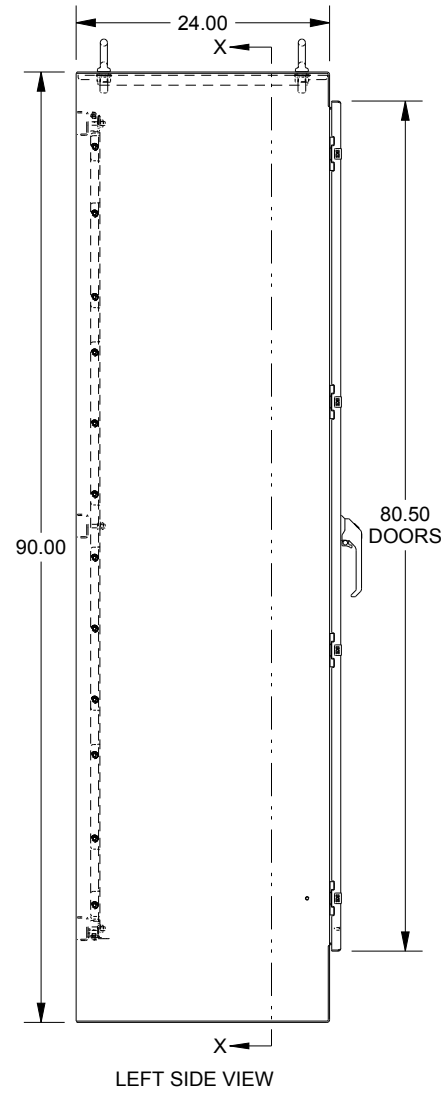

WASH SYSTEM 2" SQUARE DRAIN HOLES IN THE BOTTOM WITH UL APPROVED HOLE SEALS PROVIDED