

SAGINAW CONTROL & ENGINEERING SCE-90XM3EW24G Sheet 1 of 2

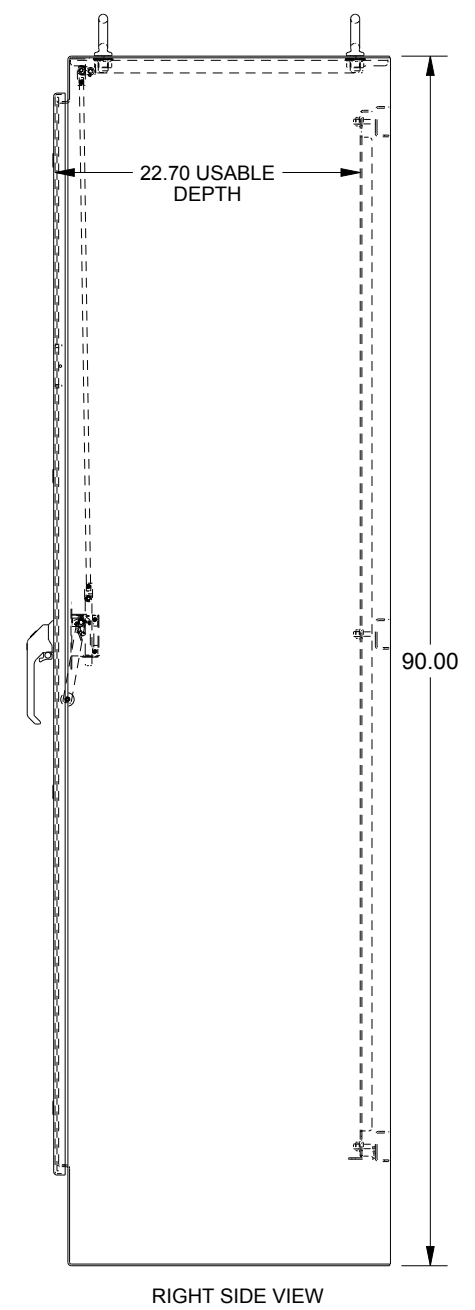

SAGINAW CONTROL & ENGINEERING

SCE-90XM3EW24G Sheet 2 of 2

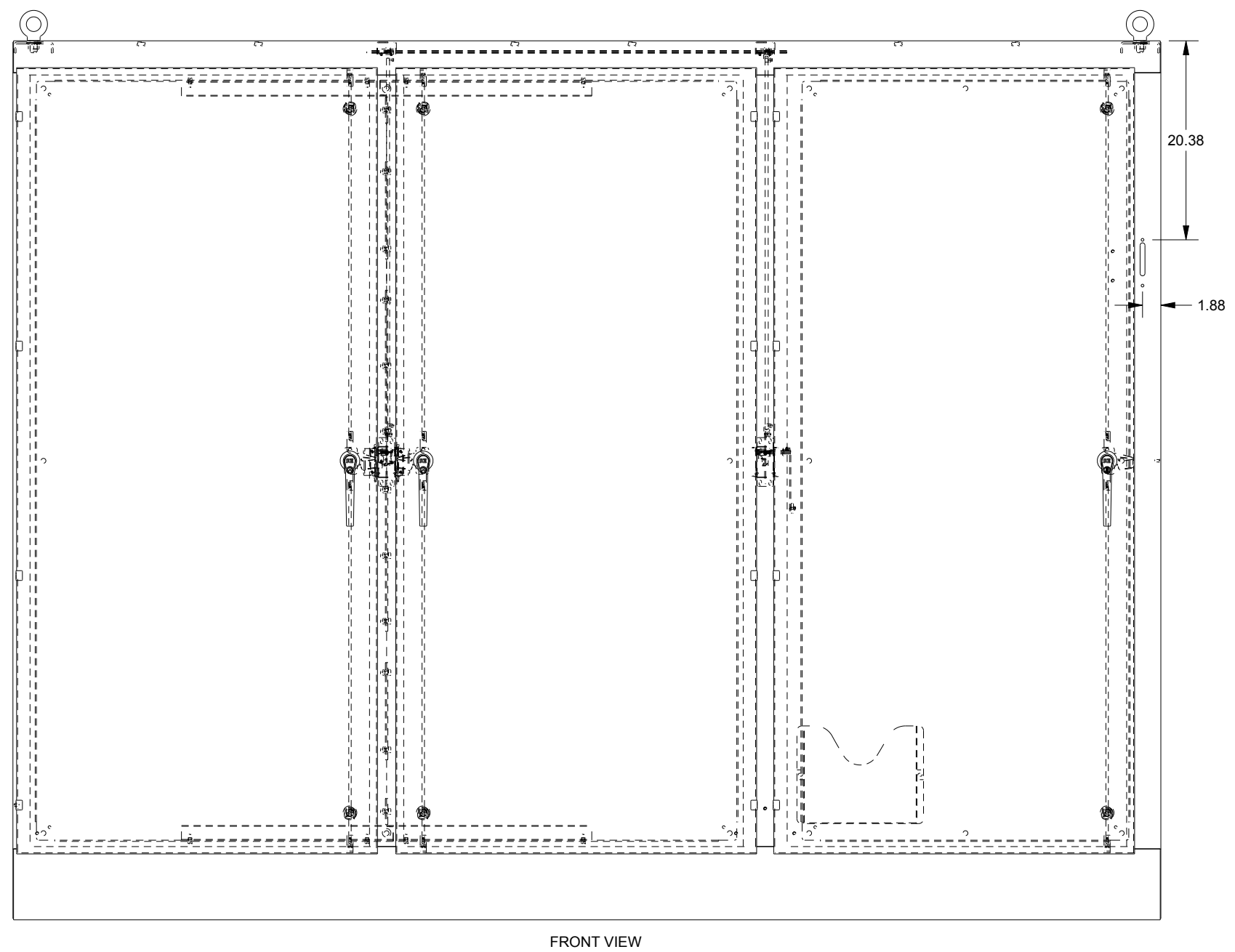
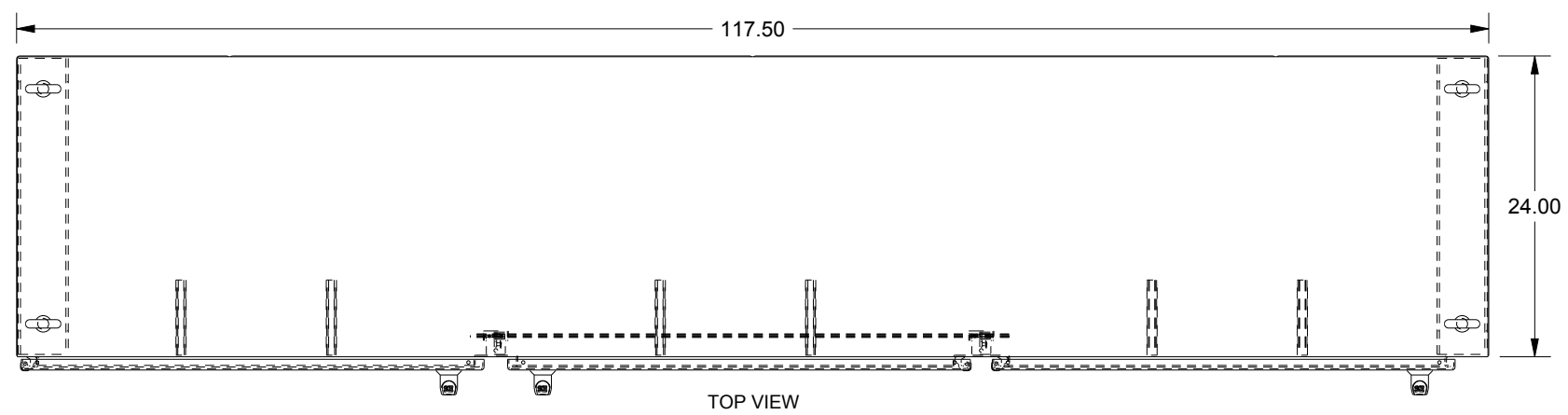
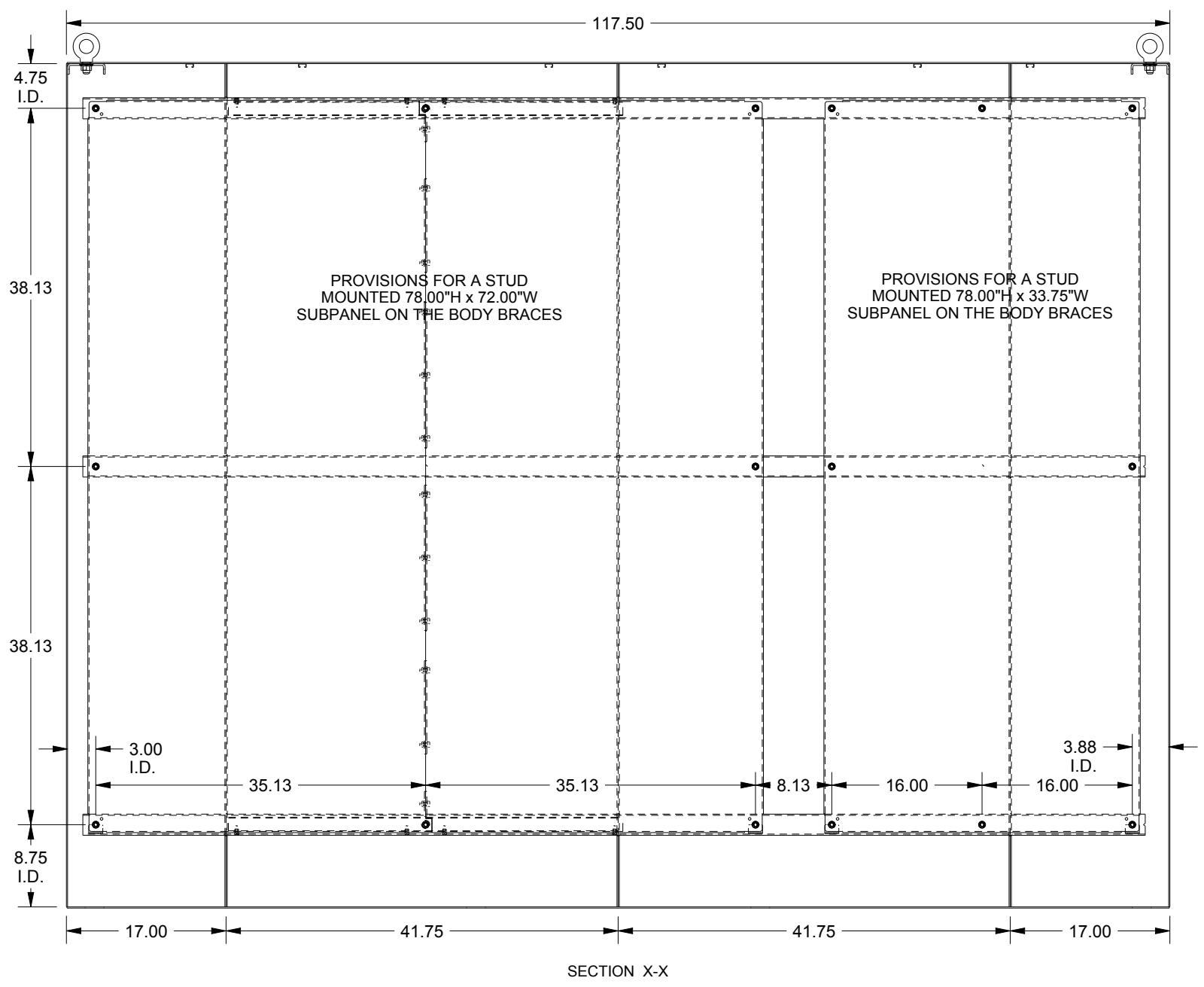
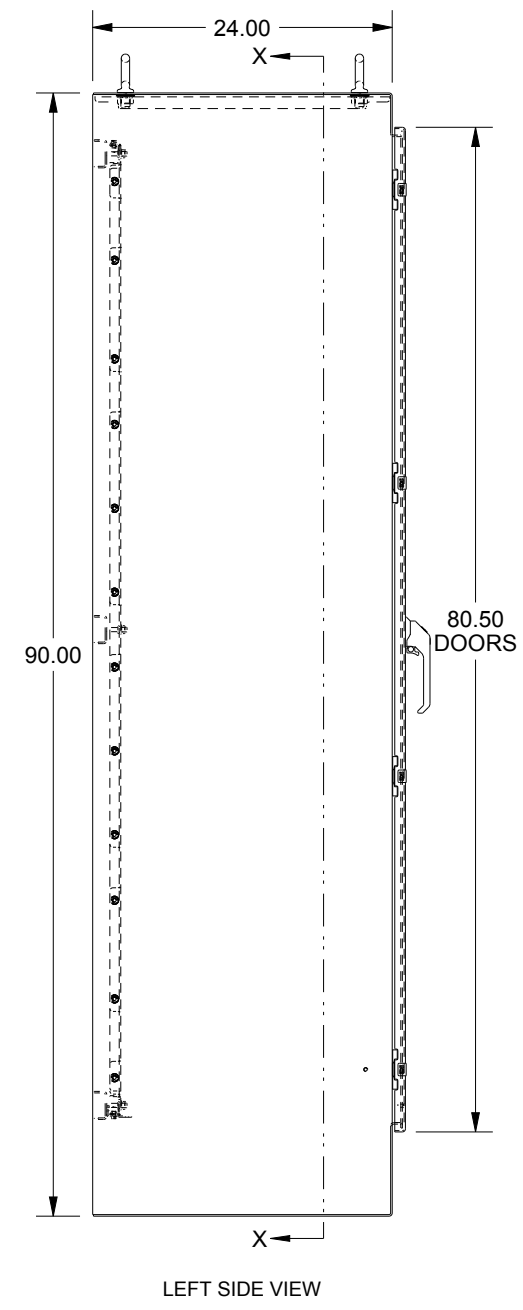

WASH SYSTEM 2" SQUARE DRAIN HOLES IN THE BOTTOM WITH UL APPROVED HOLE SEALS PROVIDED

