

SAGINAW CONTROL & ENGINEERING

SCE-90XM3EW24 Sheet 1 of 2

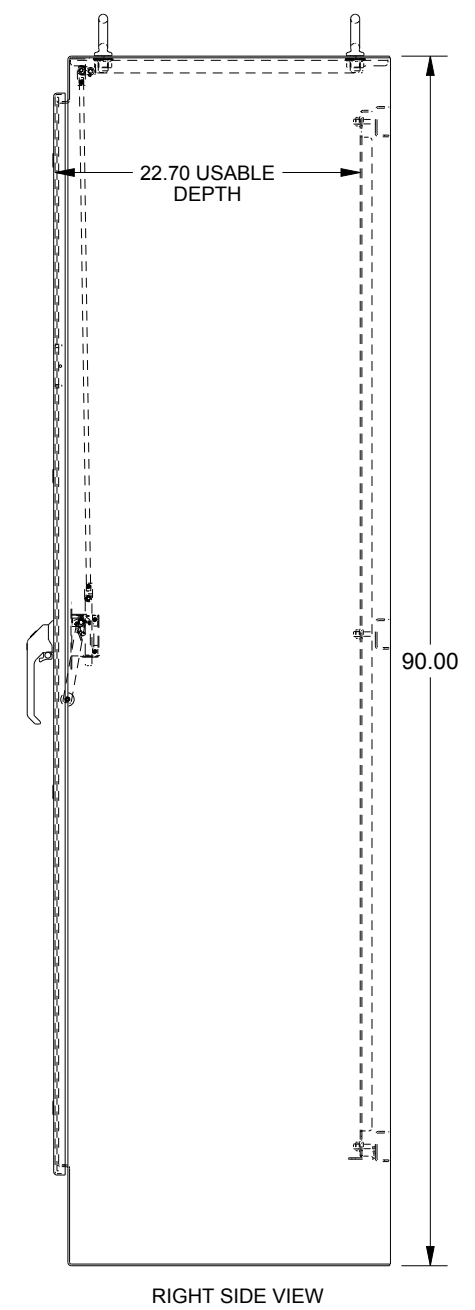
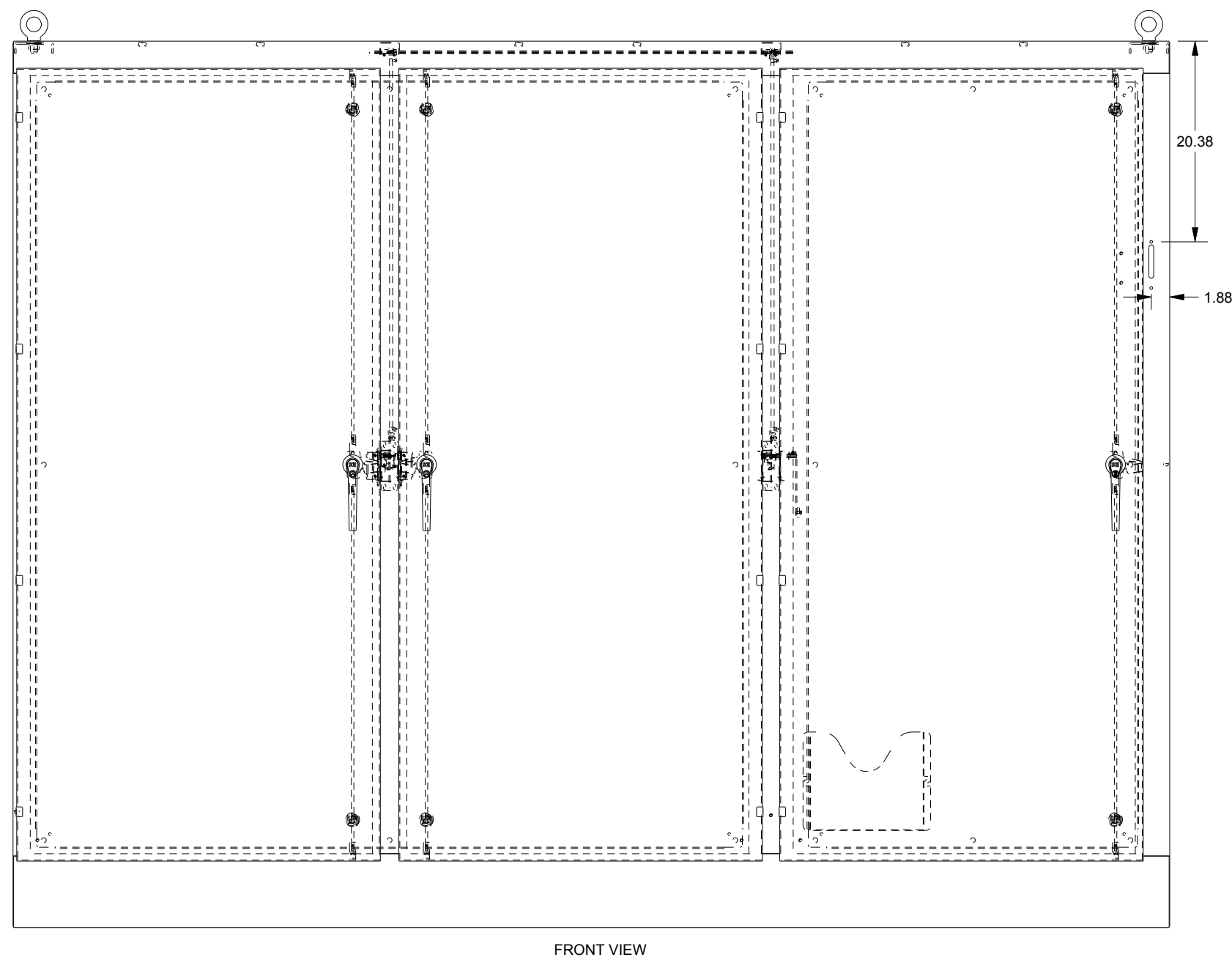
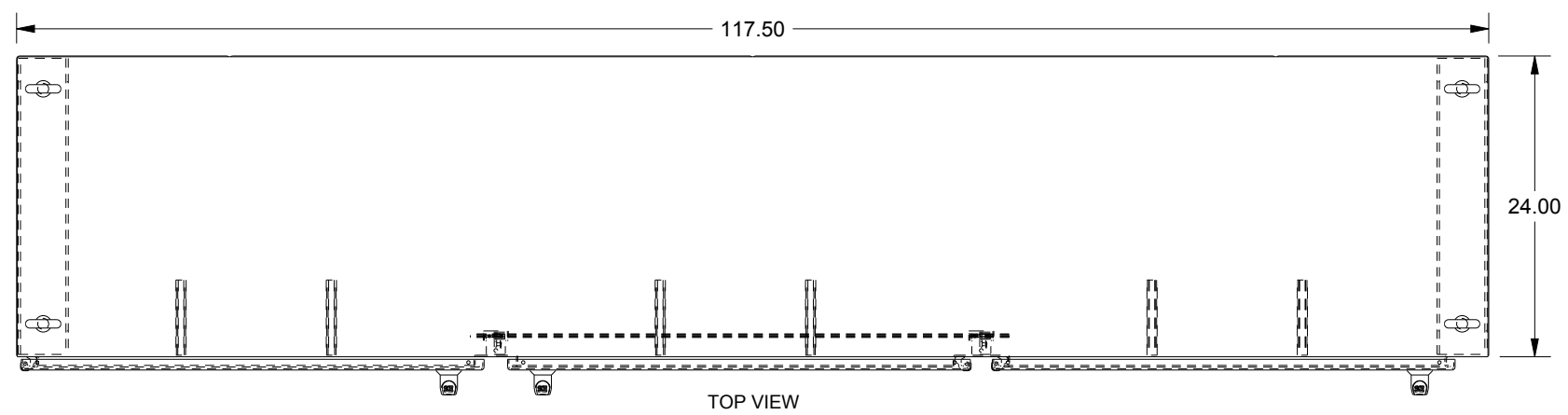

SAGINAW CONTROL & ENGINEERING

SCE-90XM3EW24 Sheet 2 of 2

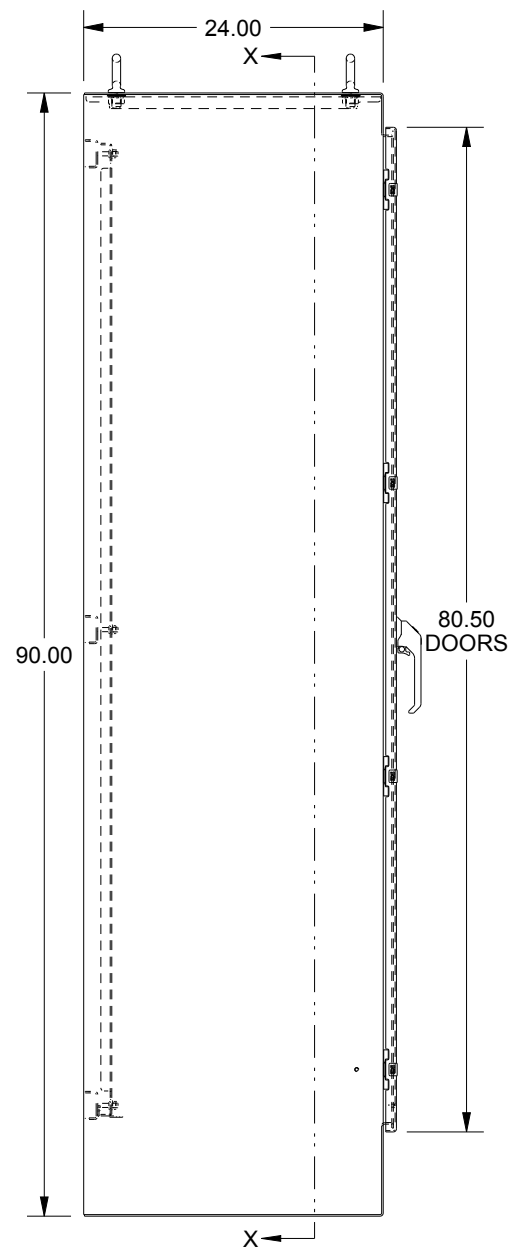

LEFT SIDE VIEW

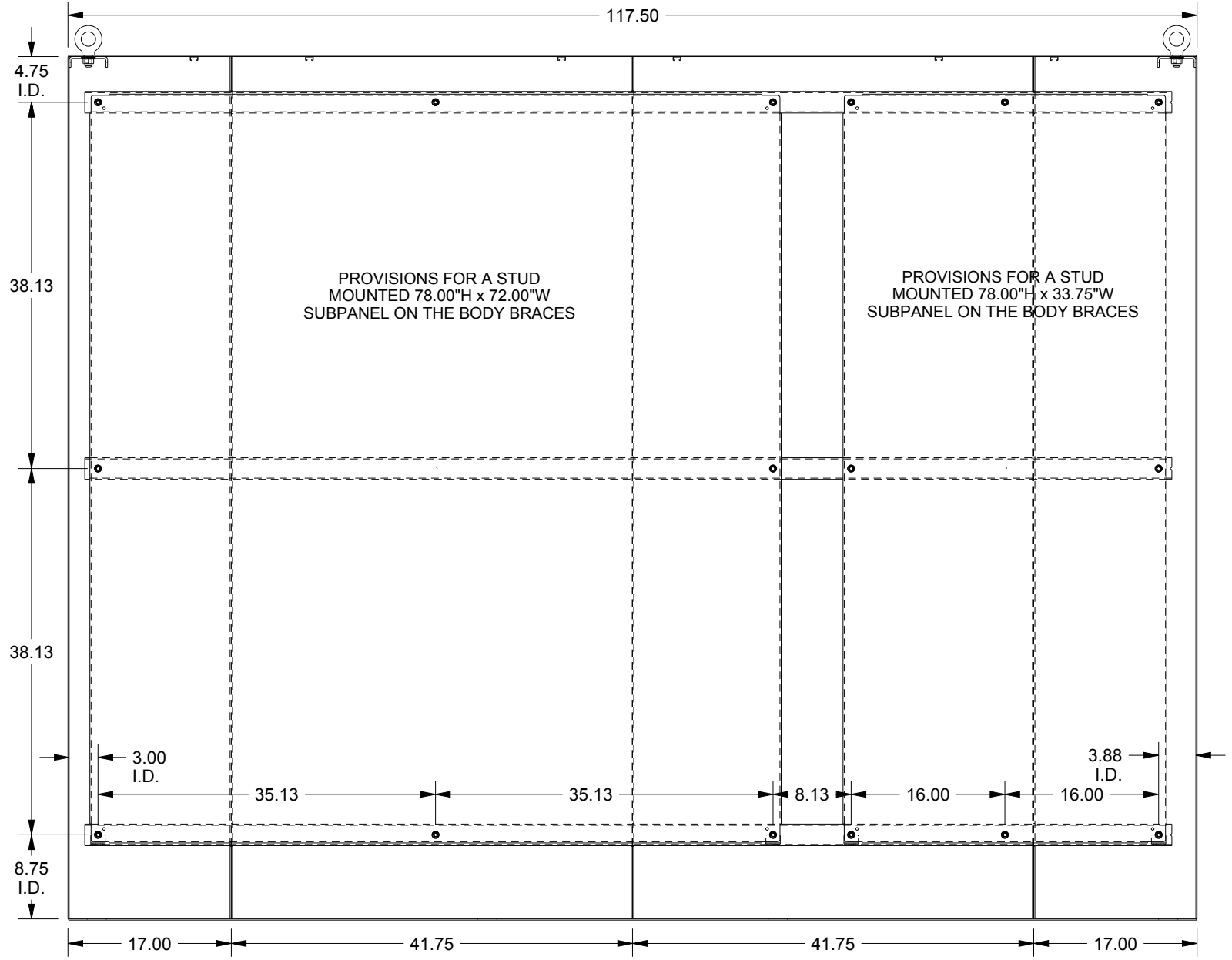

SECTION X-X

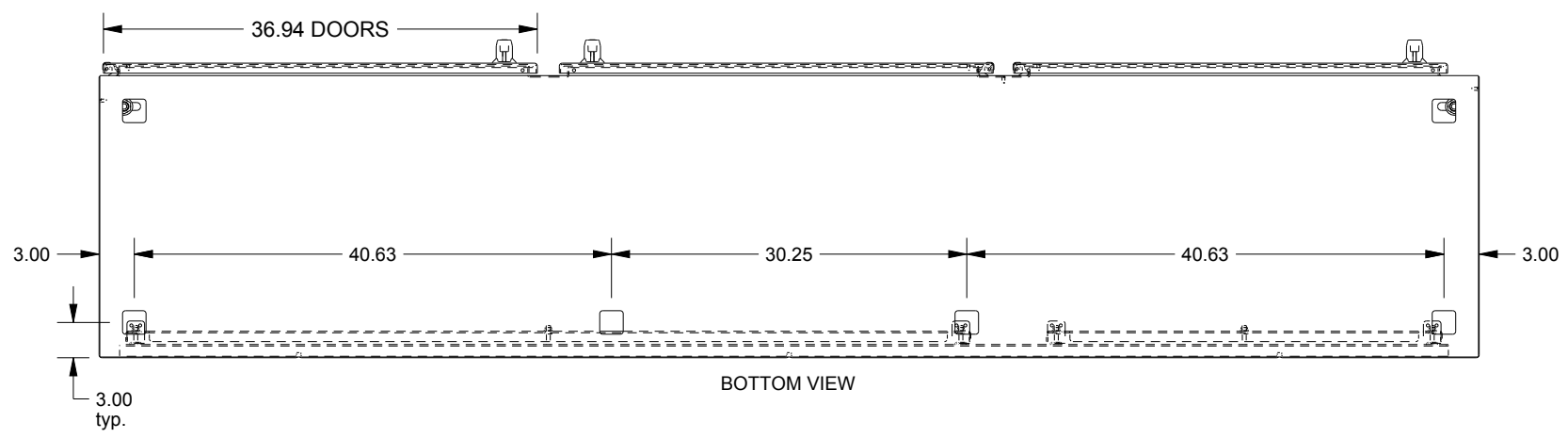

BOTTOM VIEW

WASH SYSTEM 2" SQUARE DRAIN HOLES IN THE BOTTOM WITH UL APPROVED HOLE SEALS PROVIDED