

SAGINAW CONTROL & ENGINEERING SCE-72XM3EW18G Sheet 1 of 2

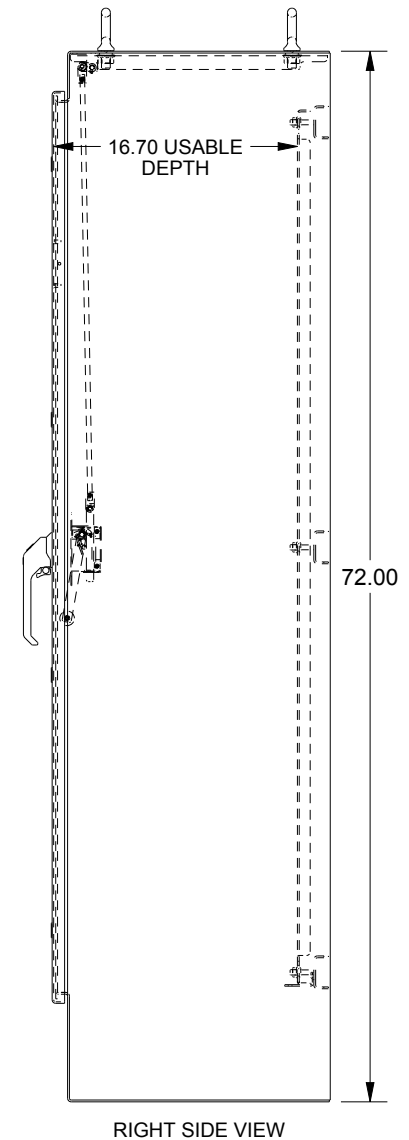

SAGINAW CONTROL & ENGINEERING

SCE-72XM3EW18G Sheet 2 of 2

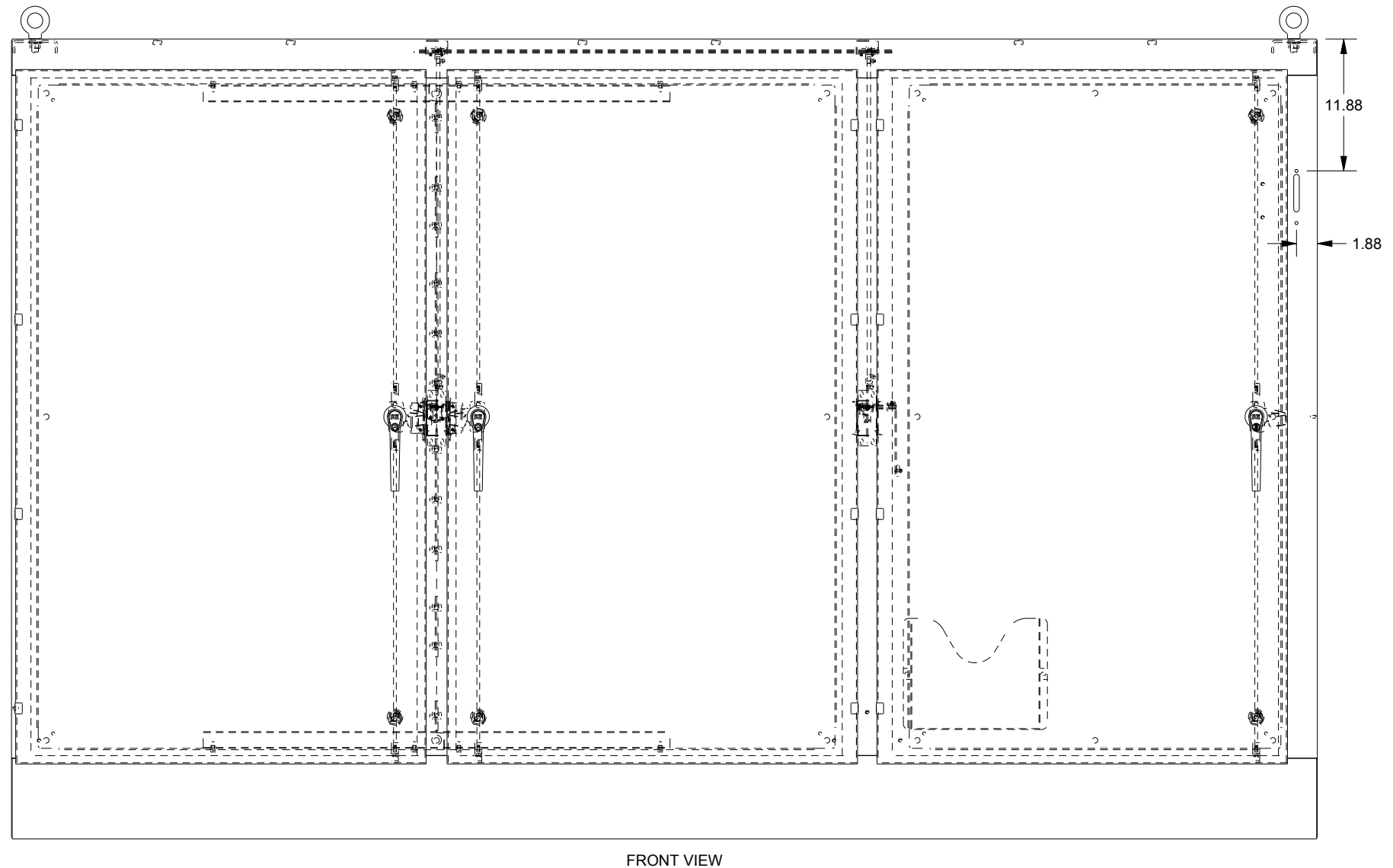
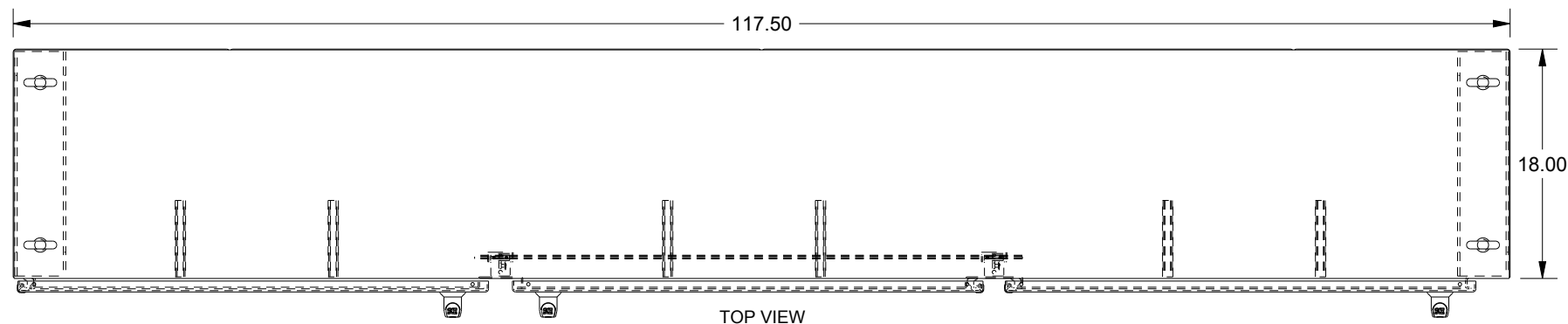
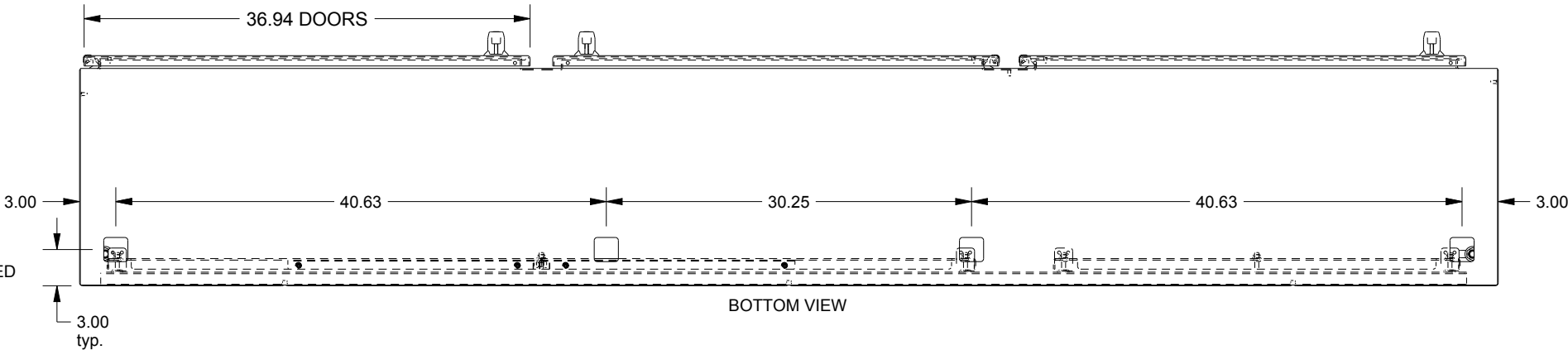
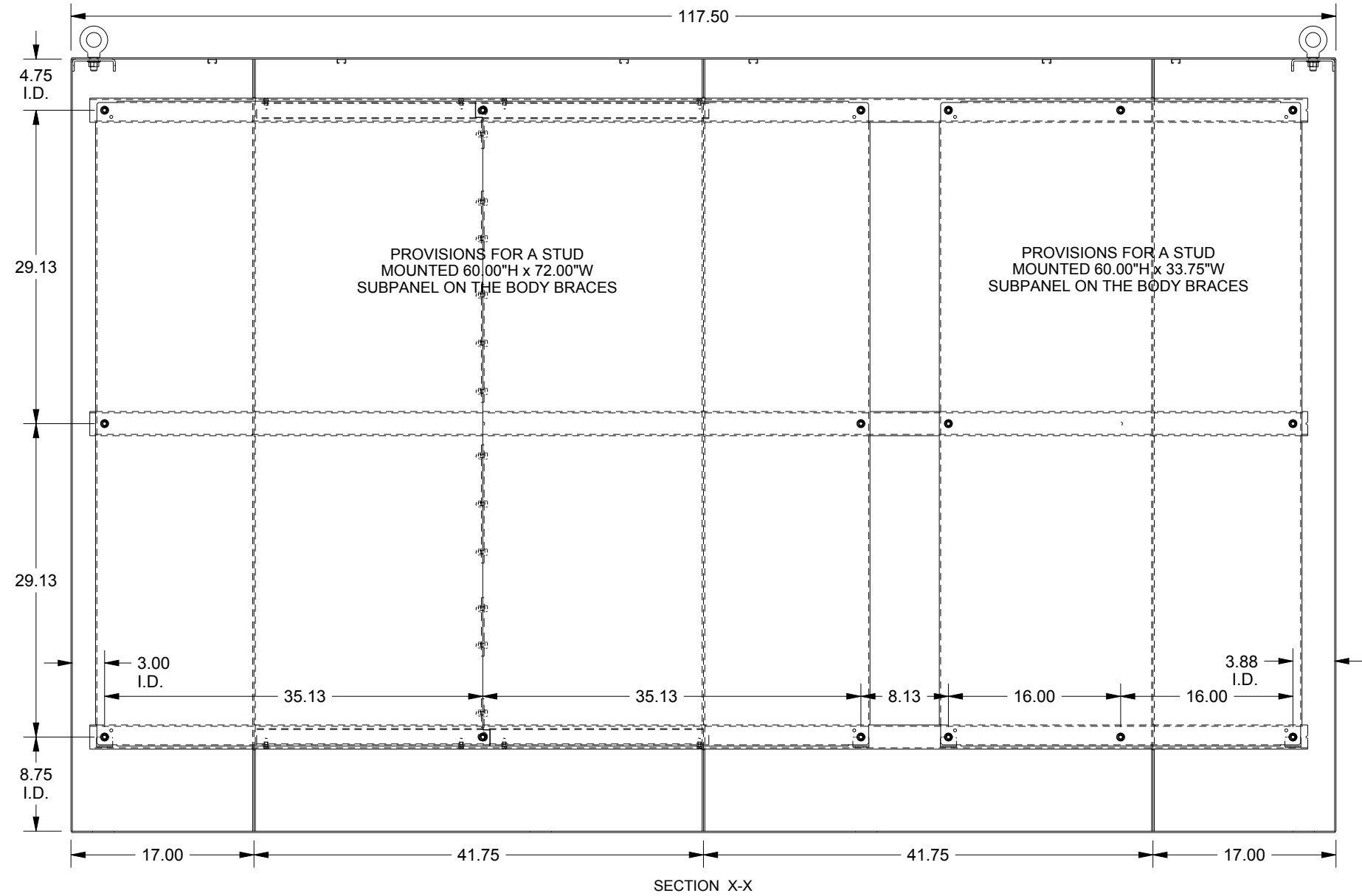
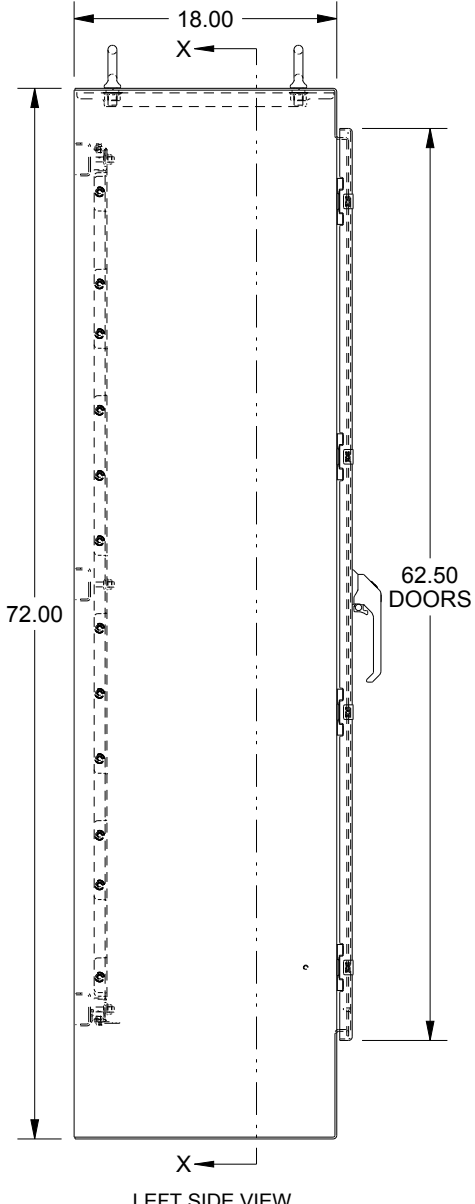

WASH SYSTEM 2" SQUARE DRAIN HOLES IN THE BOTTOM WITH UL APPROVED HOLE SEALS PROVIDED