

SAGINAW CONTROL & ENGINEERING

SCE-72XM3EW18 Sheet 1 of 2

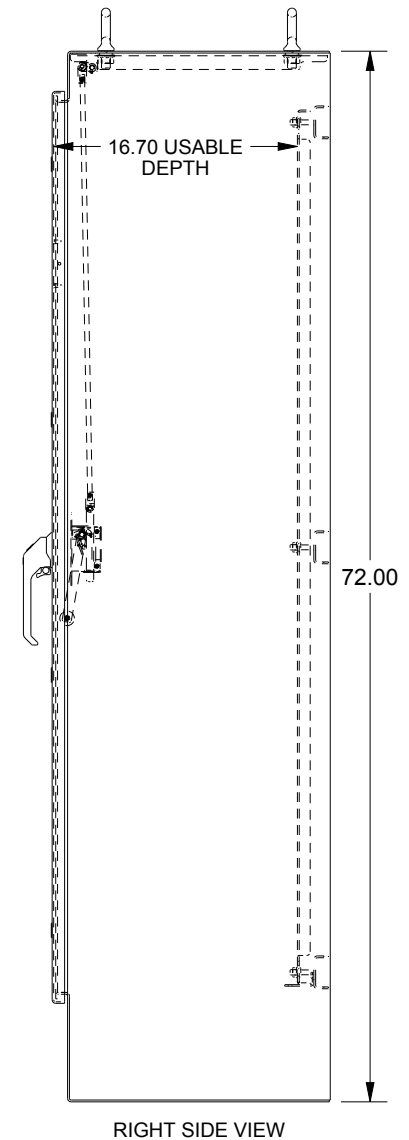
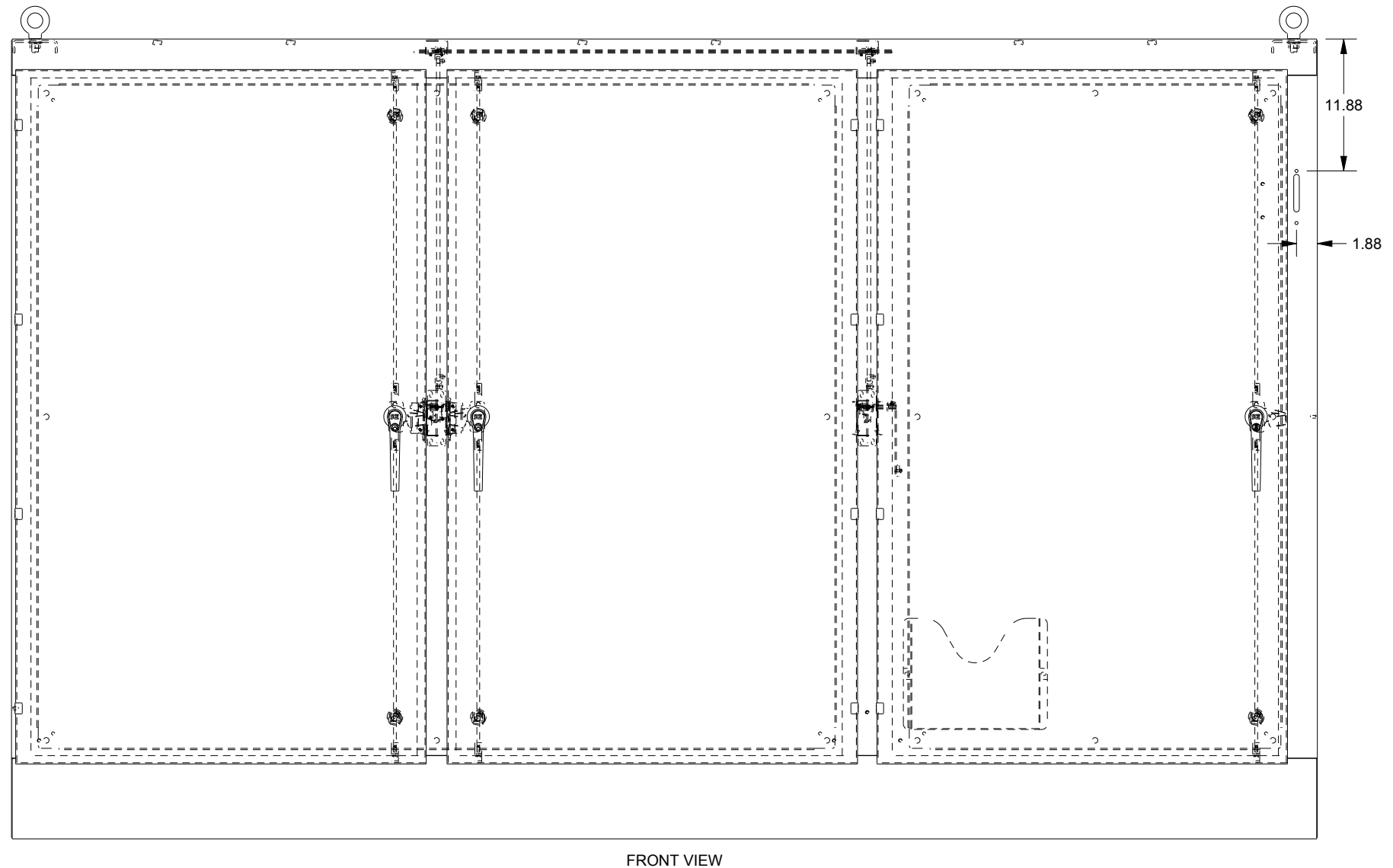
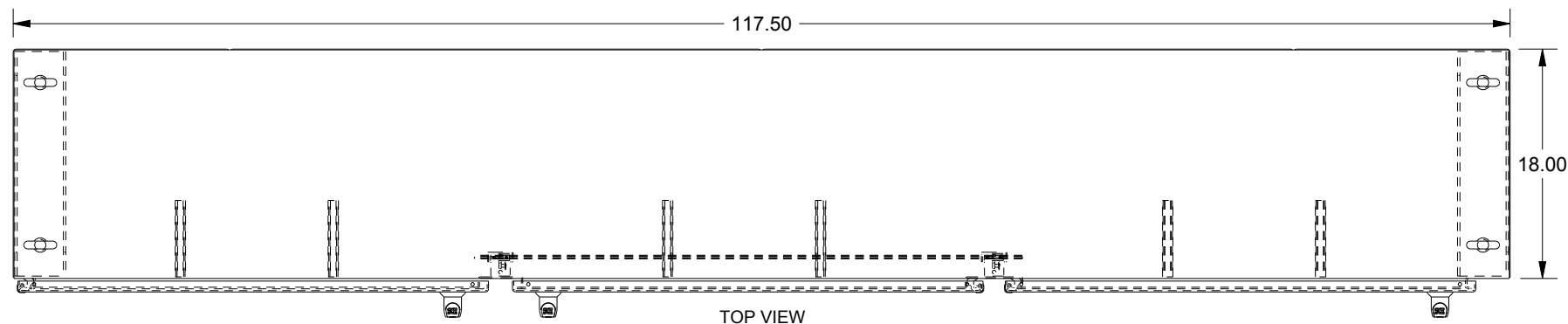

SAGINAW CONTROL & ENGINEERING

SCE-72XM3EW18 Sheet 2 of 2

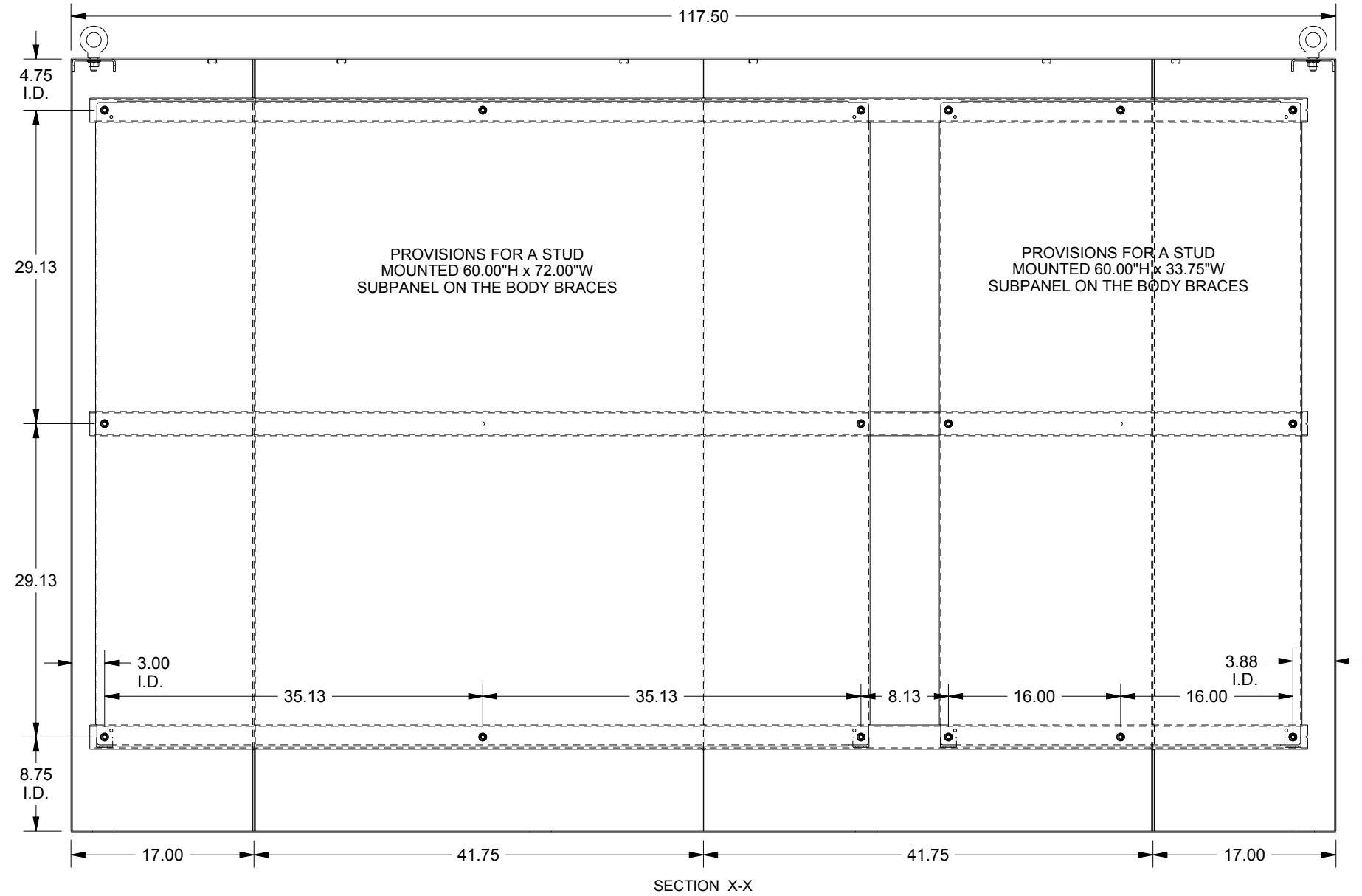
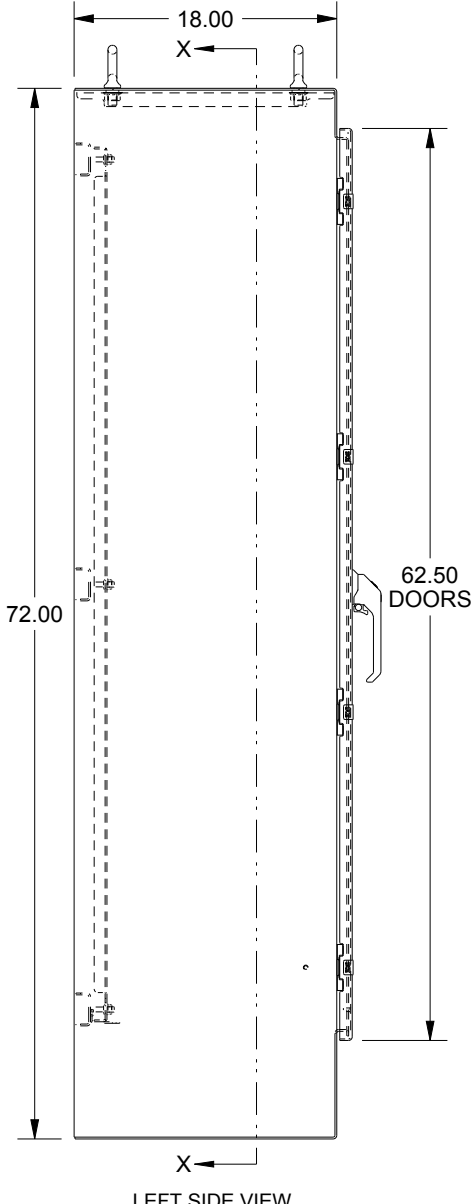

WASH SYSTEM 2" SQUARE DRAIN HOLES IN THE BOTTOM WITH UL APPROVED HOLE SEALS PROVIDED

