

SAGINAW CONTROL & ENGINEERING

SCE-72EL7224FSD

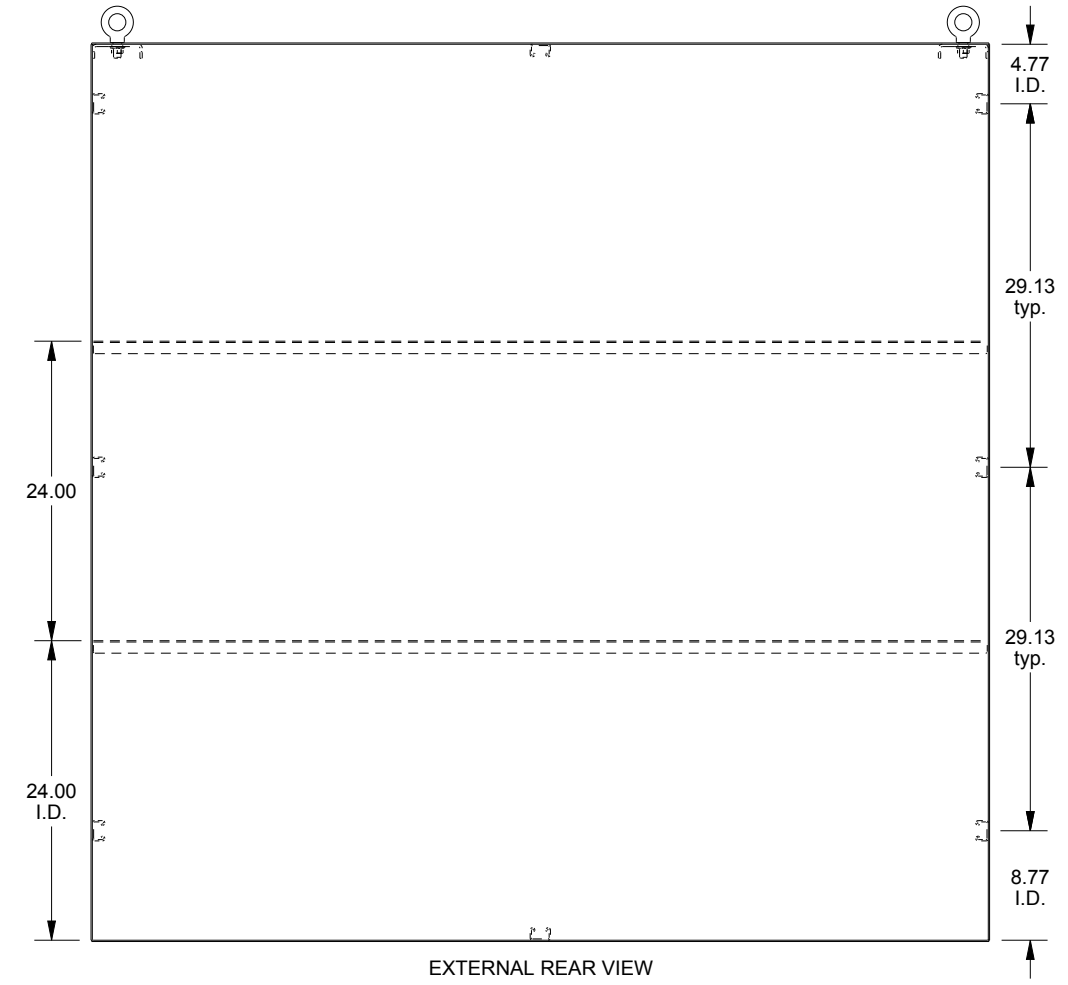

WASH SYSTEM 2" SQUARE DRAIN HOLES IN THE
BOTTOM WITH UL APPROVED HOLE SEALS PROVIDED

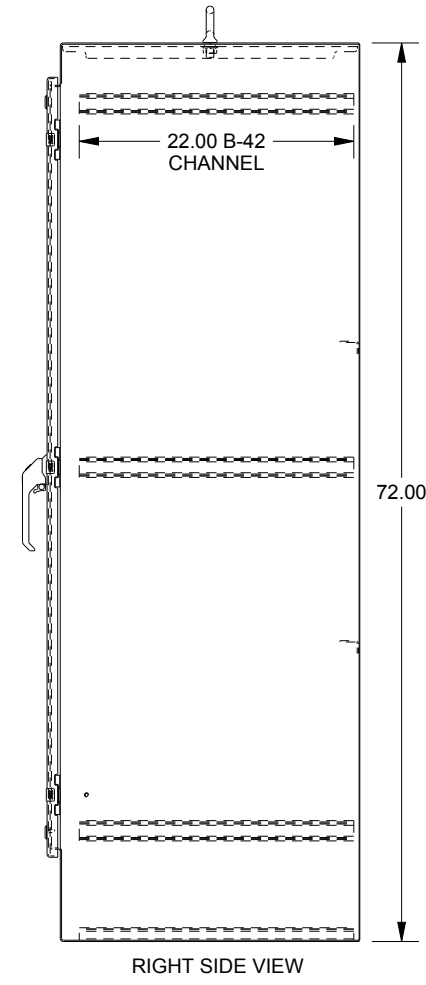
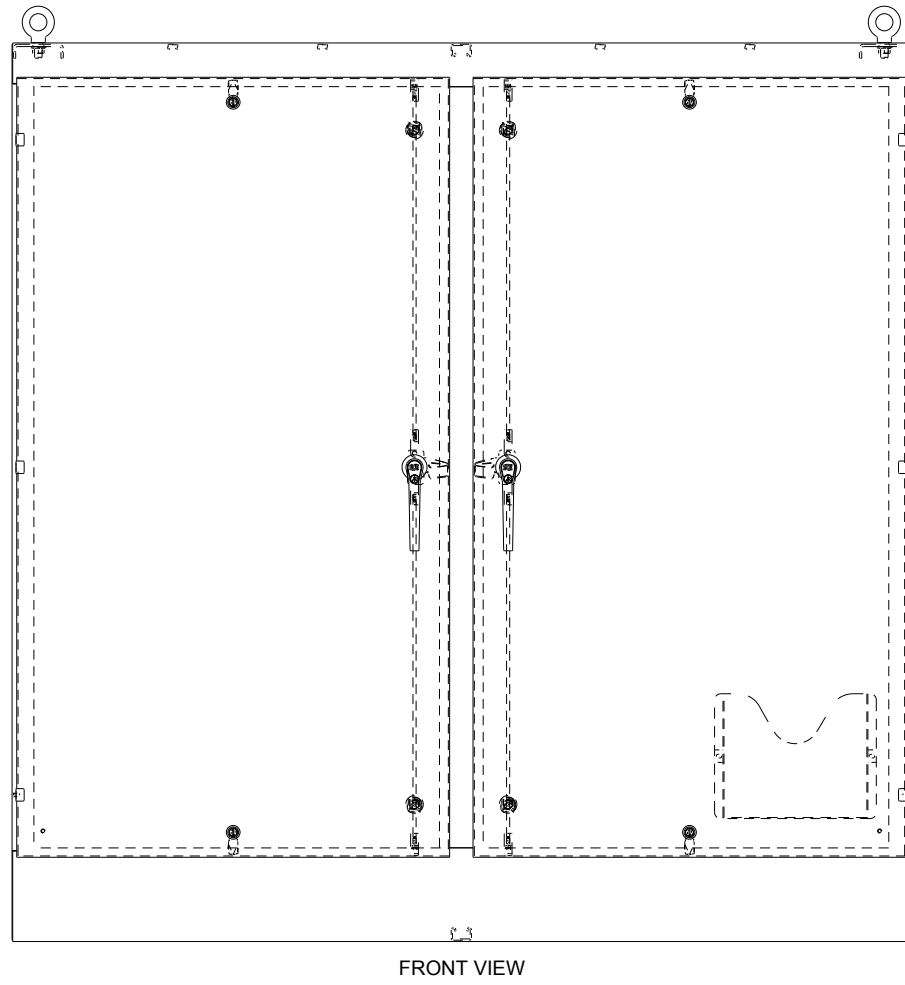
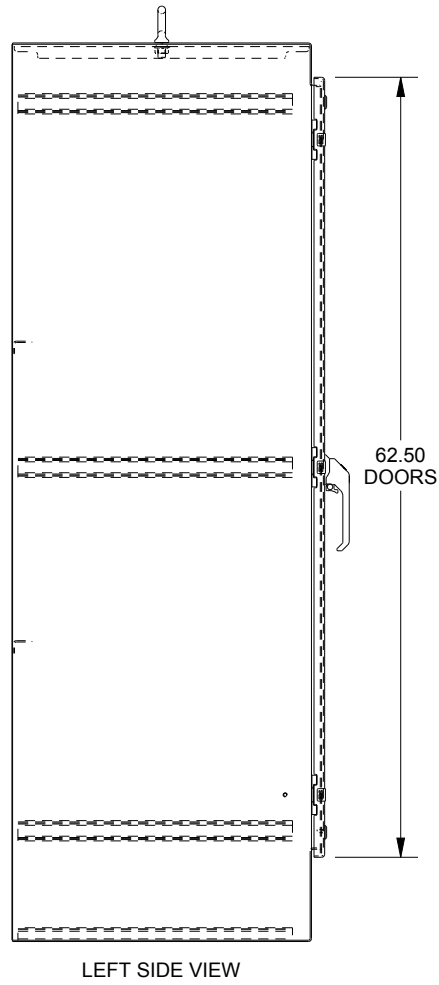
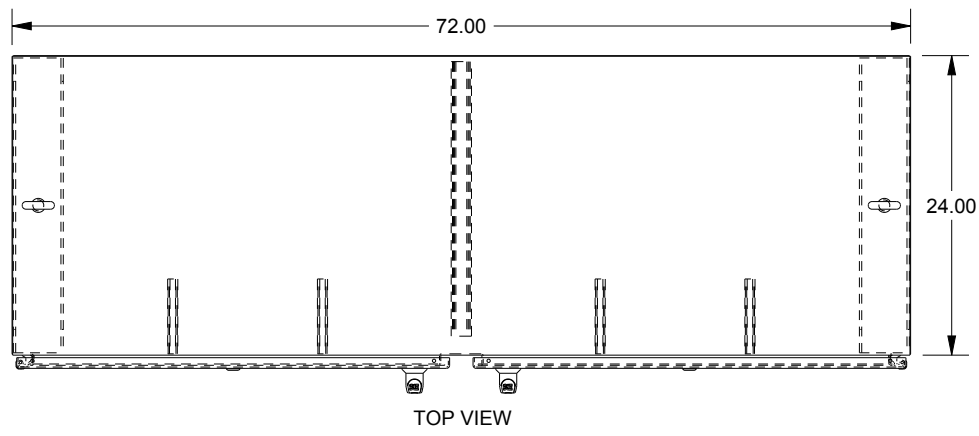