

SAGINAW CONTROL & ENGINEERING

SCE-72EL7218FSD

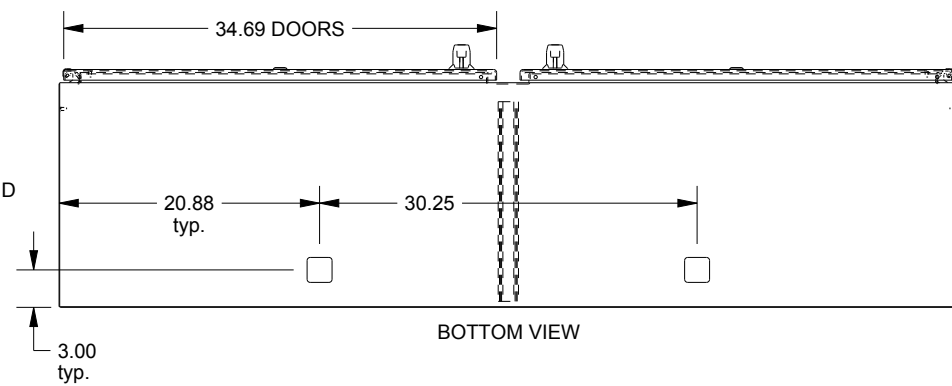
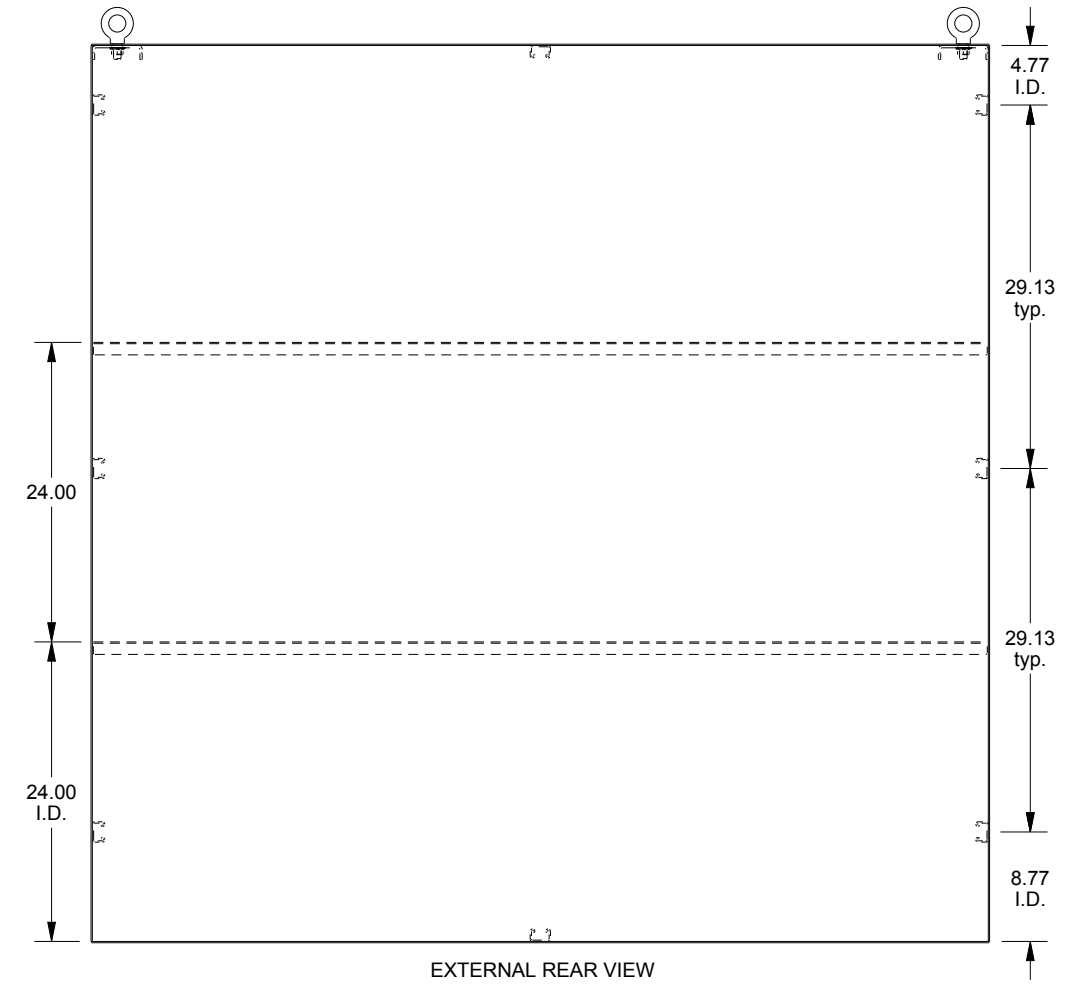
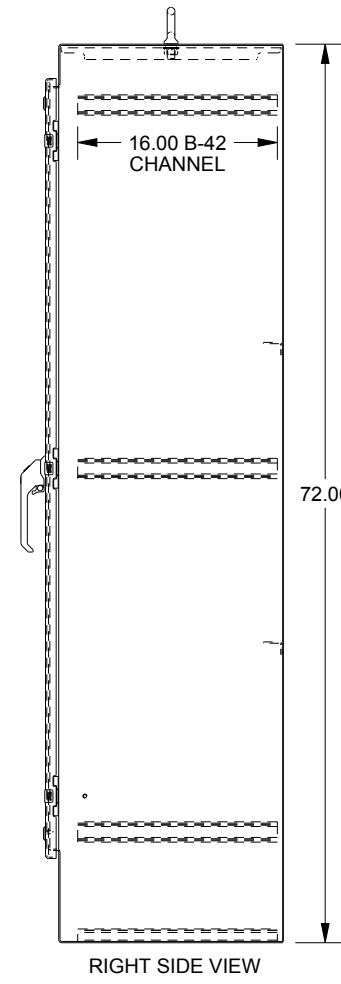
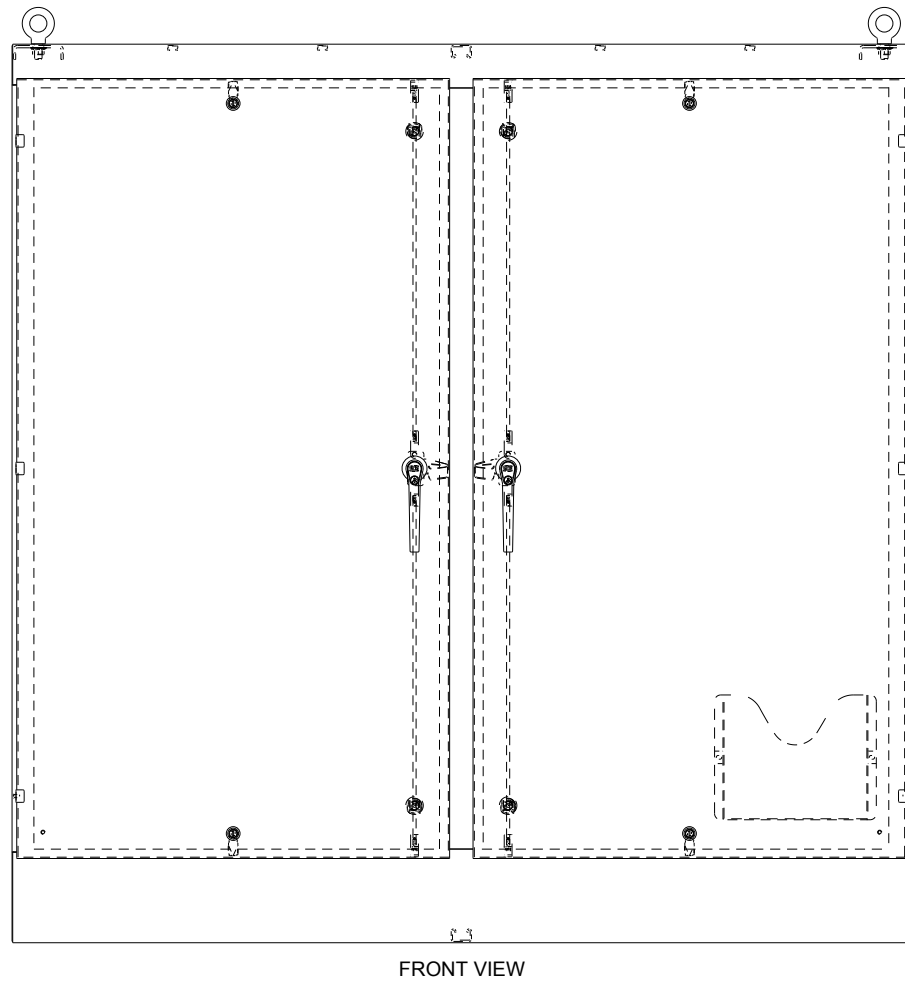
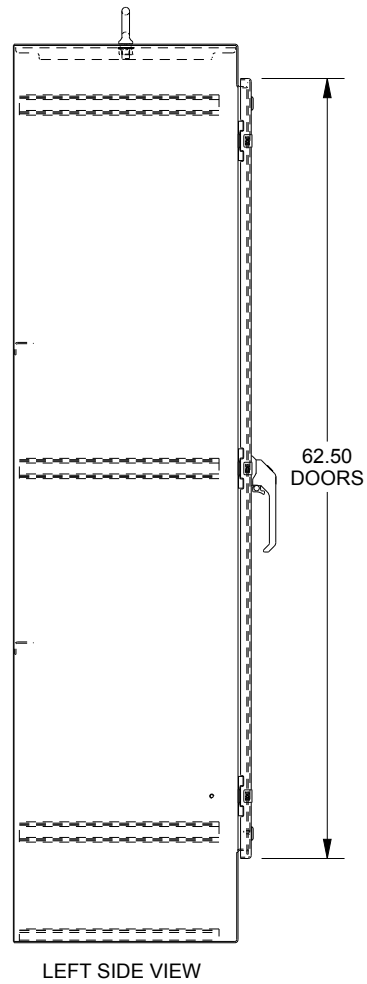
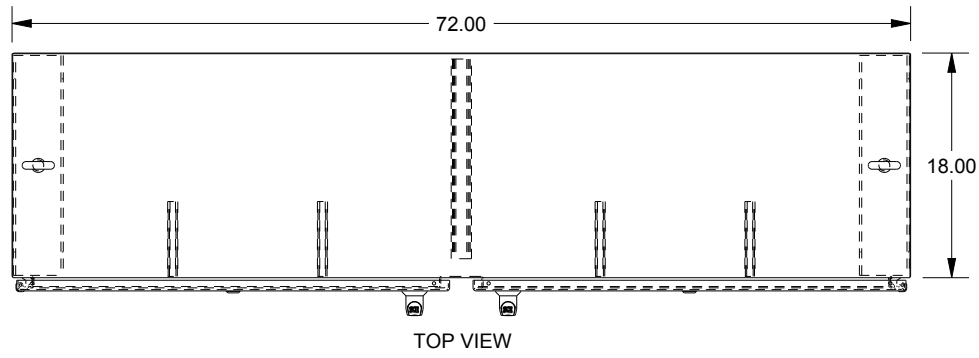

WASH SYSTEM 2" SQUARE DRAIN HOLES IN THE
BOTTOM WITH UL APPROVED HOLE SEALS PROVIDED