

SAGINAW CONTROL & ENGINEERING

SCE-72EL6024FSD

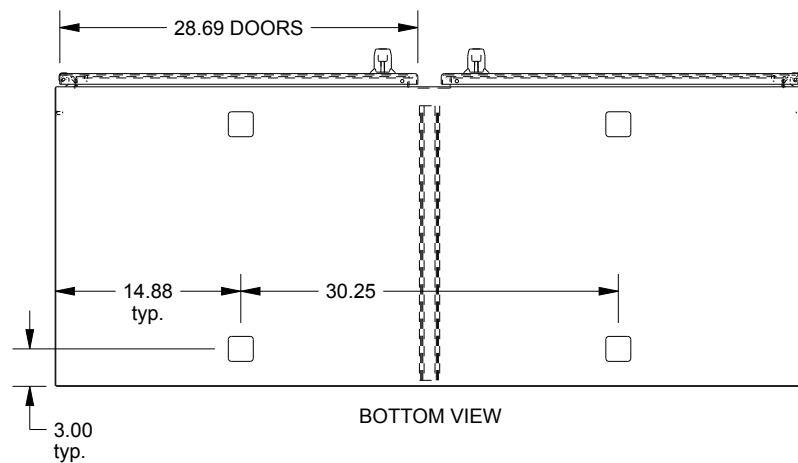
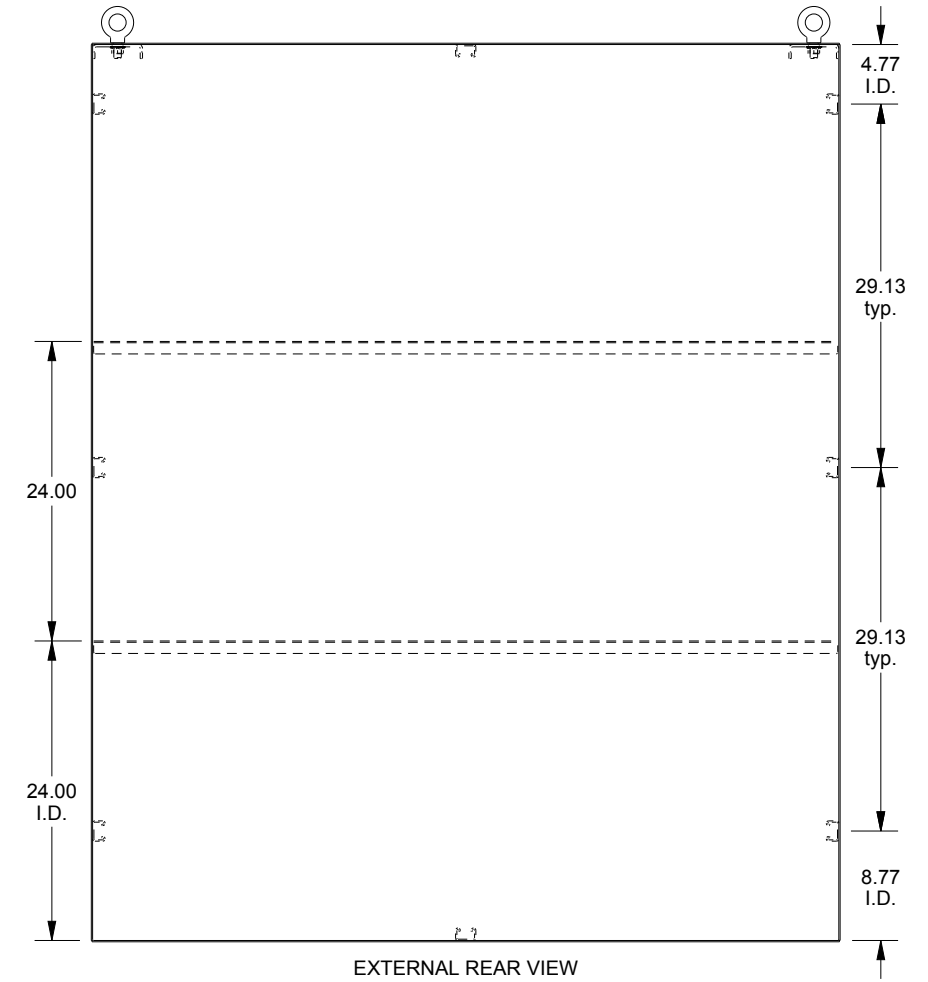
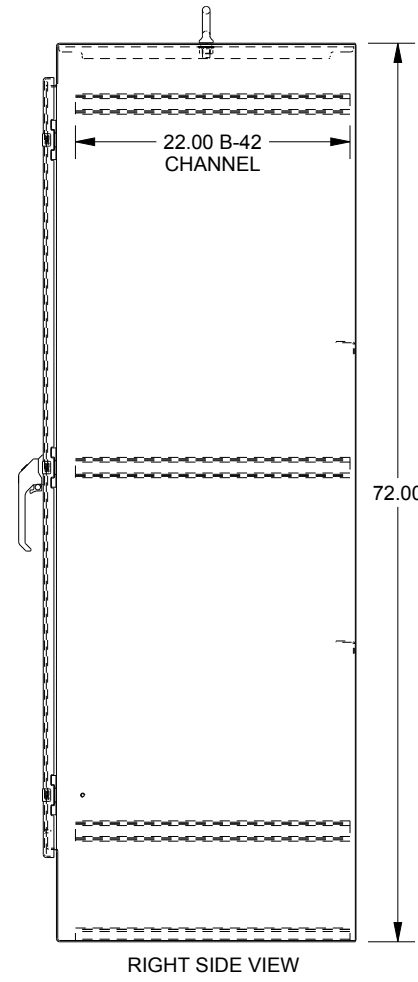
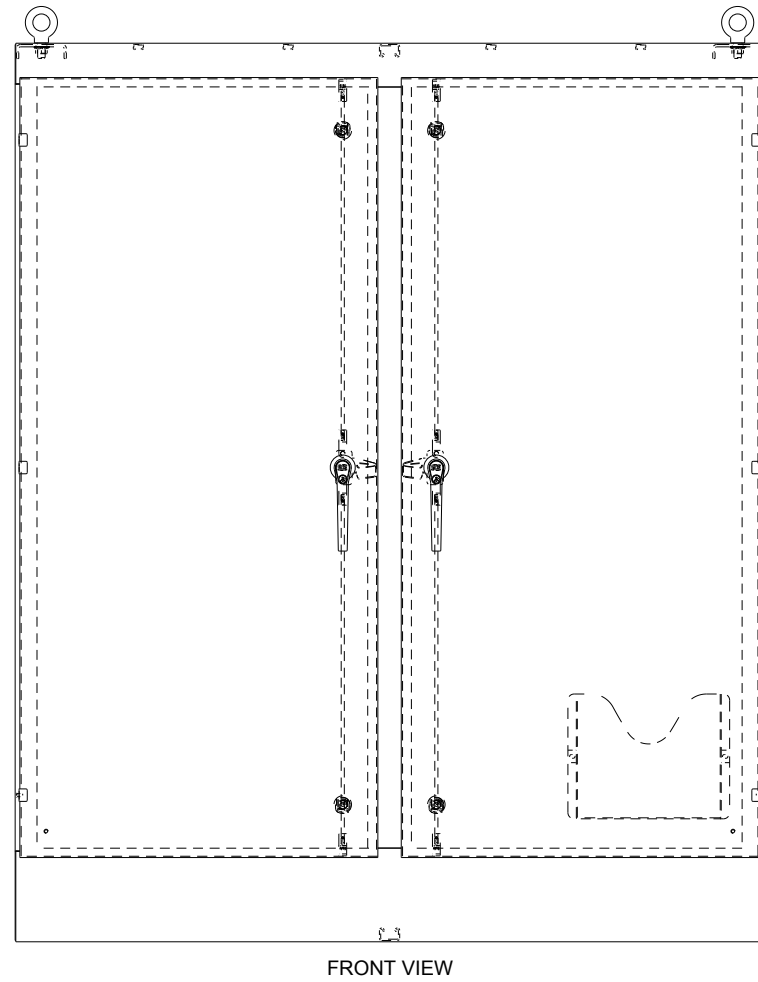
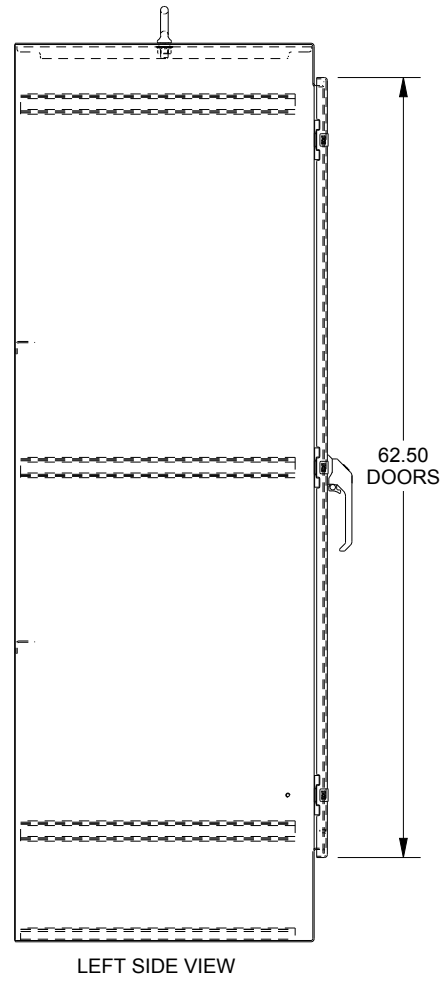
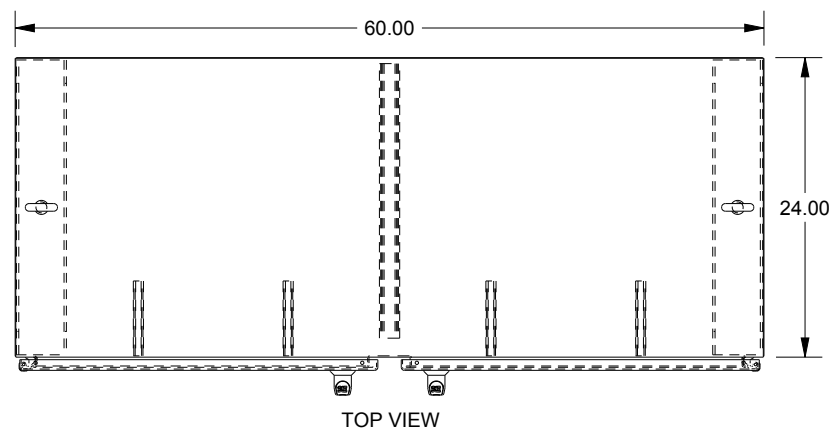

WASH SYSTEM 2" SQUARE DRAIN HOLES IN THE BOTTOM WITH UL APPROVED HOLE SEALS PROVIDED