

SAGINAW CONTROL & ENGINEERING SCE-72EL6018LPPL

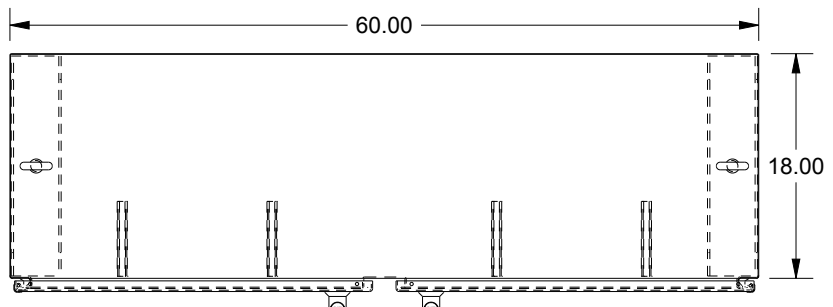

TOP VIEW

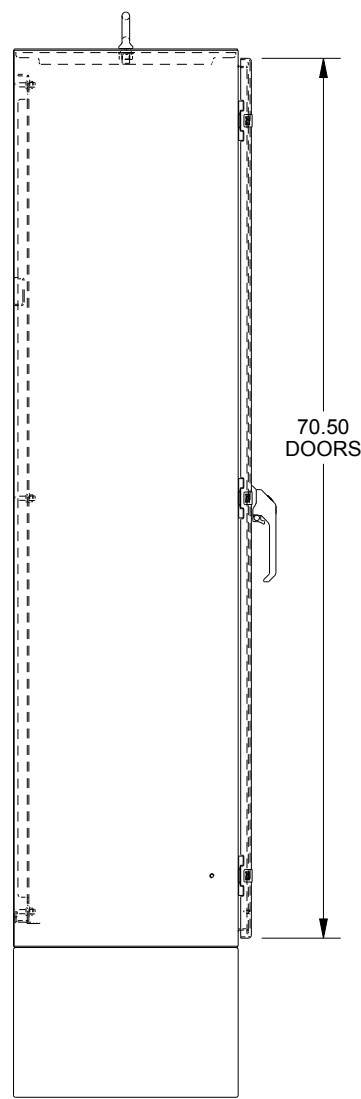

LEFT SIDE VIEW

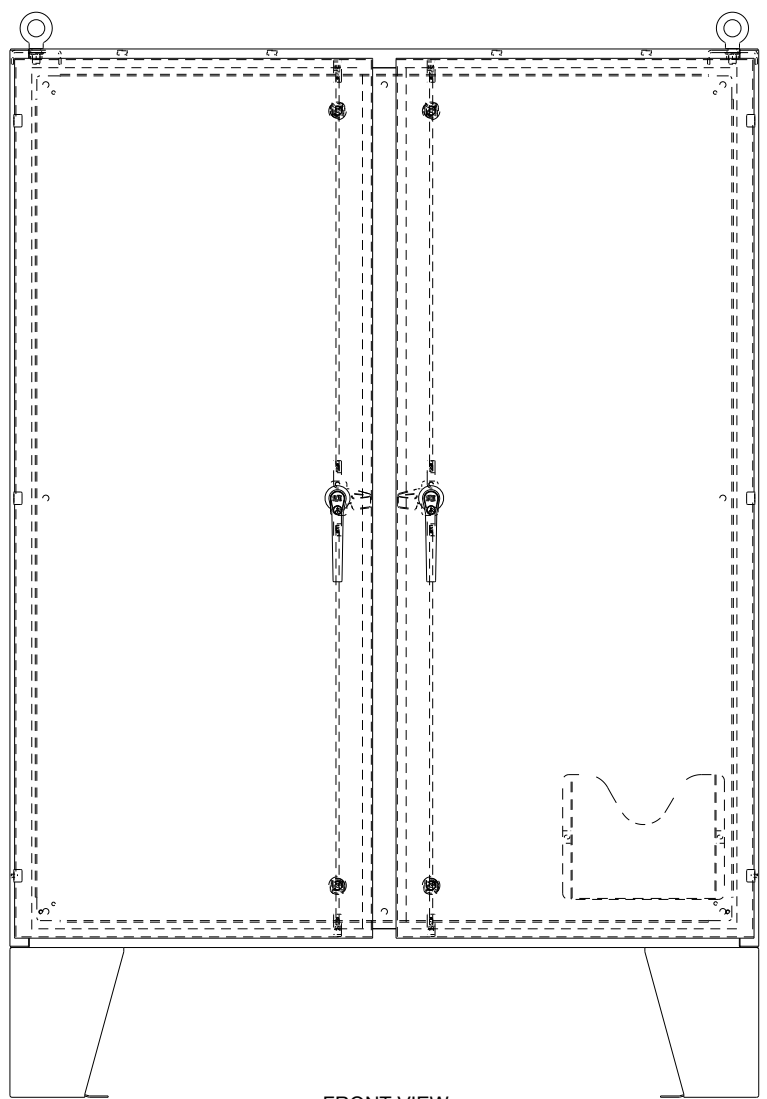

FRONT VIEW

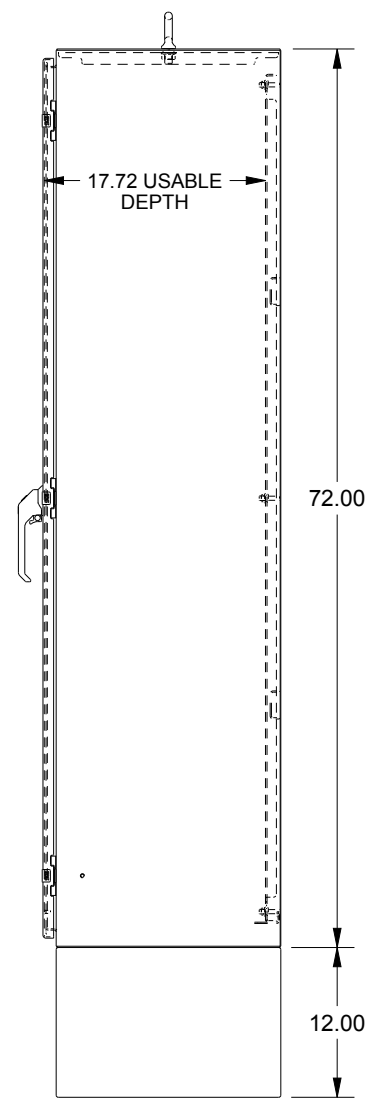

RIGHT SIDE VIEW

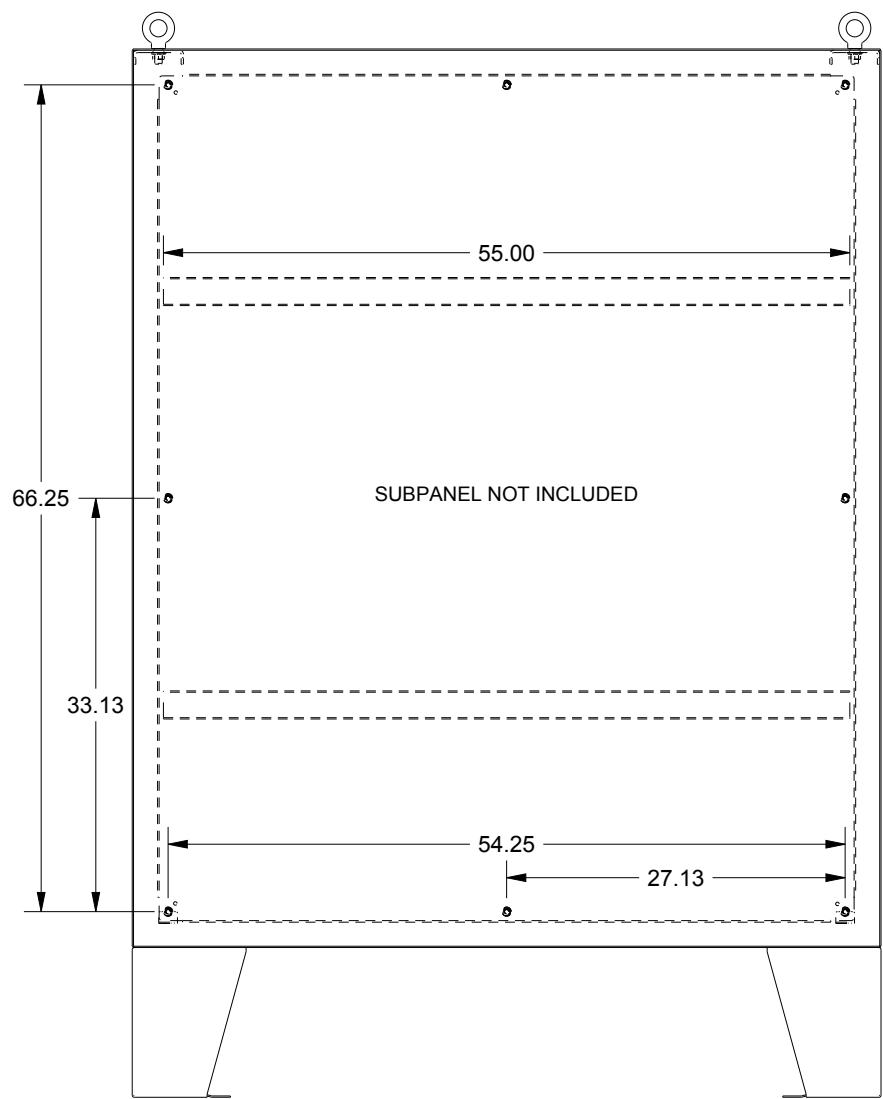

EXTERNAL REAR VIEW

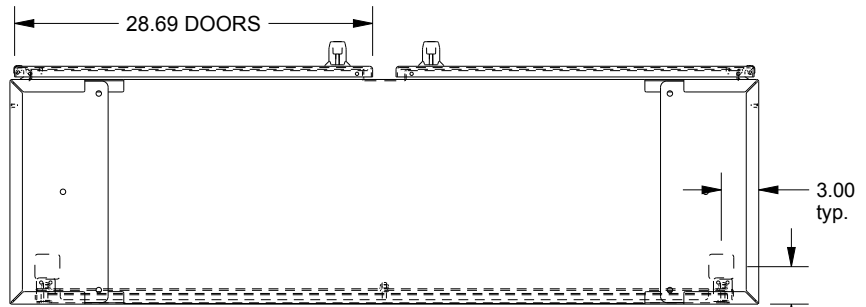

BOTTOM VIEW

WASH SYSTEM 2" SQUARE DRAIN HOLES IN THE
BOTTOM WITH UL APPROVED HOLE SEALS PROVIDED