

SAGINAW CONTROL & ENGINEERING SCE-727224FSD

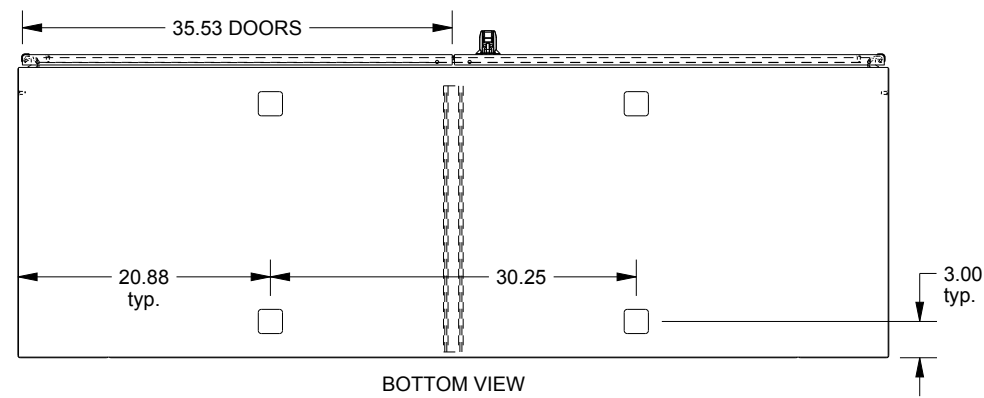
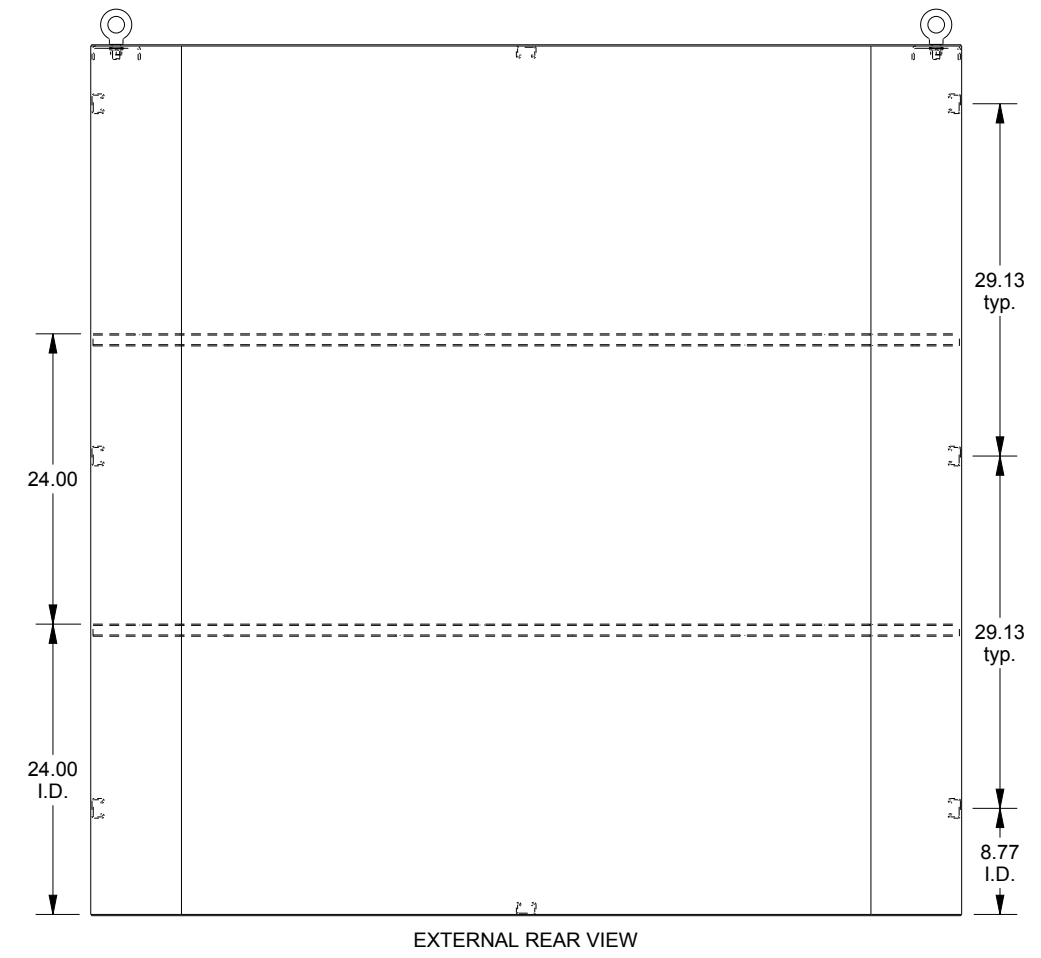
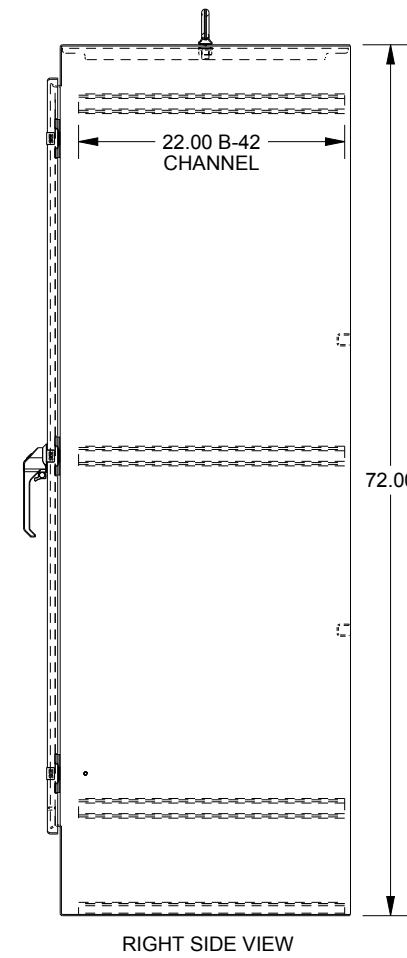
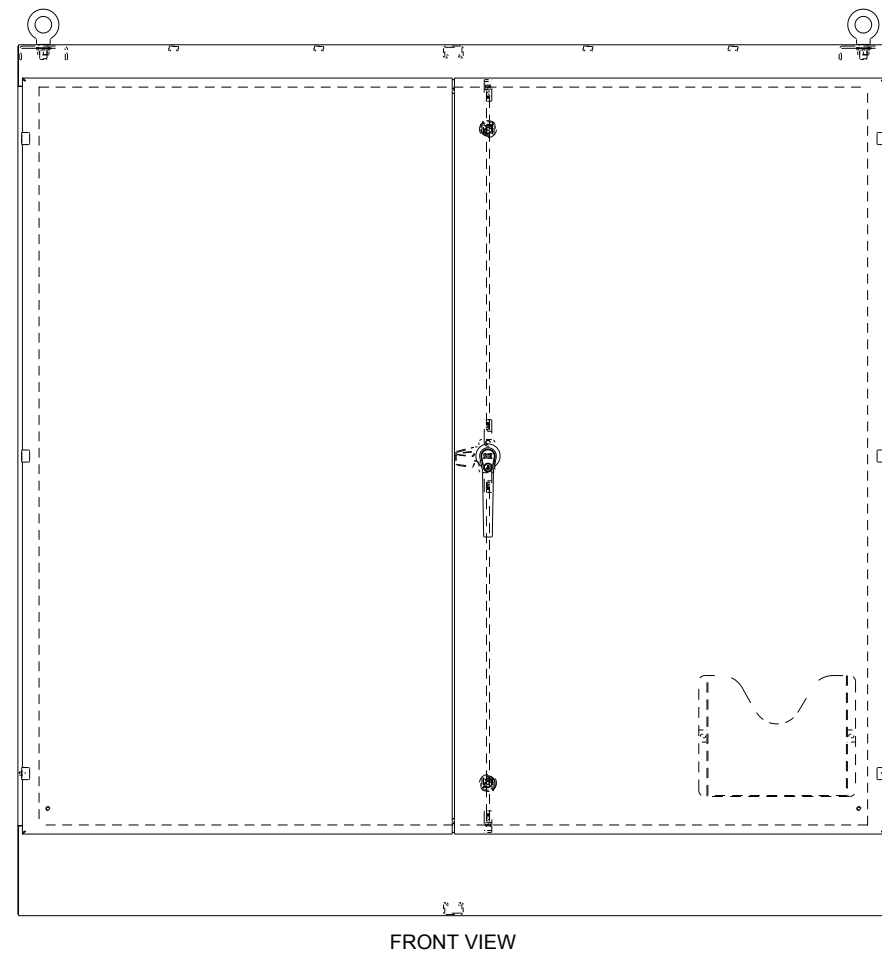
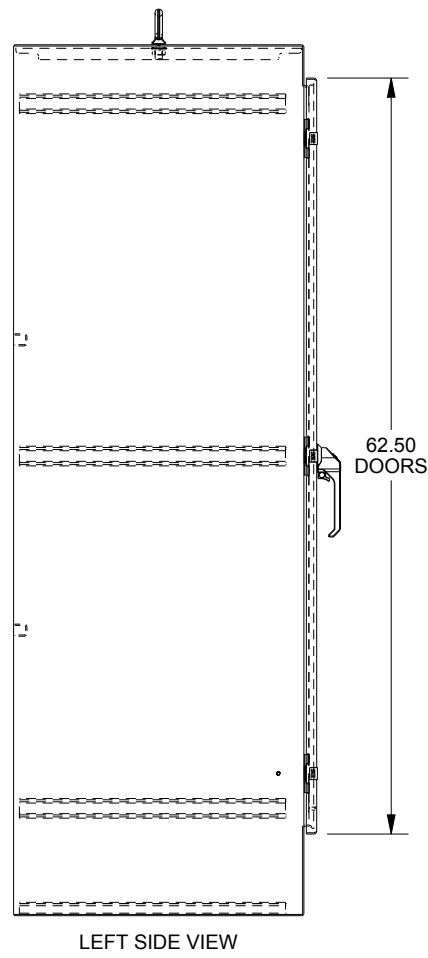
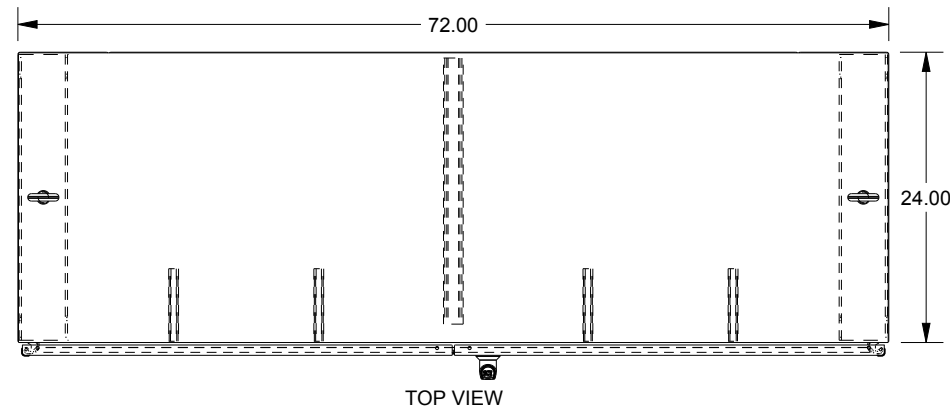

WASH SYSTEM 2" SQUARE DRAIN HOLES IN THE
BOTTOM WITH UL APPROVED HOLE SEALS PROVIDED