

SAGINAW CONTROL & ENGINEERING

SCE-48XEL3716LP = SCE-09 GRAY
 SCE-48XEL3716LPLG = RAL 7035

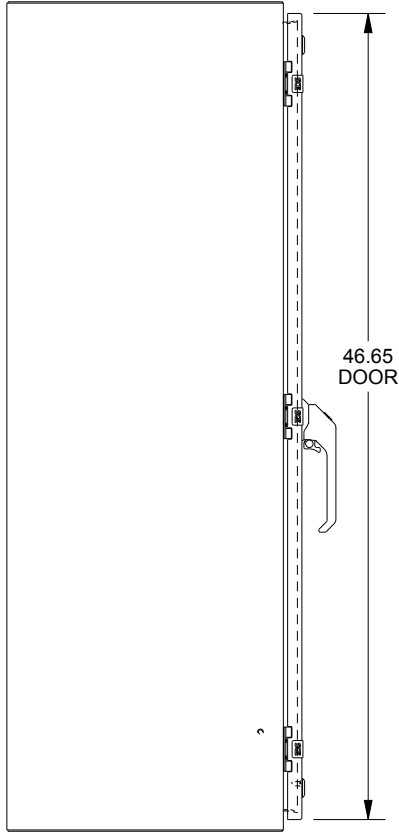

LEFT SIDE VIEW

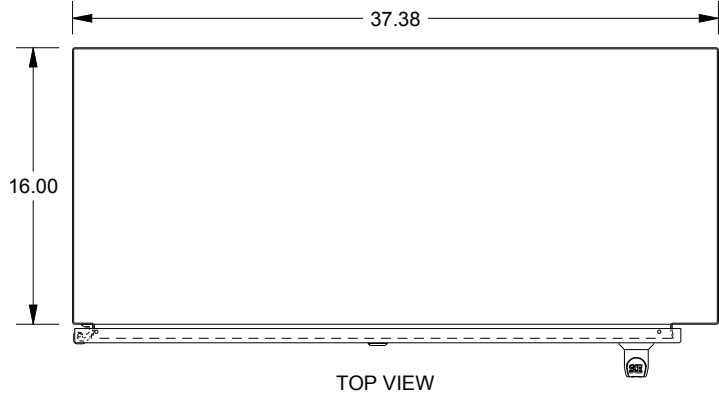
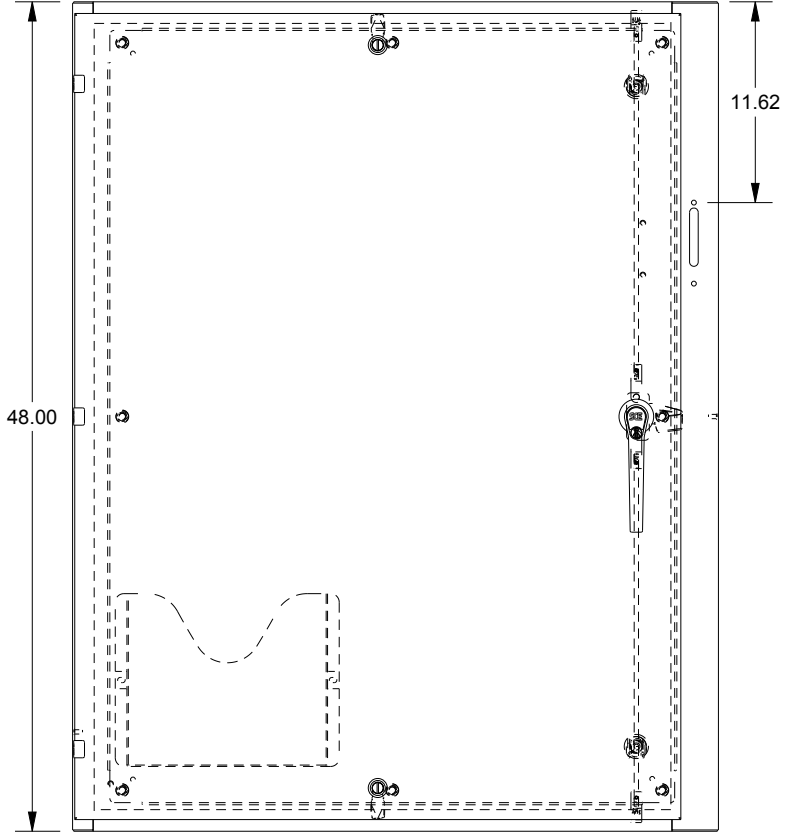

FRONT VIEW

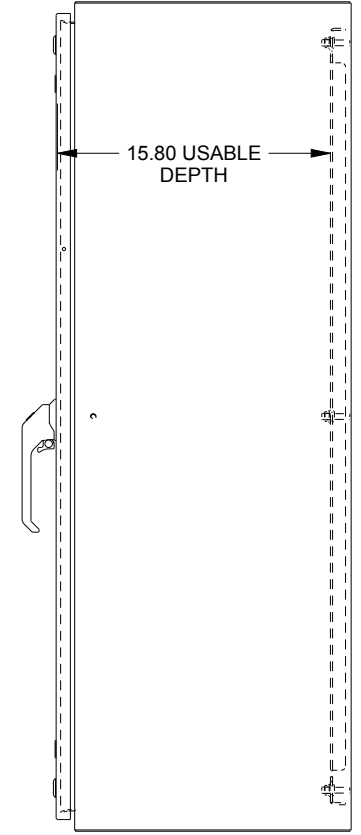

RIGHT SIDE VIEW

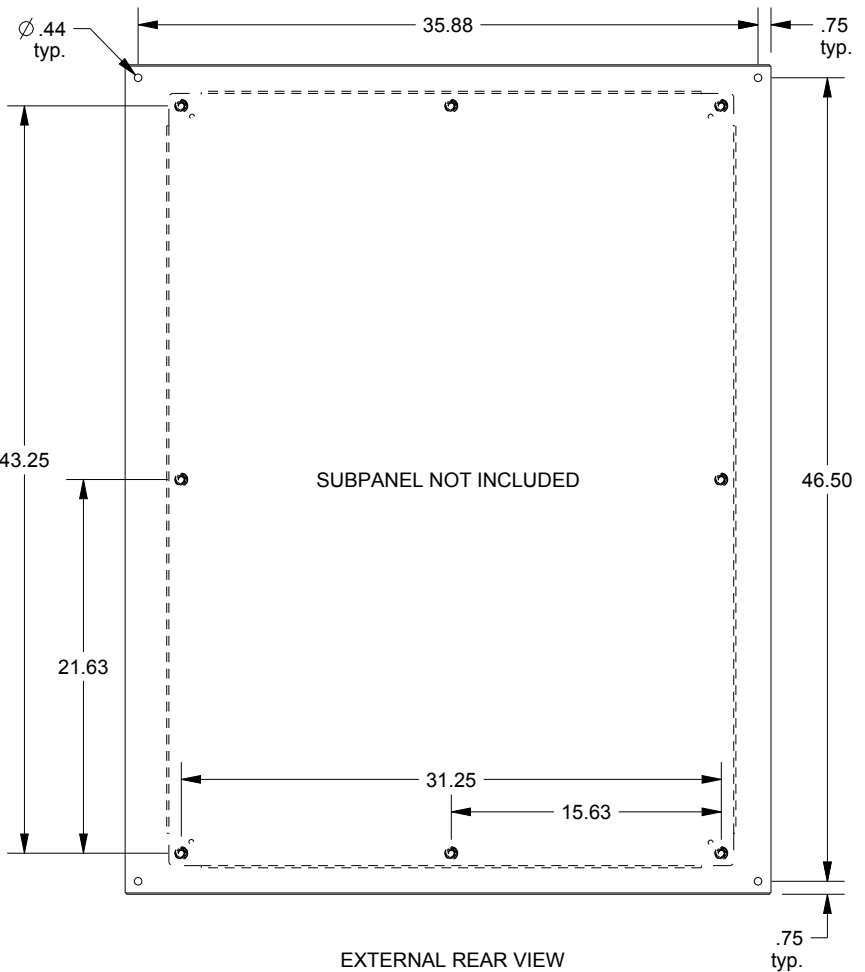

EXTERNAL REAR VIEW

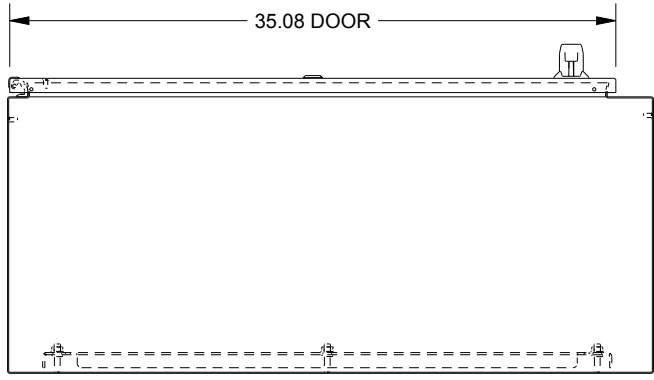

BOTTOM VIEW