

SAGINAW CONTROL & ENGINEERING

SCE-48XEL3712LP = SCE-09 GRAY
 SCE-48XEL3712LPLG = RAL 7035

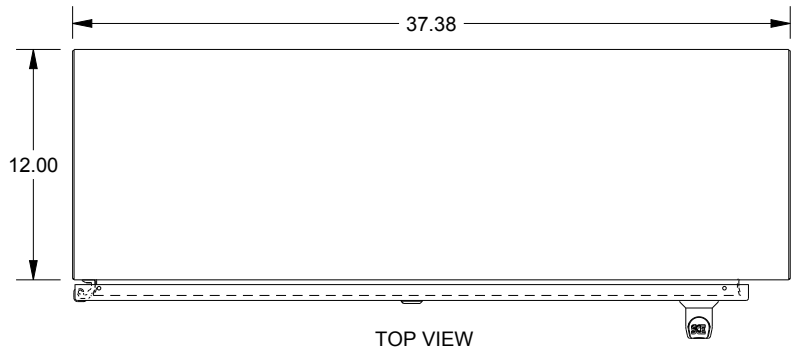

TOP VIEW

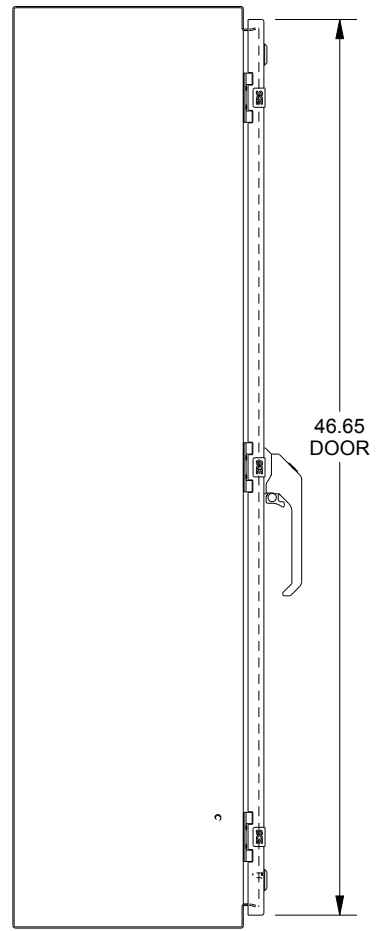

LEFT SIDE VIEW

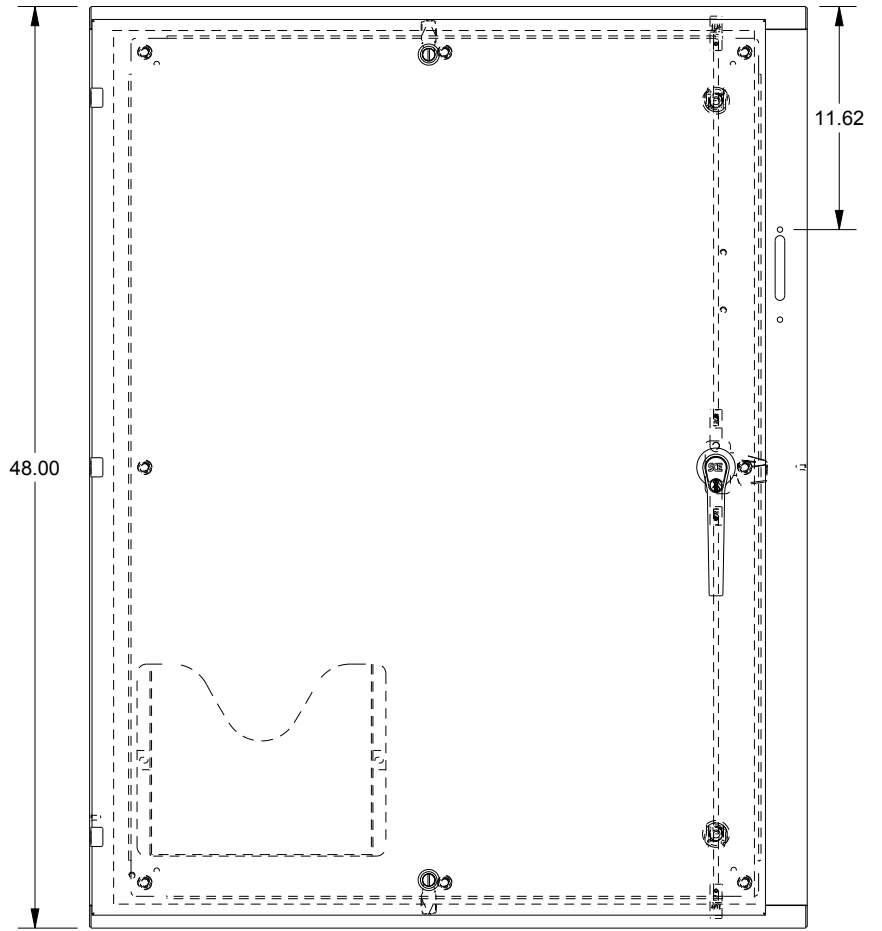

FRONT VIEW

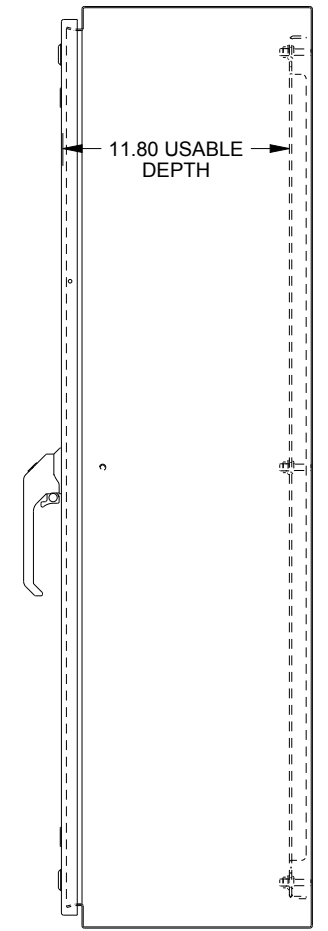

RIGHT SIDE VIEW

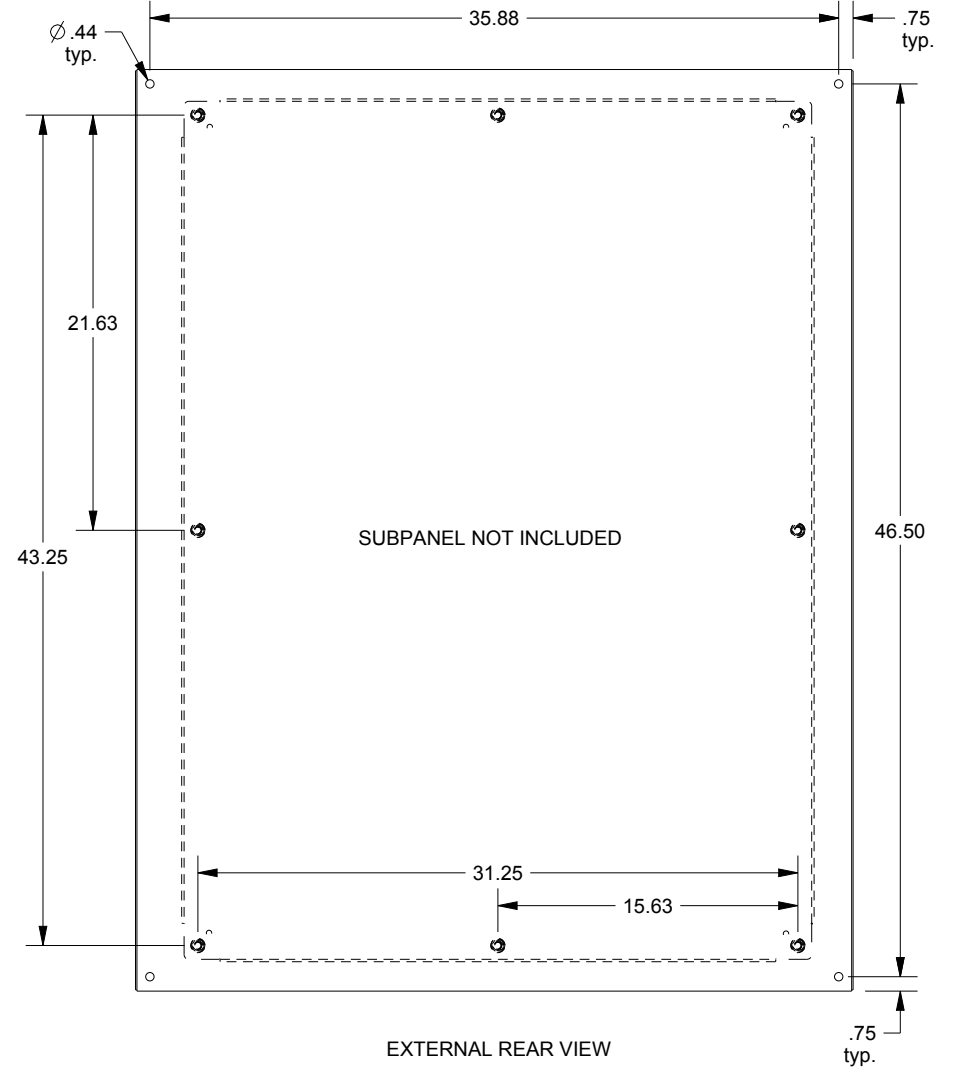

EXTERNAL REAR VIEW

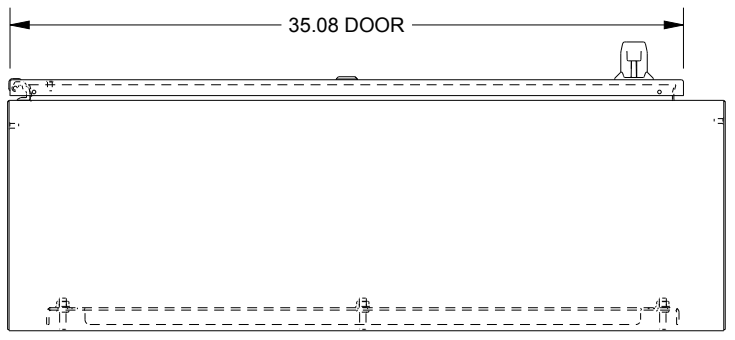

BOTTOM VIEW