

SAGINAW CONTROL & ENGINEERING

SCE-42XEL3110LP = SCE-09 GRAY
 SCE-42XEL3110LPLG = RAL 7035

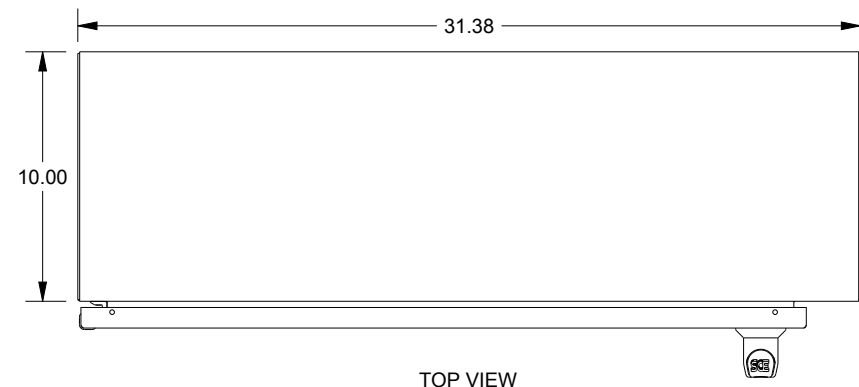

TOP VIEW

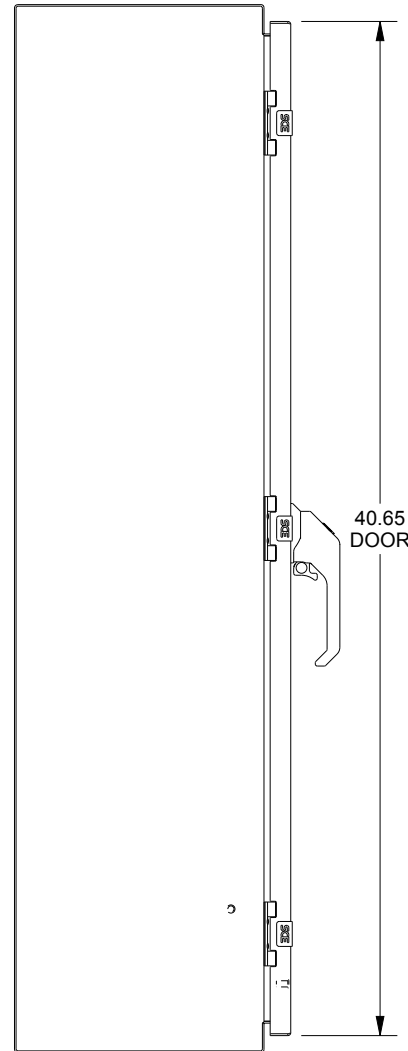

LEFT SIDE VIEW

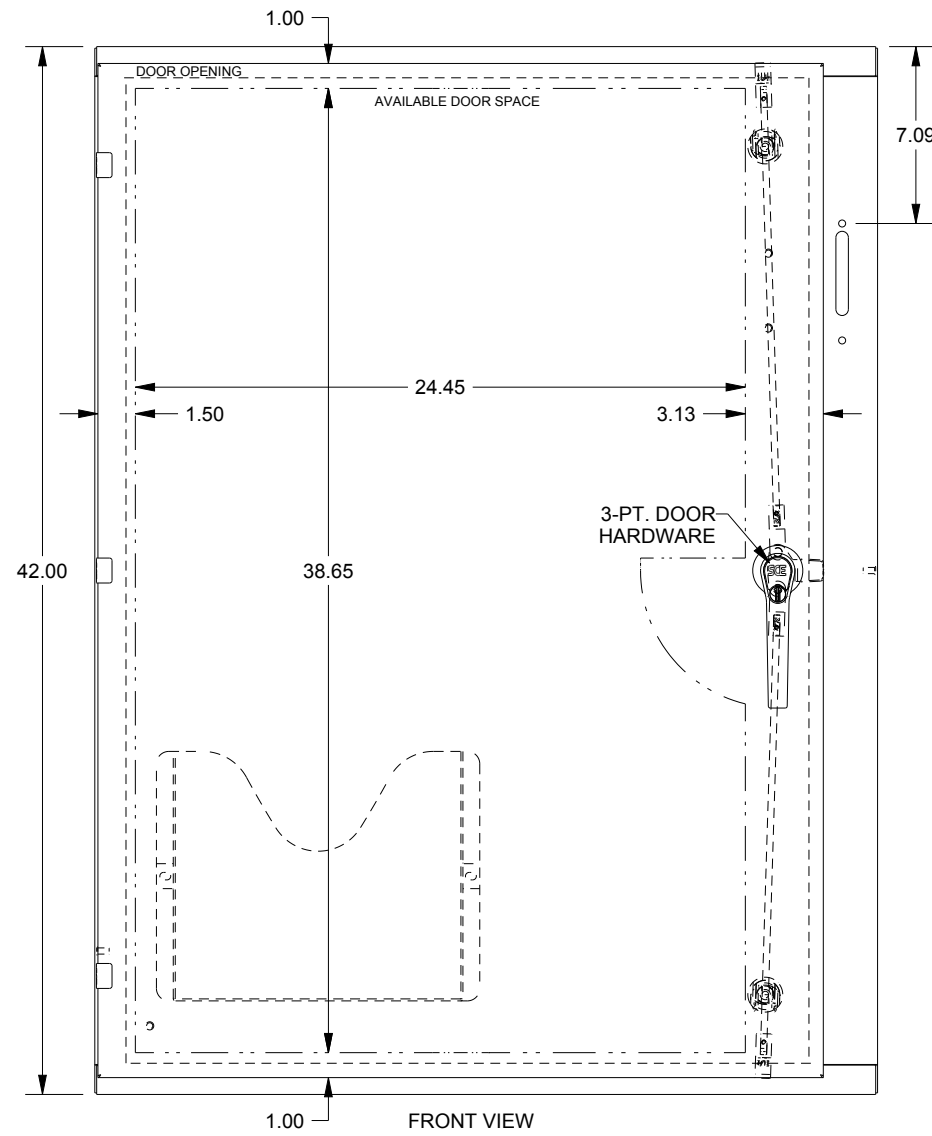

FRONT VIEW

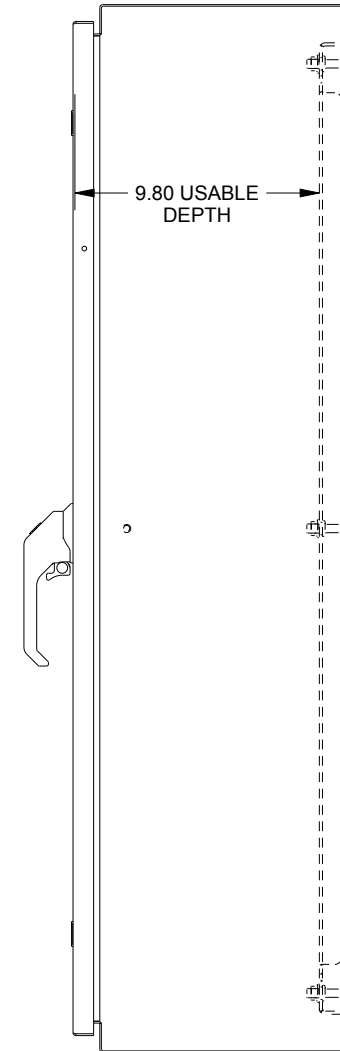

RIGHT SIDE VIEW

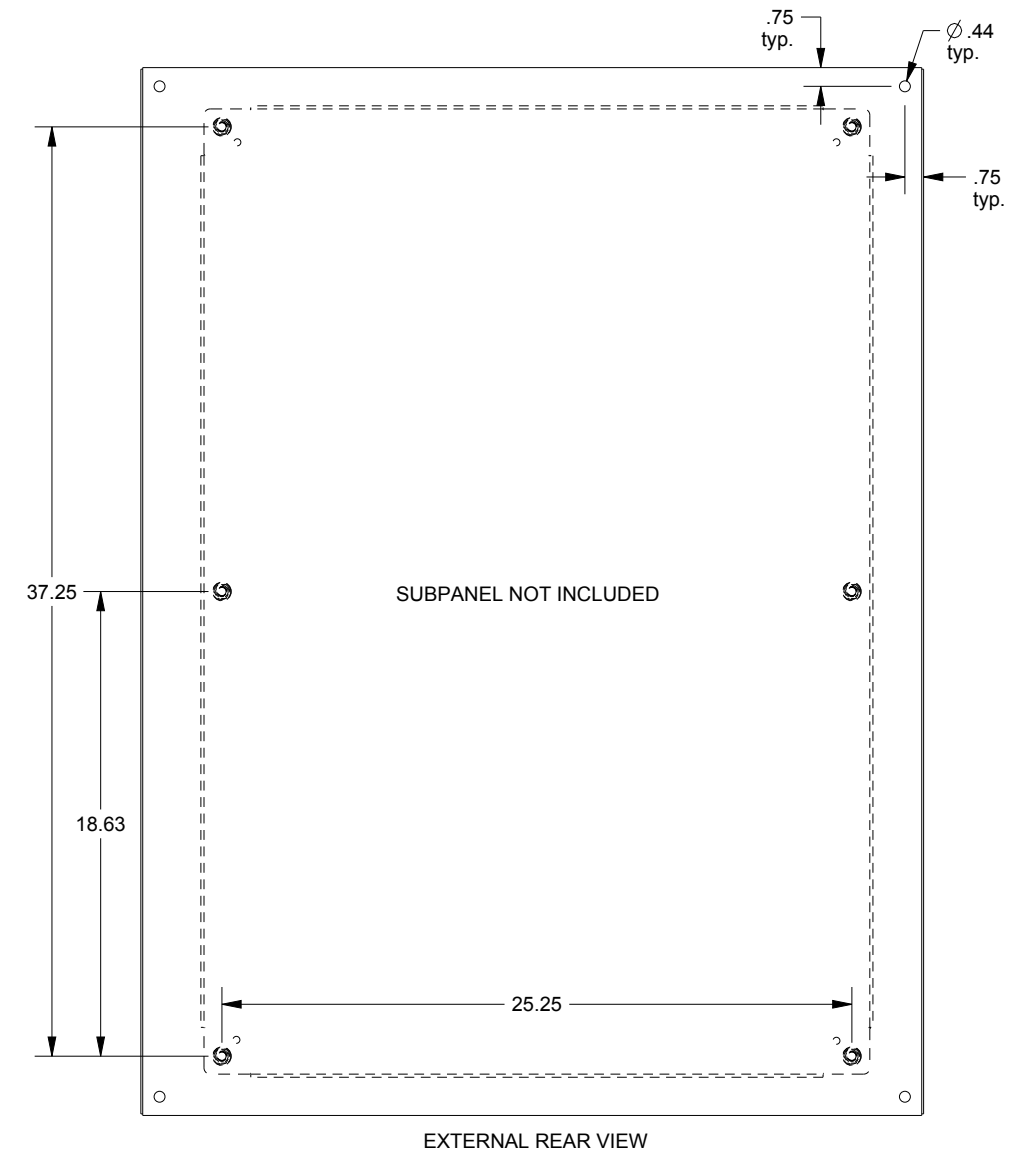

EXTERNAL REAR VIEW

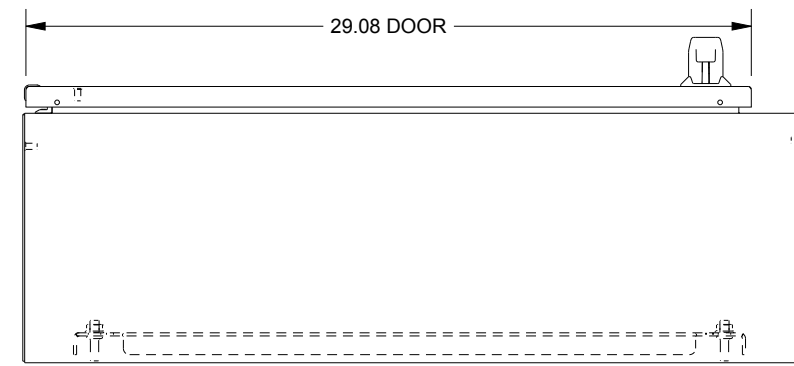

BOTTOM VIEW