

SAGINAW CONTROL & ENGINEERING SCE-3PBX

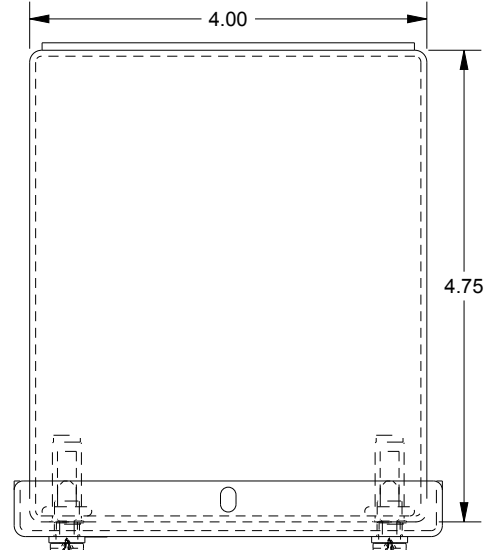

TOP VIEW

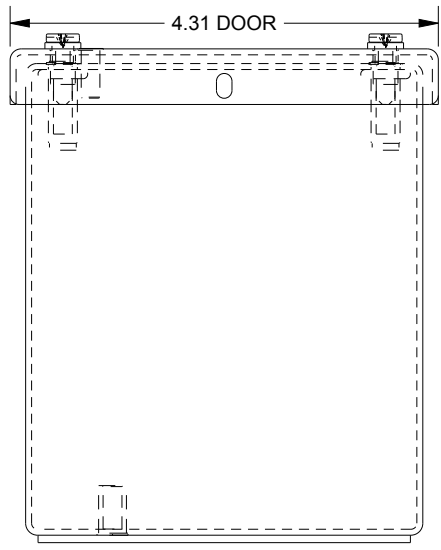

BOTTOM VIEW

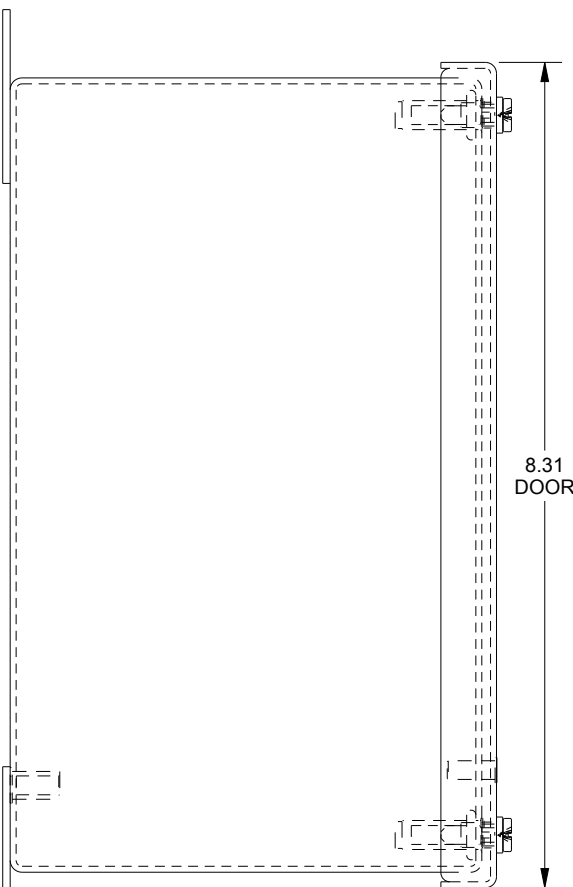

LEFT SIDE VIEW

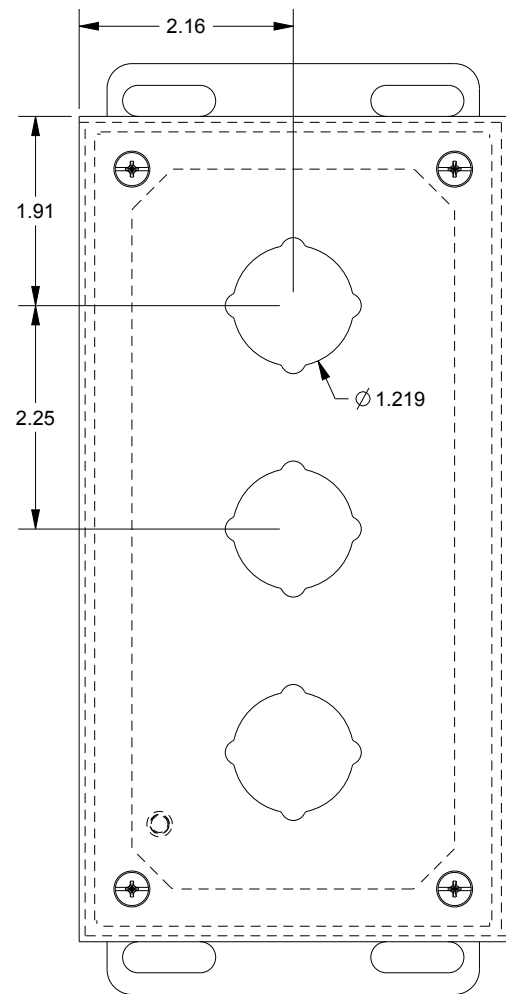

FRONT VIEW

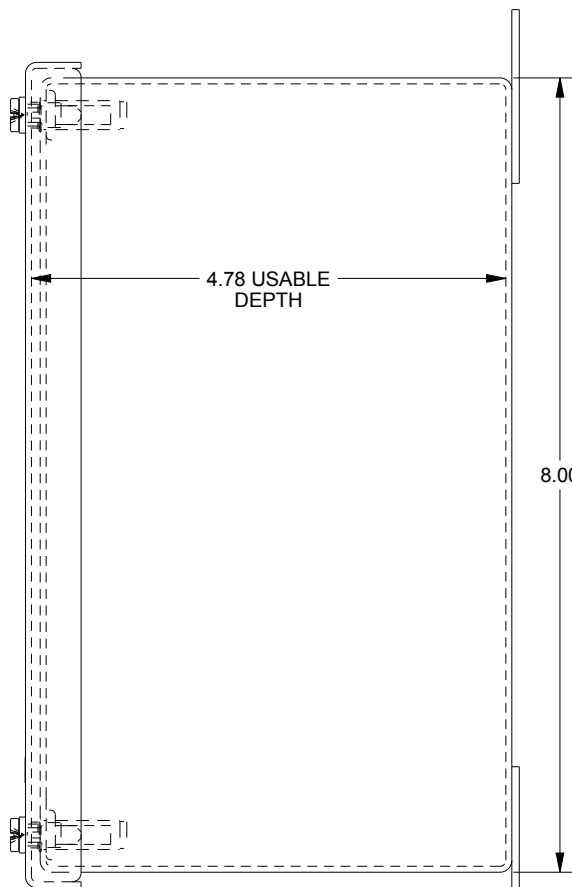

RIGHT SIDE VIEW

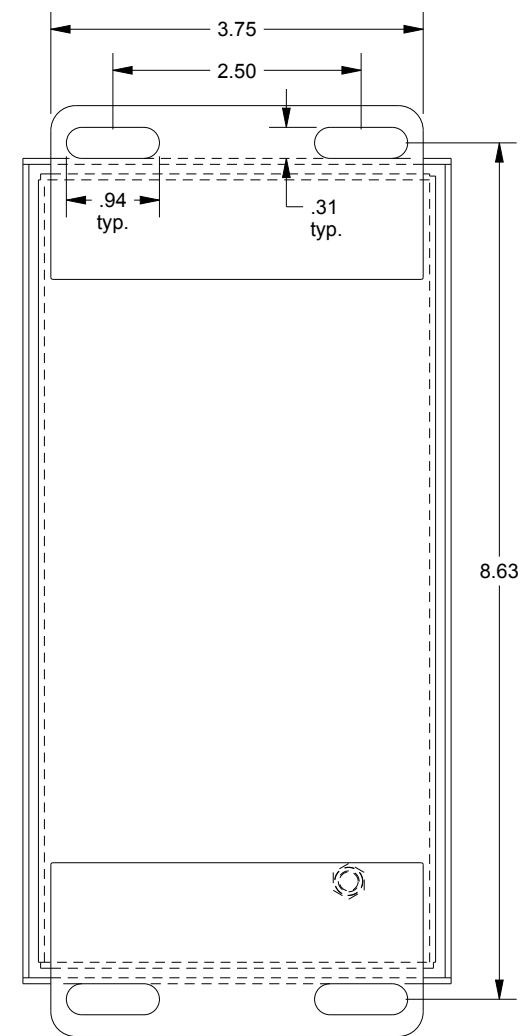

EXTERNAL REAR VIEW