

SAGINAW CONTROL & ENGINEERING

SCE-3PBA

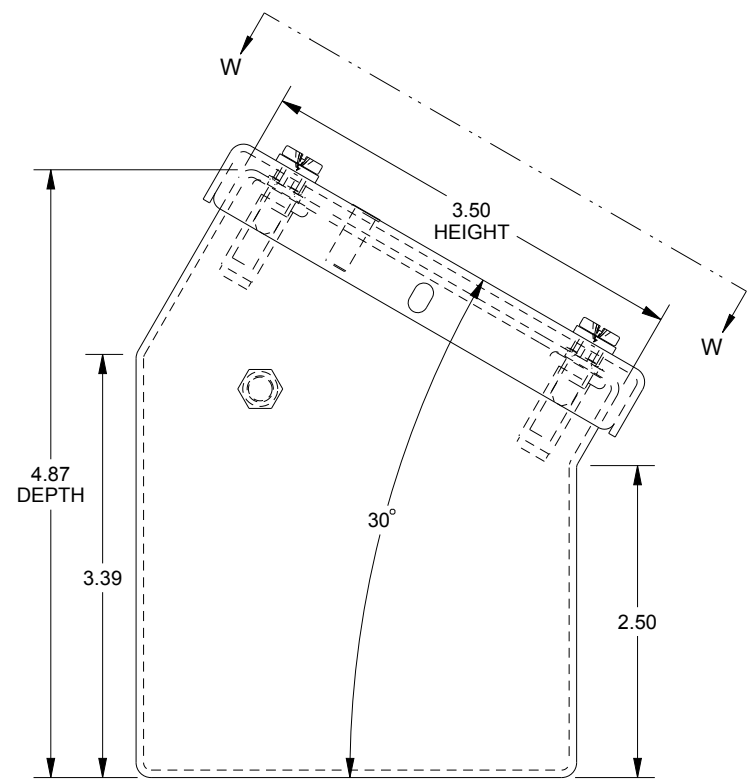

REAR VIEW



LEFT SIDE VIEW

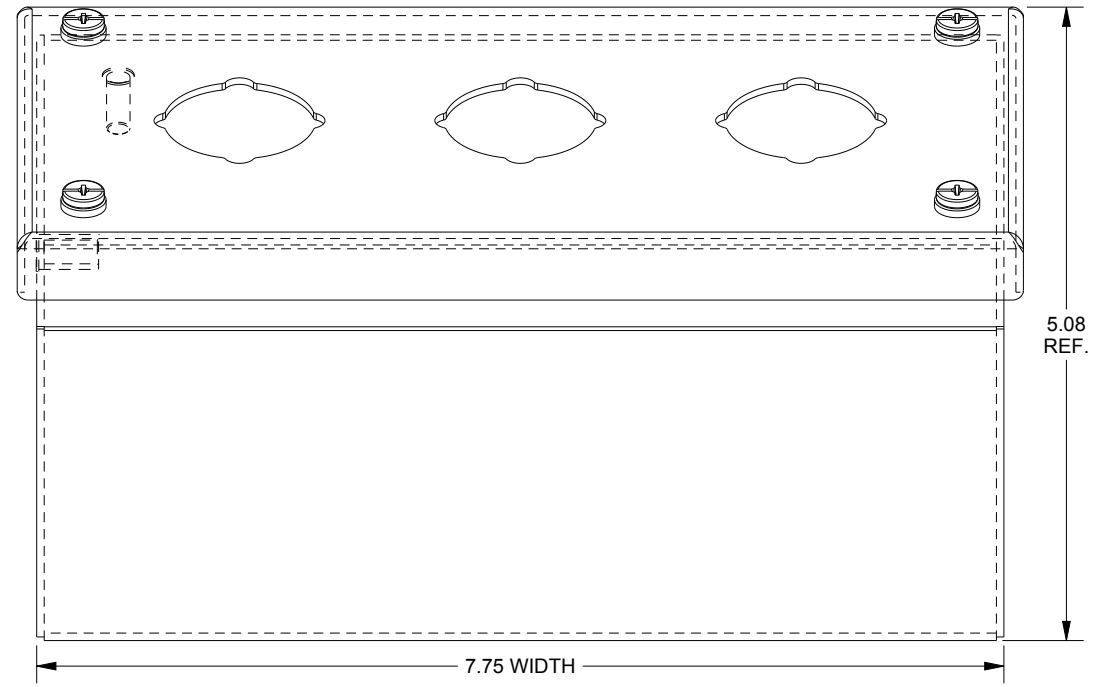

FRONT VIEW

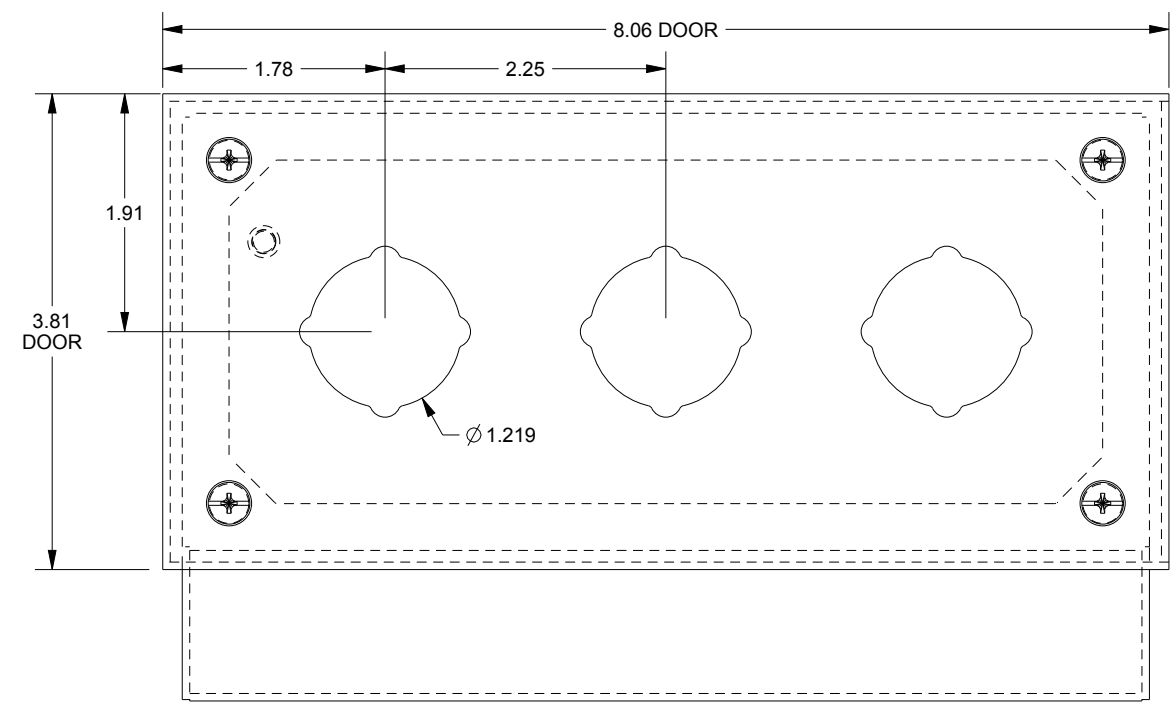

SECTION W-W

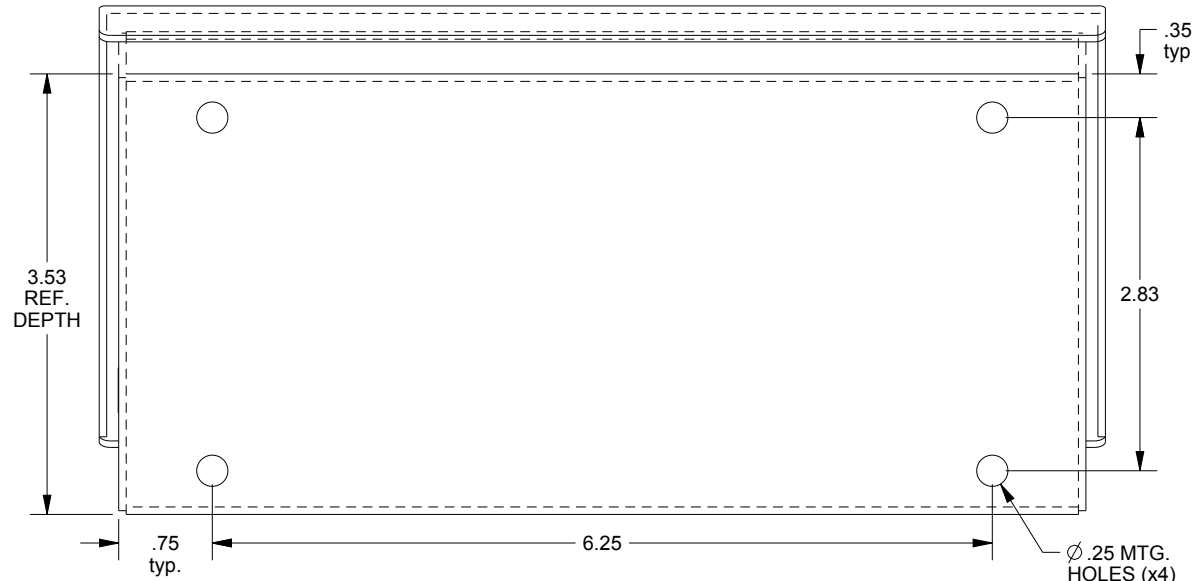

BOTTOM VIEW