

BILL OF MATERIAL

ITEM	QTY	PART DESCRIPTION	PART I.D.
1	1	Subpanel	NA

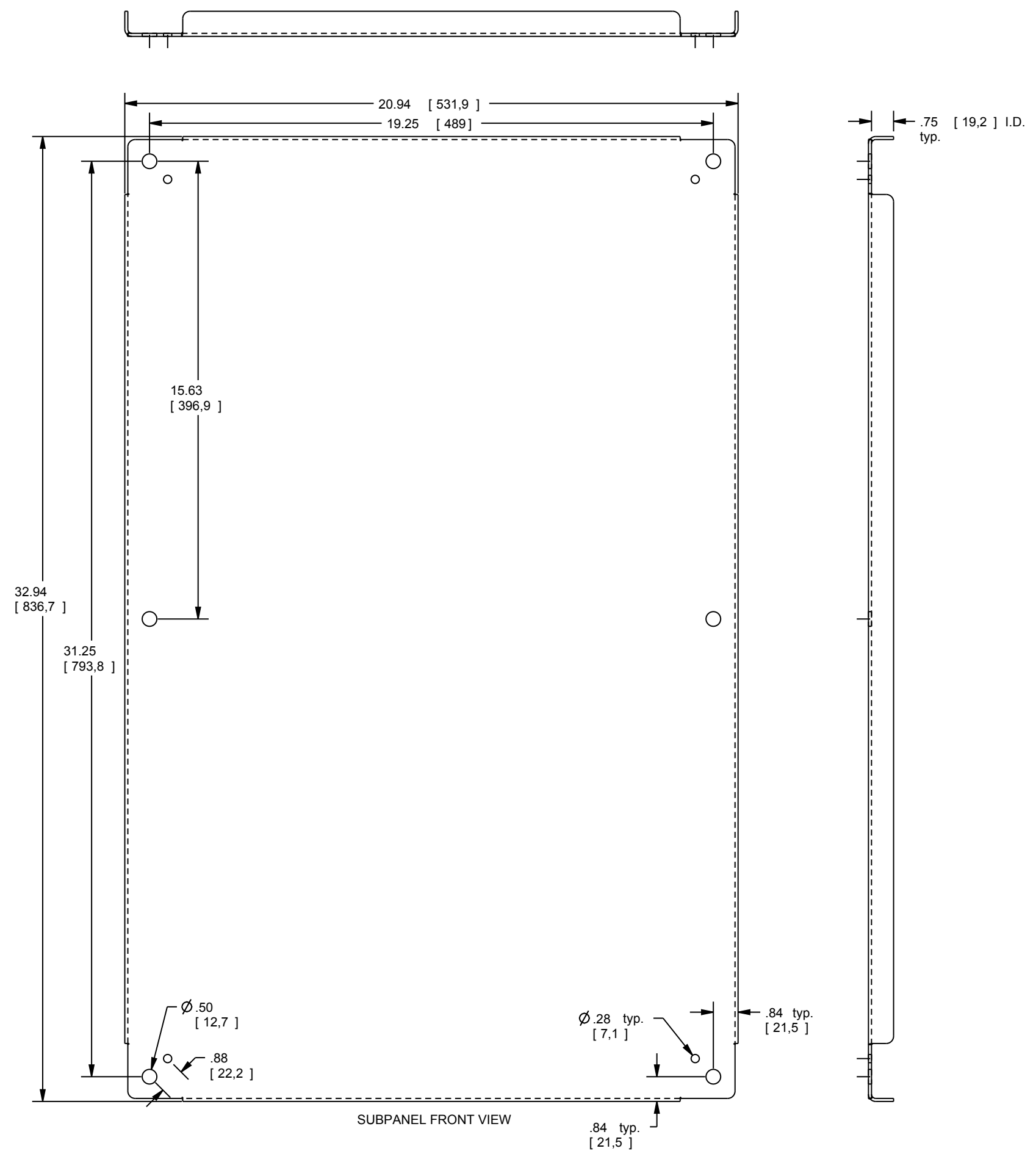

The material contained herein is the exclusive property of Saginaw Control & Engineering and must be returned to Saginaw Control & Engineering upon request. The information and material contained herein may not be copied, reproduced, used or transmitted in whole or in part in any way without the prior written consent of Saginaw Control & Engineering.

PART NUMBER: SCE-36P24SS	REV: --
12GA. #4 BRUSHED STAINLESS STEEL TYPE 316 MATERIAL	
SHEET: 1 OF 1	

SAGINAW CONTROL & ENGINEERING
ISO 9001:2000 Certified Company



Corporate Office:
95 Midland Road
Saginaw, Michigan 48638-5770
(989) 799-6871
Fax (989) 799-4524
(800) 234-6871
<http://www.saginawcontrol.com>
E-mail: sce@saginawcontrol.com

Your Enclosure Source