

SAGINAW CONTROL & ENGINEERING

SCE-36N2408LP

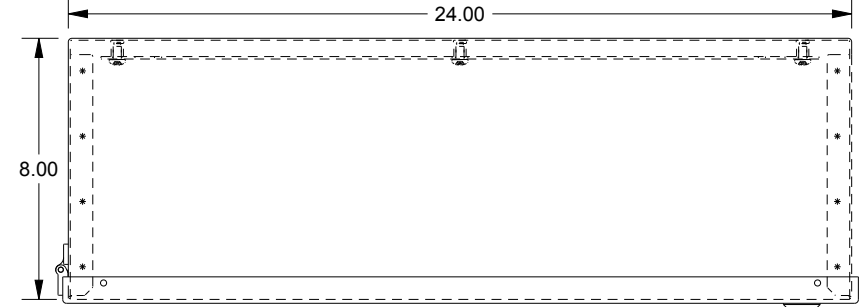

TOP VIEW

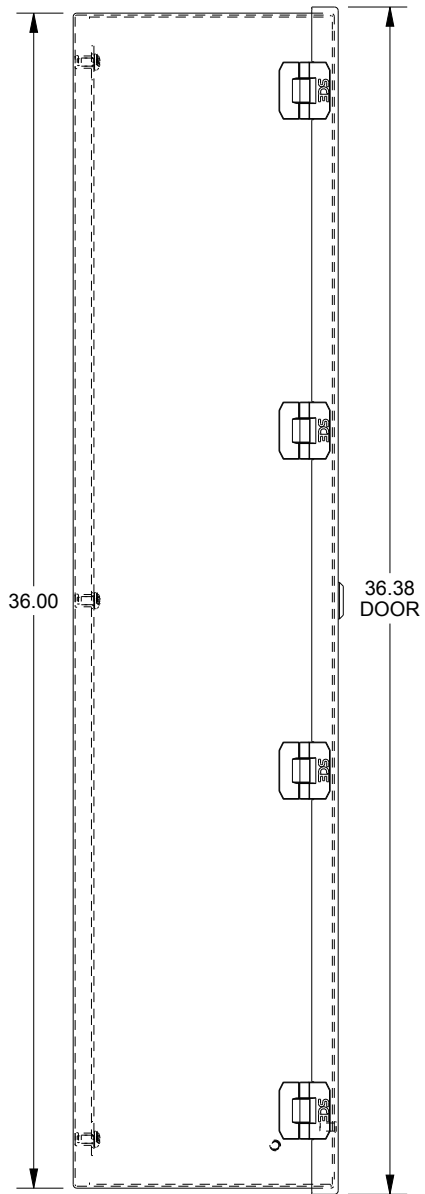

LEFT SIDE VIEW

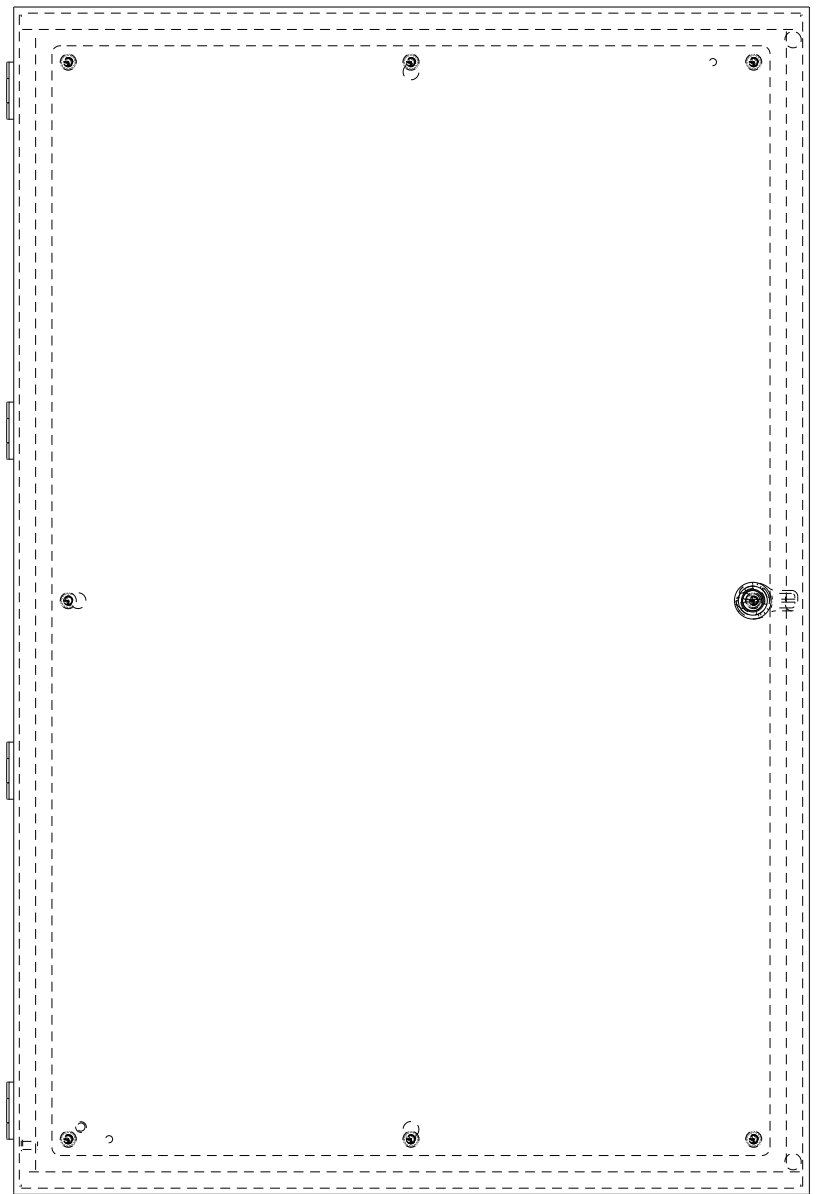

FRONT VIEW

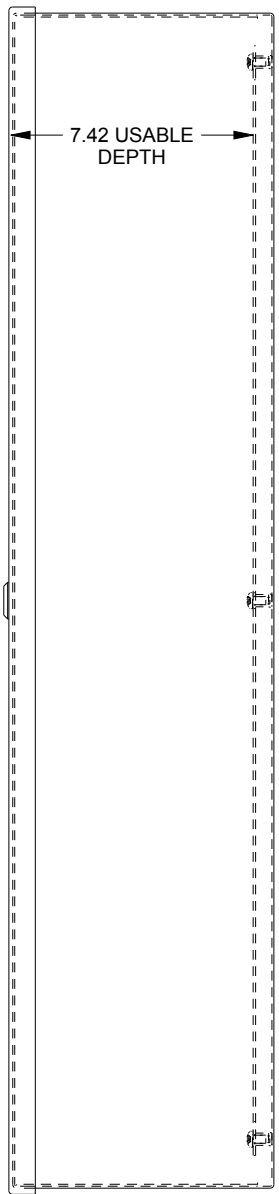

RIGHT SIDE VIEW

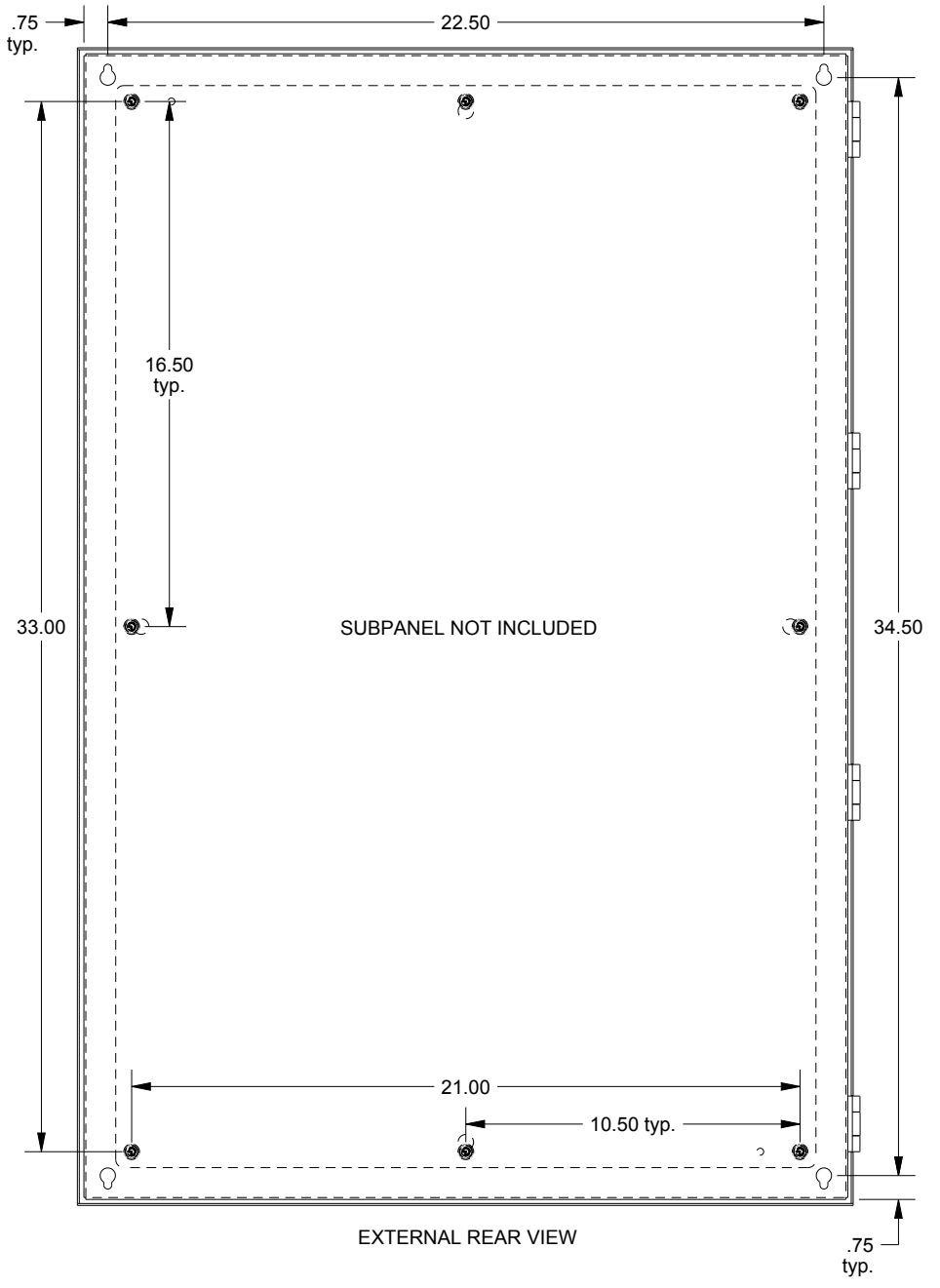

EXTERNAL REAR VIEW

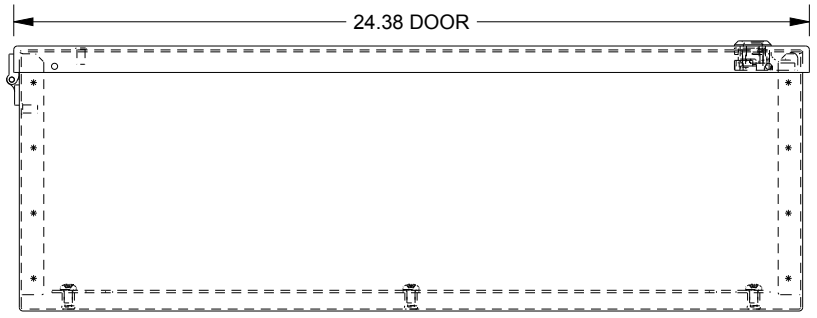

BOTTOM VIEW

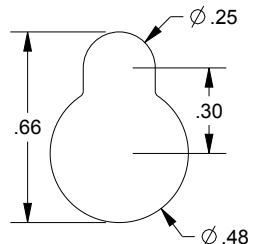

MOUNTING HOLE DETAIL (4plcs.)