

SAGINAW CONTROL & ENGINEERING SCE-24H1208LP

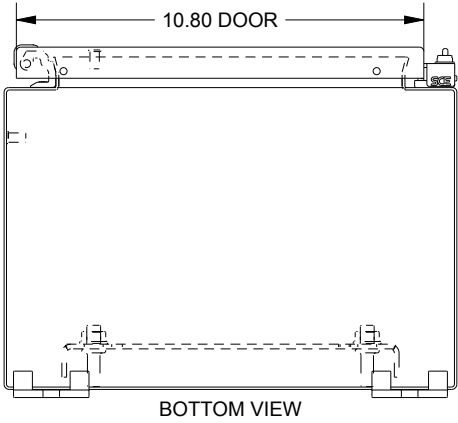

BOTTOM VIEW

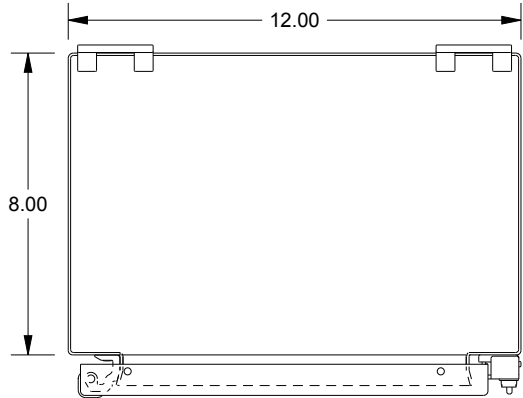

TOP VIEW

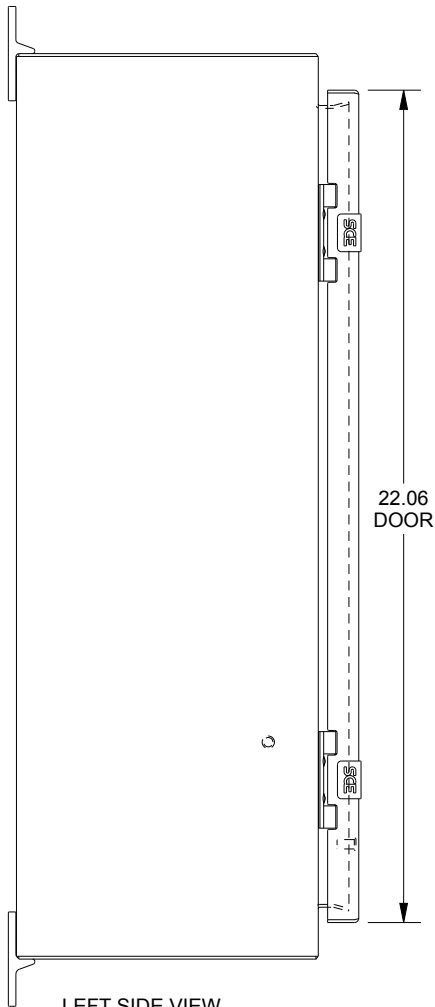

LEFT SIDE VIEW

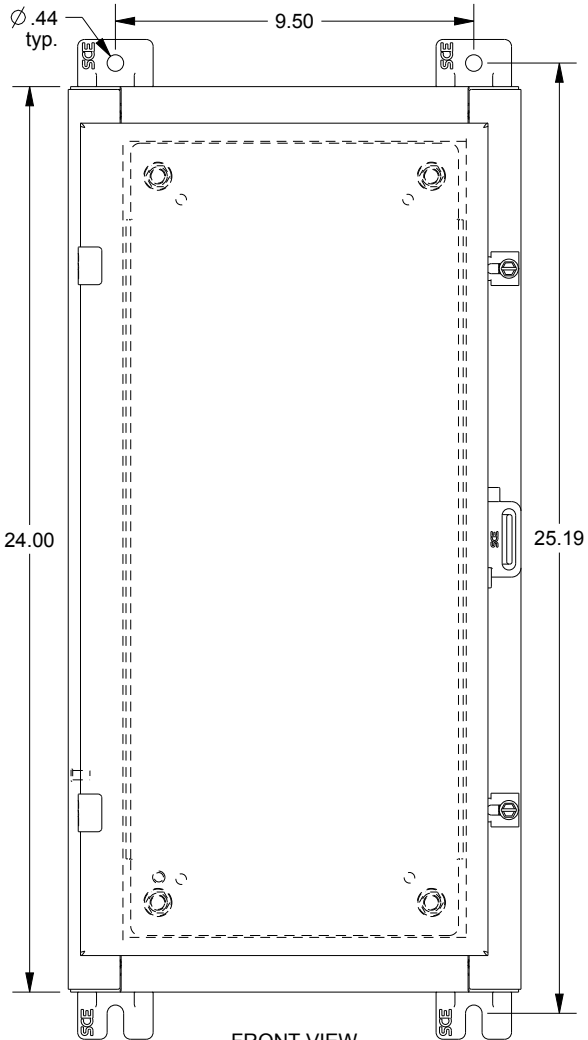

FRONT VIEW

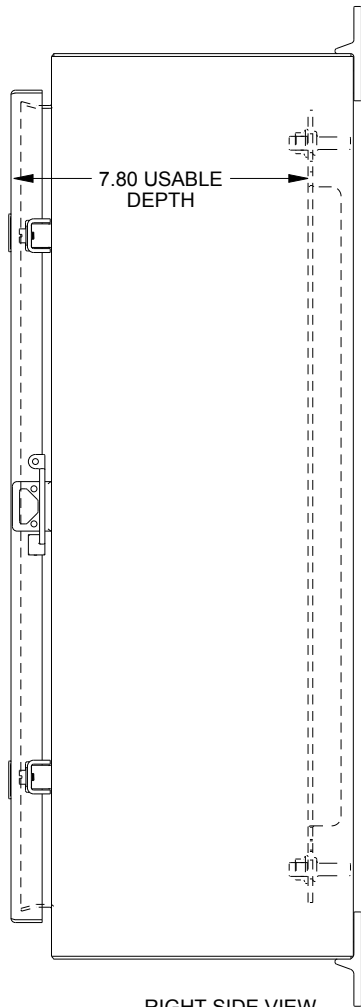

RIGHT SIDE VIEW

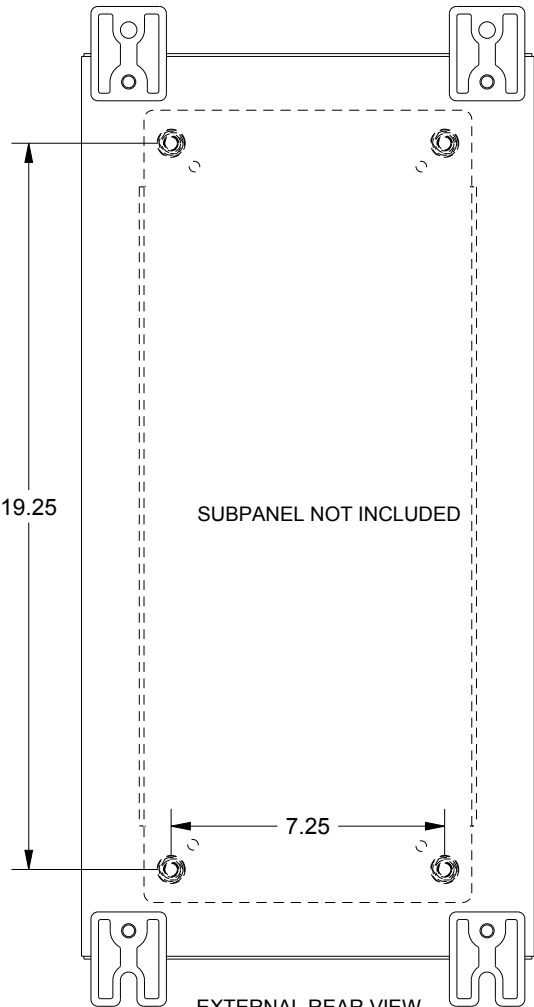

EXTERNAL REAR VIEW