

SAGINAW CONTROL & ENGINEERING

SCE-20EL1612SSST

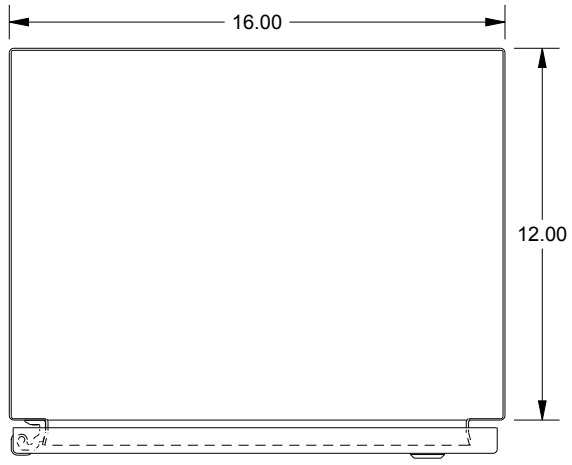

TOP VIEW

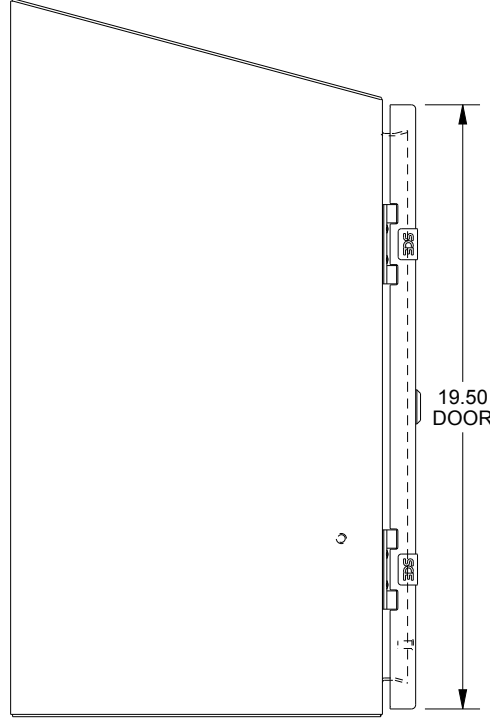

LEFT SIDE VIEW

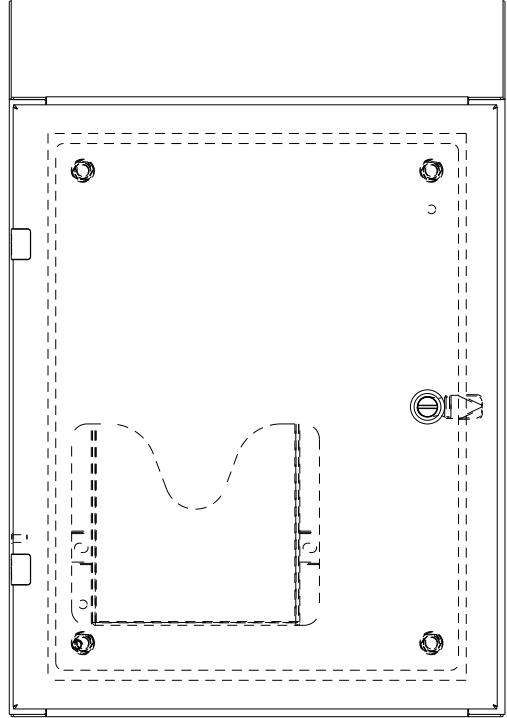

FRONT VIEW

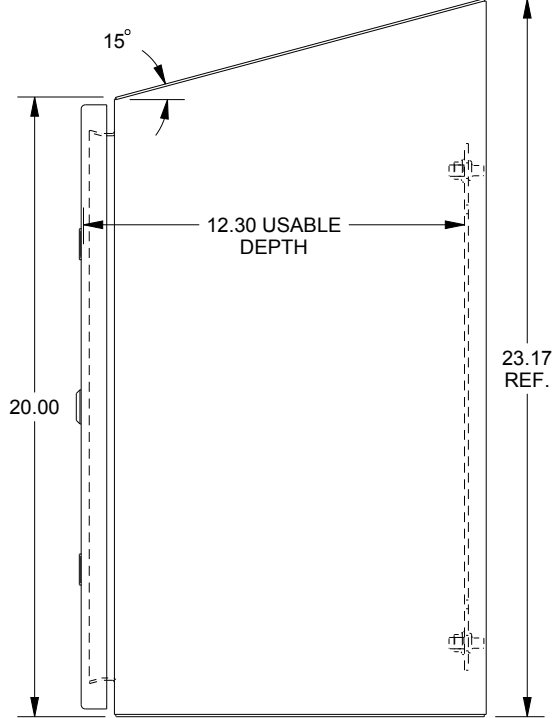

RIGHT SIDE VIEW

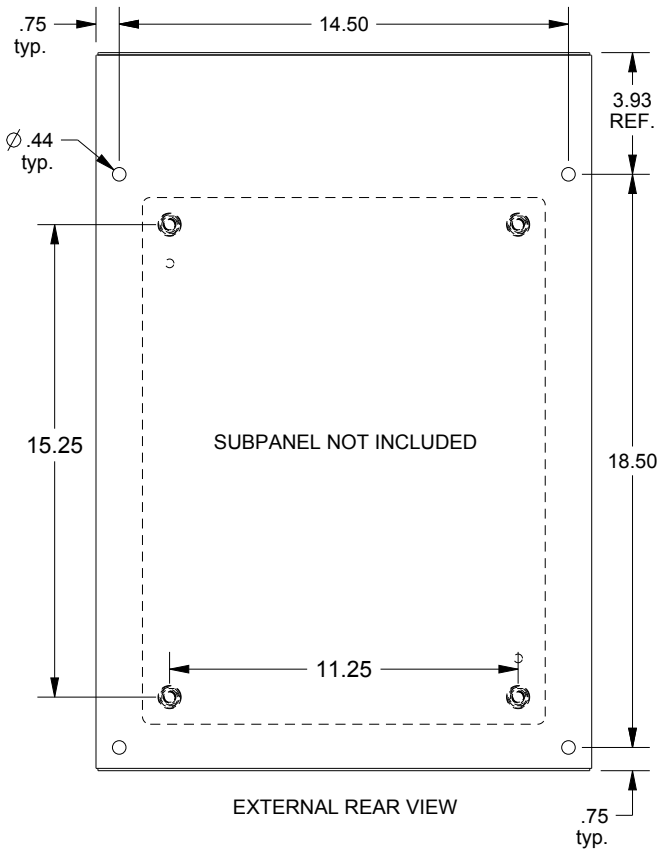

EXTERNAL REAR VIEW

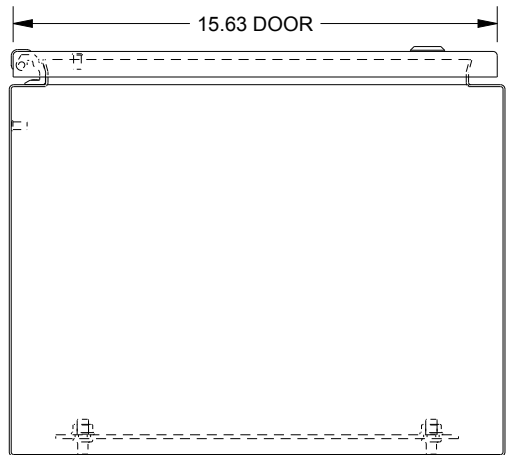

BOTTOM VIEW