

SAGINAW CONTROL & ENGINEERING

SCE-1PBXI

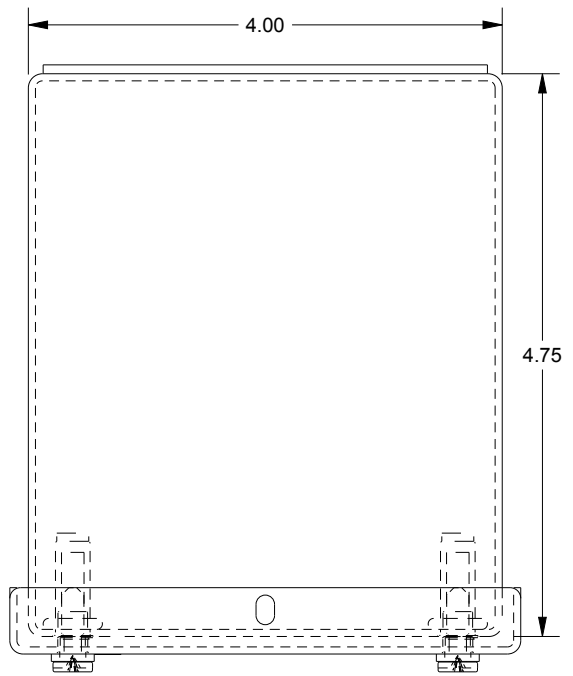

TOP VIEW

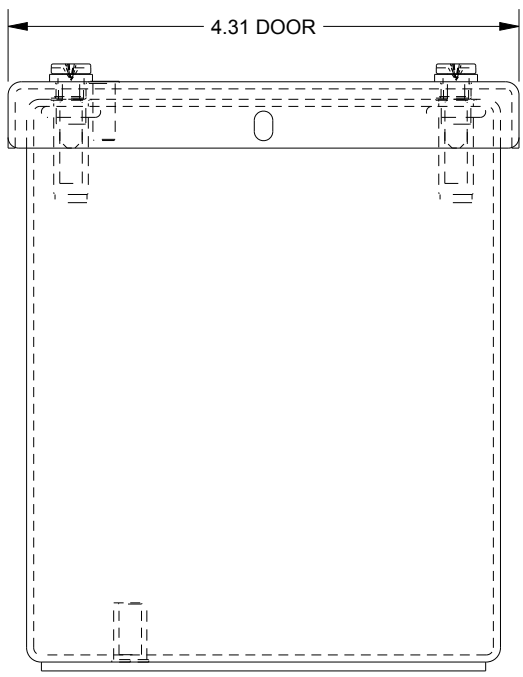

BOTTOM VIEW

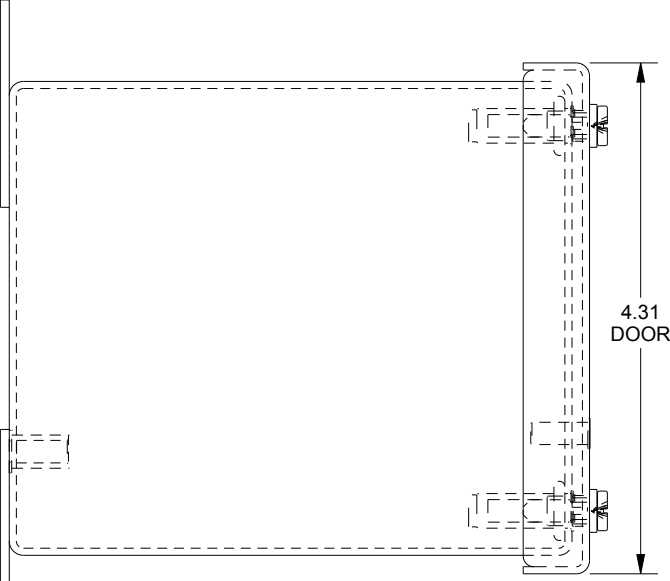

LEFT SIDE VIEW

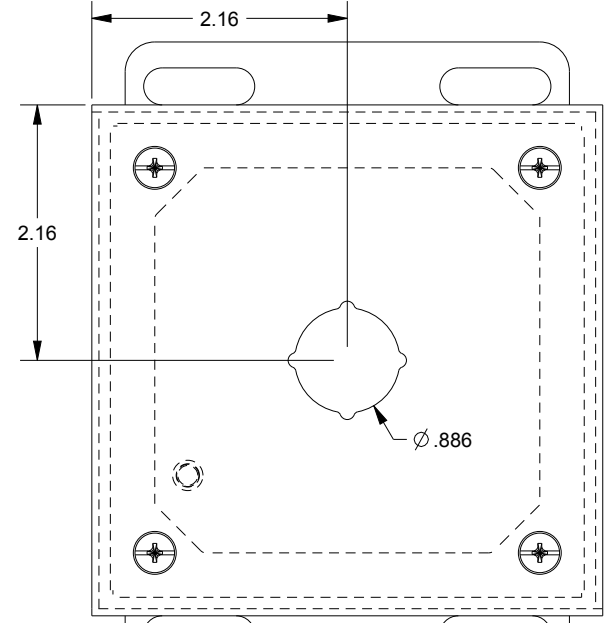

FRONT VIEW

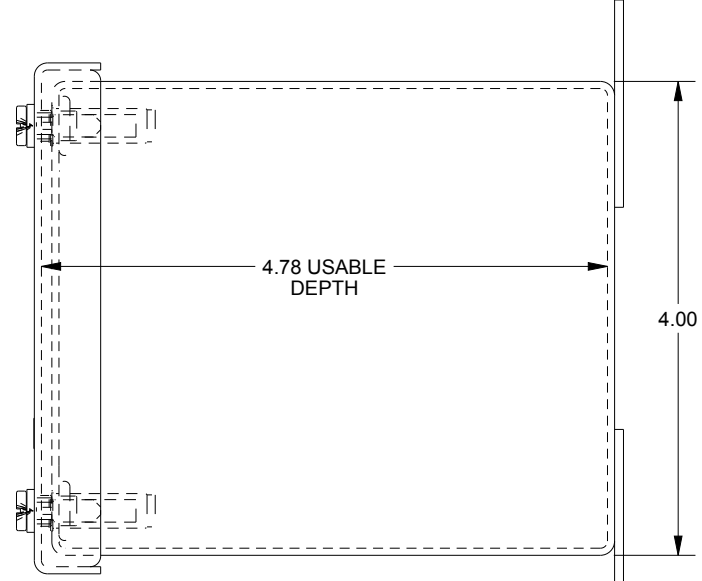

RIGHT SIDE VIEW

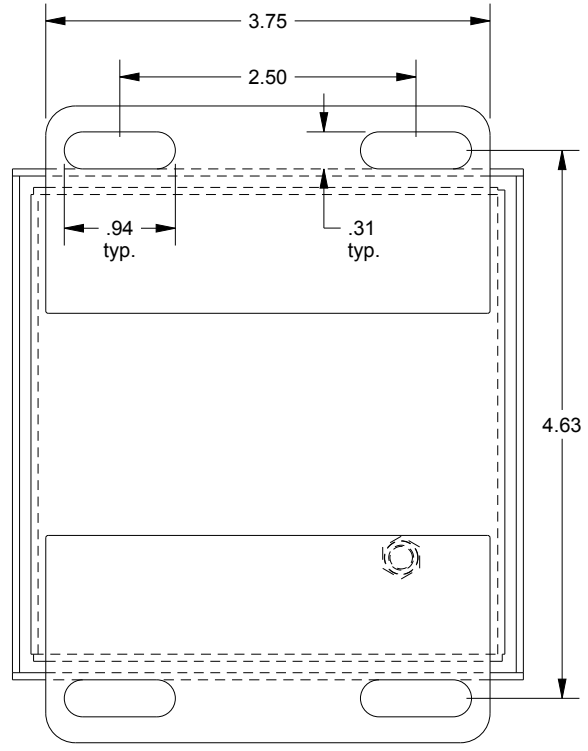

EXTERNAL REAR VIEW