

# SAGINAW CONTROL & ENGINEERING

SCE-16EL1206LP = SCE-09 GRAY  
 SCE-16EL1206LPLG = RAL 7035

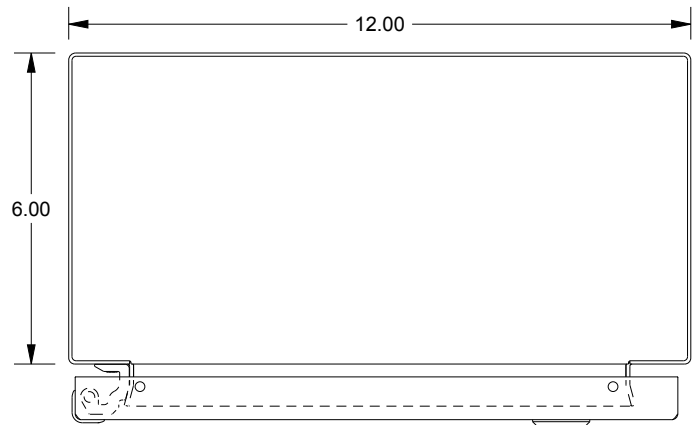

TOP VIEW

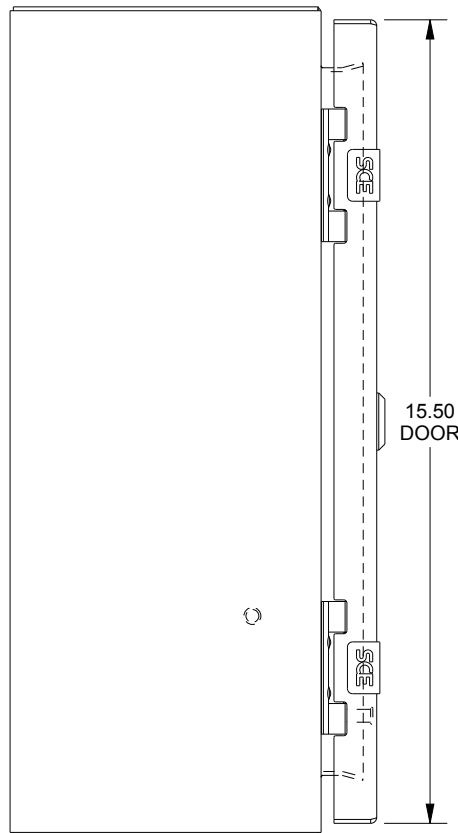

LEFT SIDE VIEW

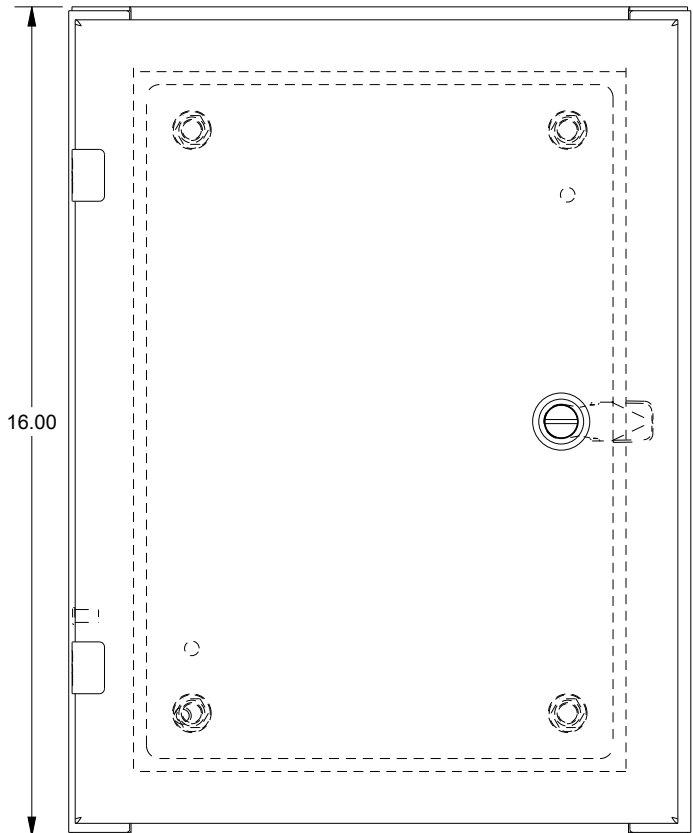

FRONT VIEW

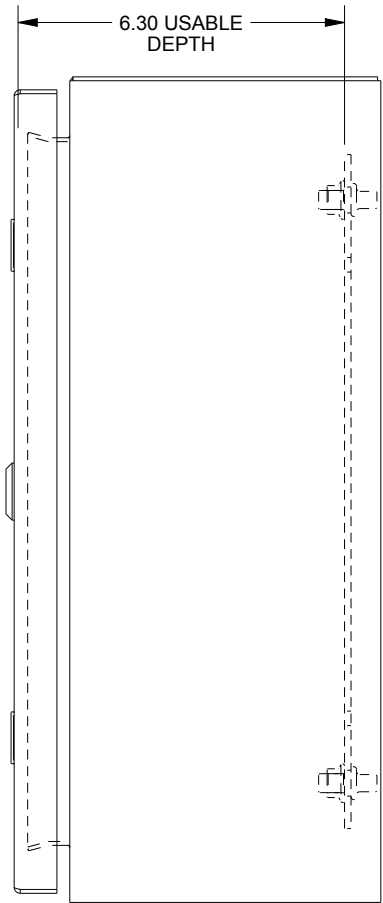

RIGHT SIDE VIEW

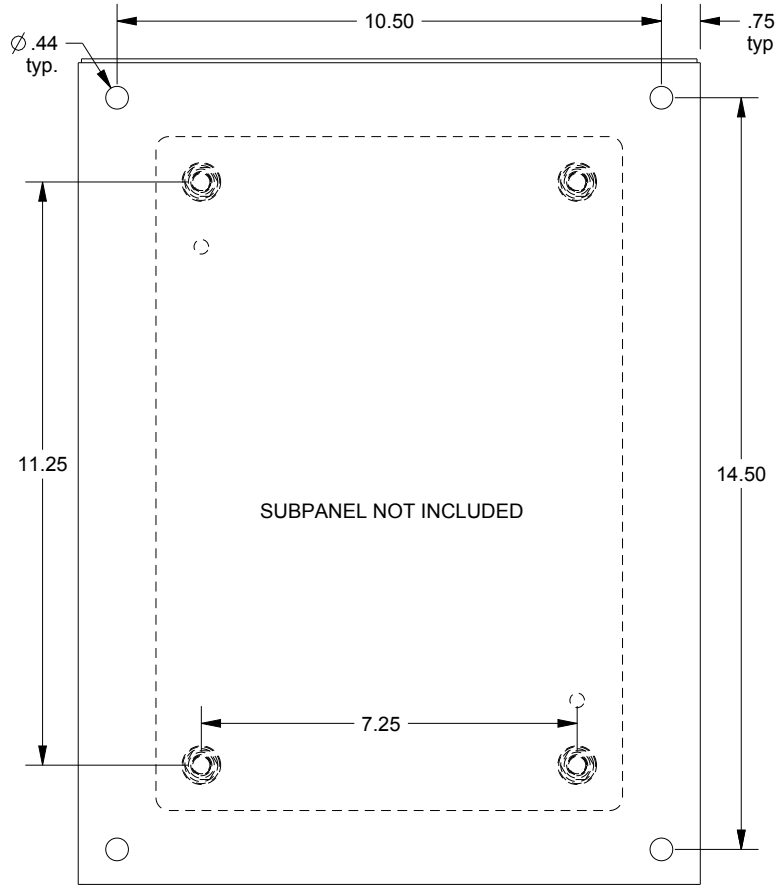

EXTERNAL REAR VIEW

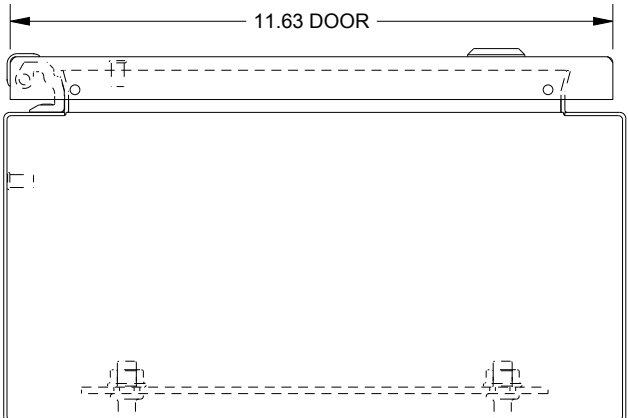

BOTTOM VIEW