

SAGINAW CONTROL & ENGINEERING

SCE-16C30ELJ

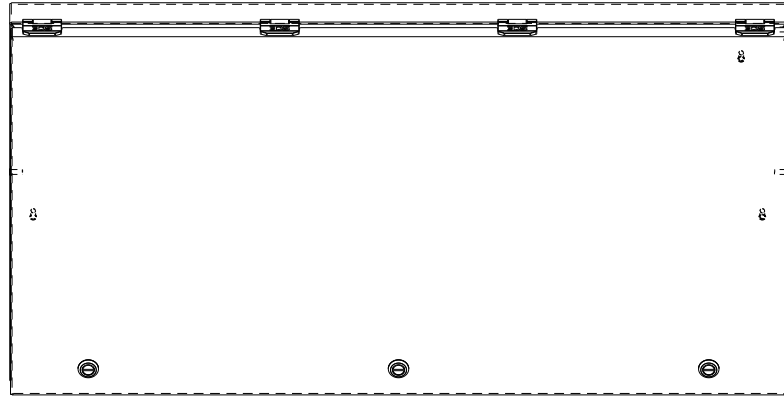

TOP VIEW

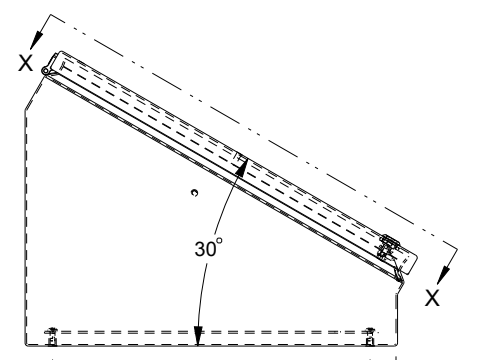

LEFT SIDE VIEW

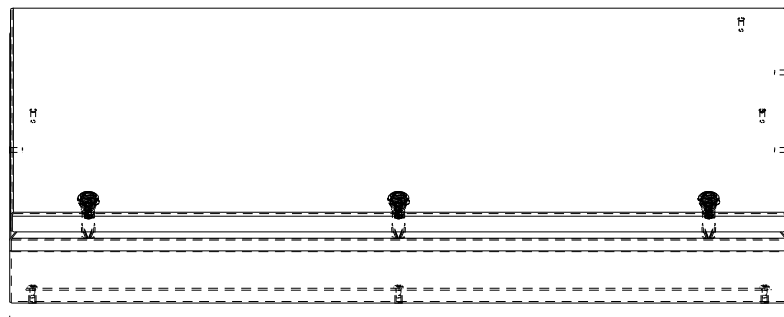

FRONT VIEW

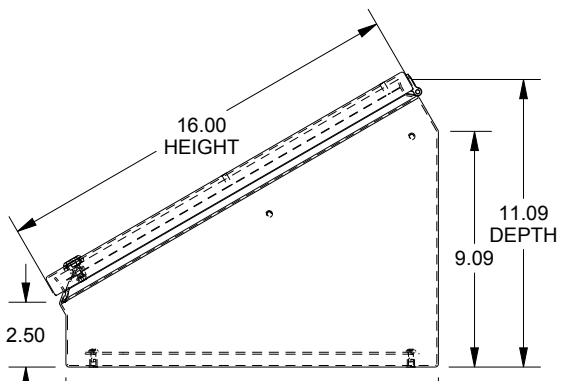

RIGHT SIDE VIEW

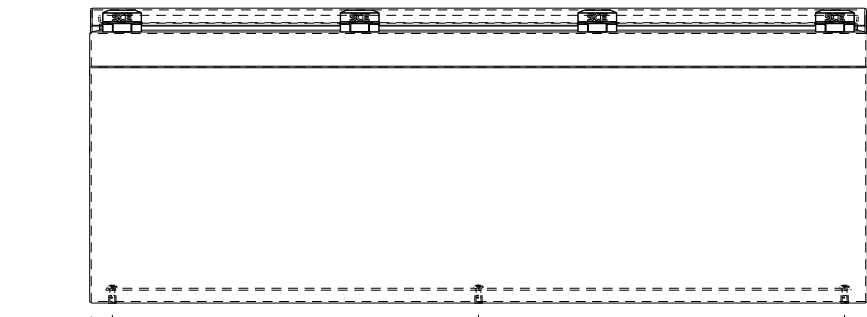

REAR VIEW

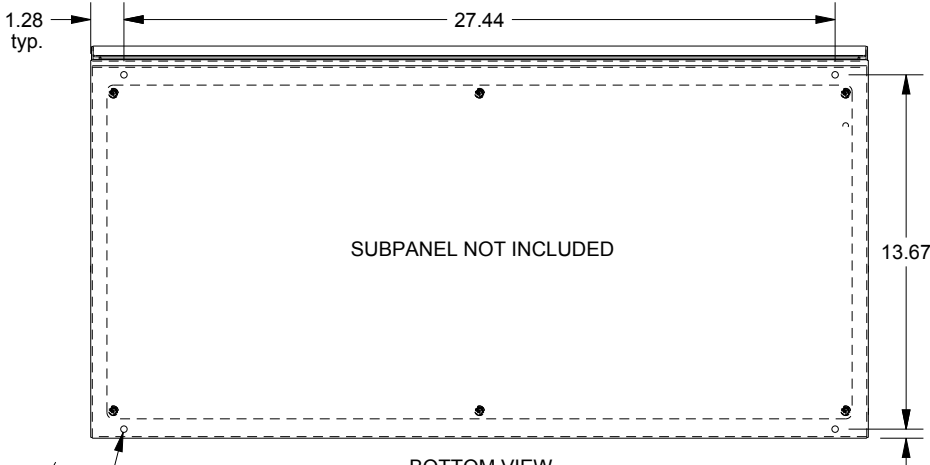

BOTTOM VIEW

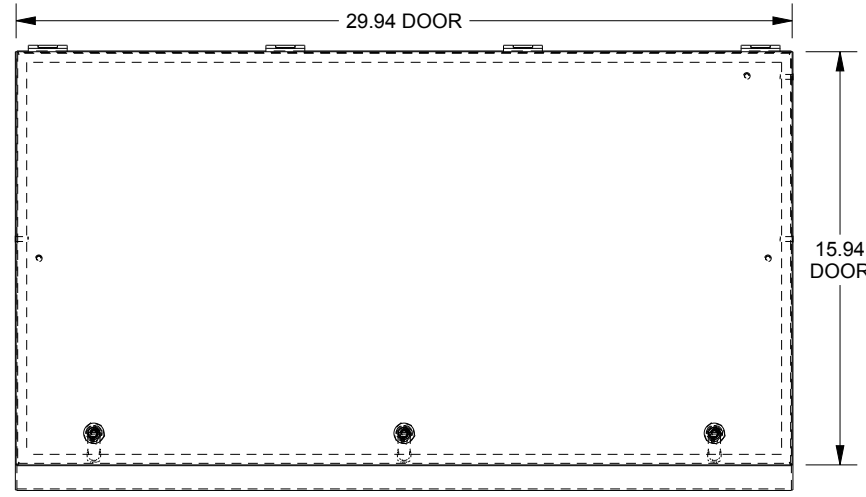

SECTION X-X