

SAGINAW CONTROL & ENGINEERING SCE-16C20ELJ

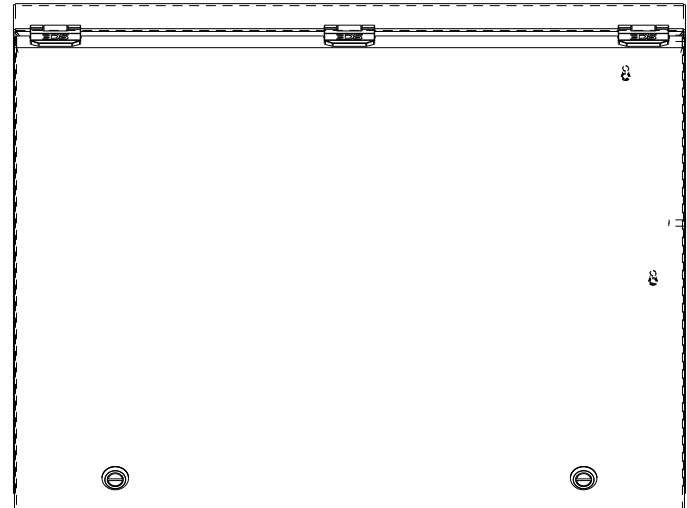

TOP VIEW

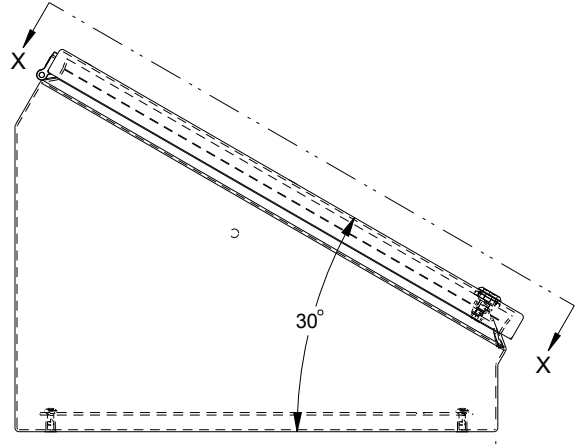

LEFT SIDE VIEW

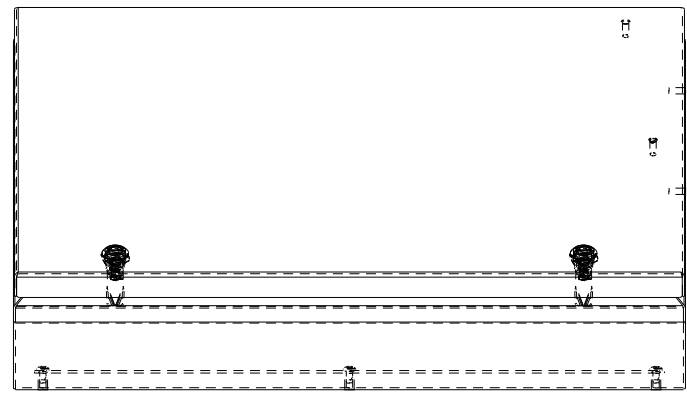

FRONT VIEW

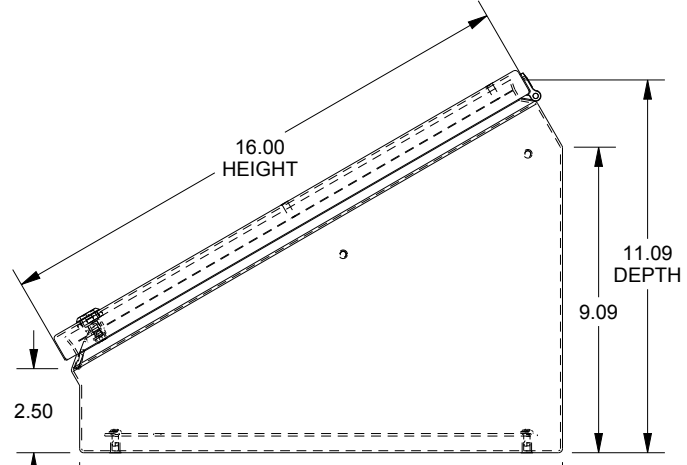

RIGHT SIDE VIEW

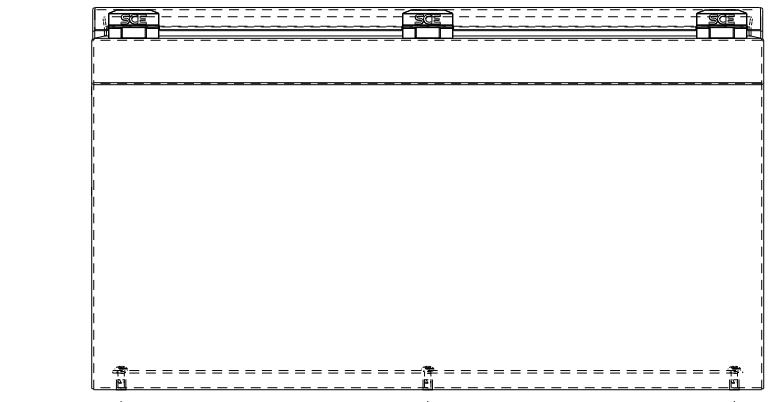

REAR VIEW

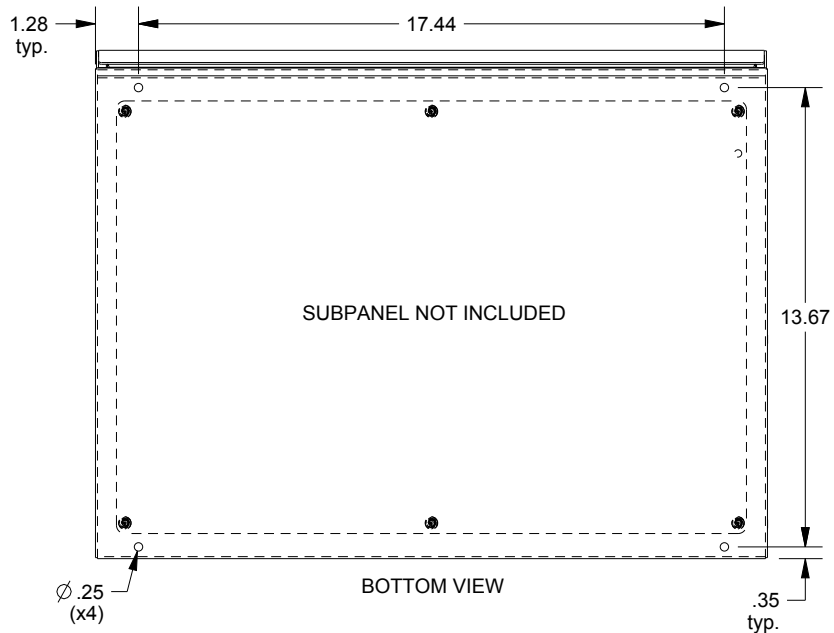

BOTTOM VIEW

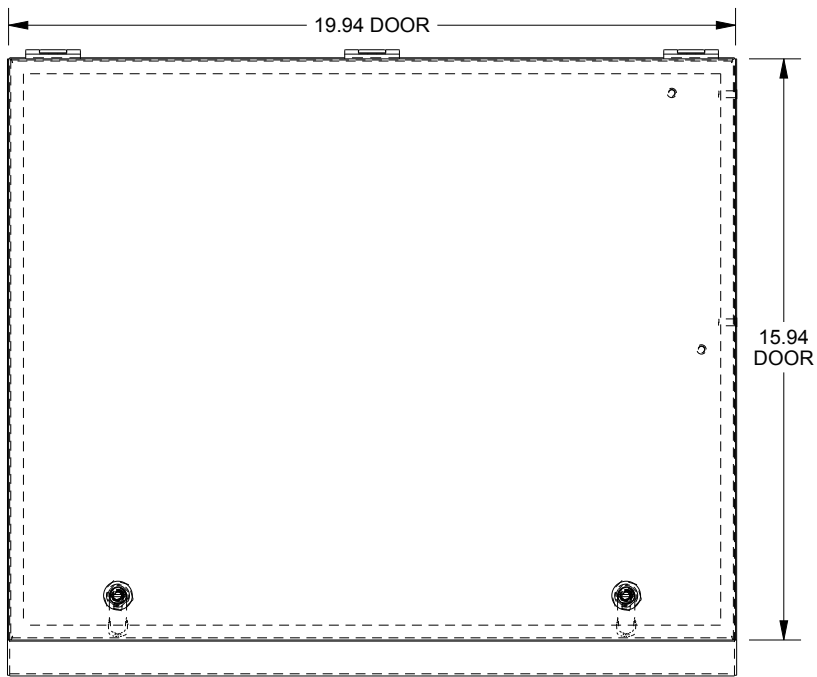

SECTION X-X