

SAGINAW CONTROL & ENGINEERING SCE-12PBA

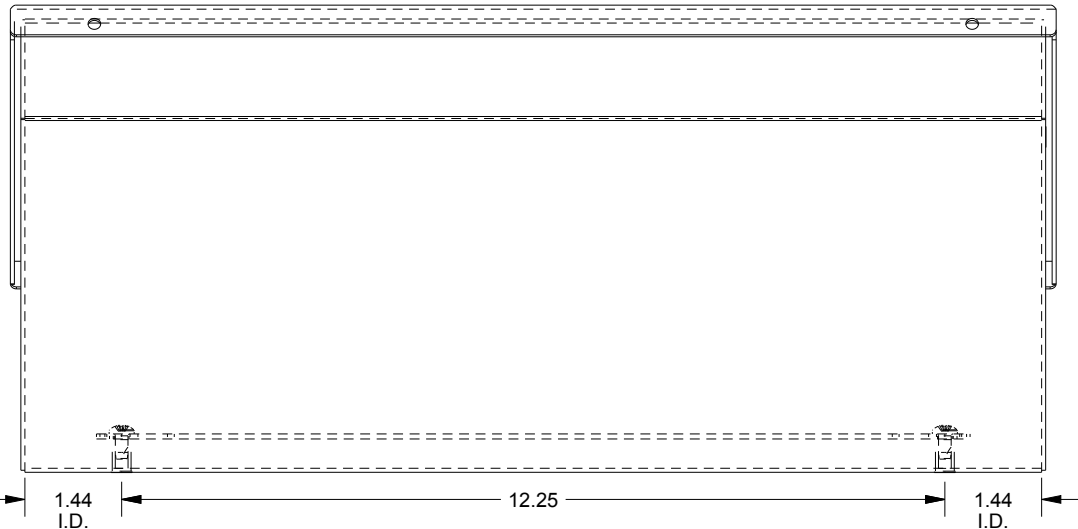

REAR VIEW

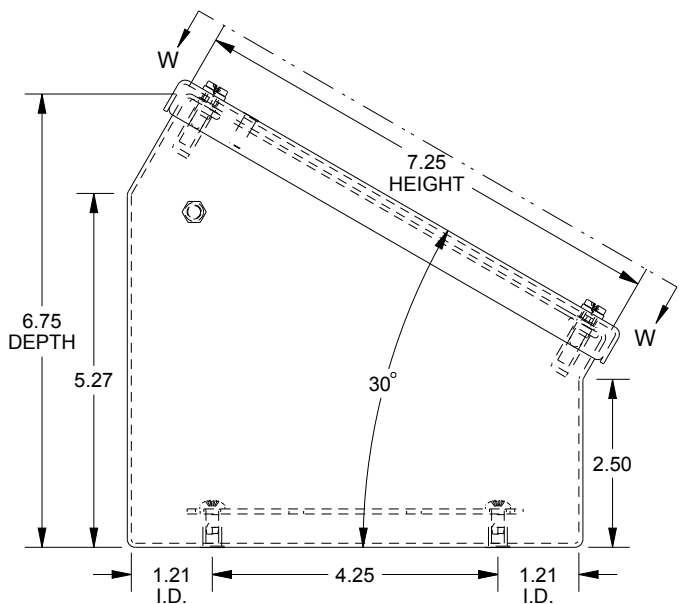

LEFT SIDE VIEW

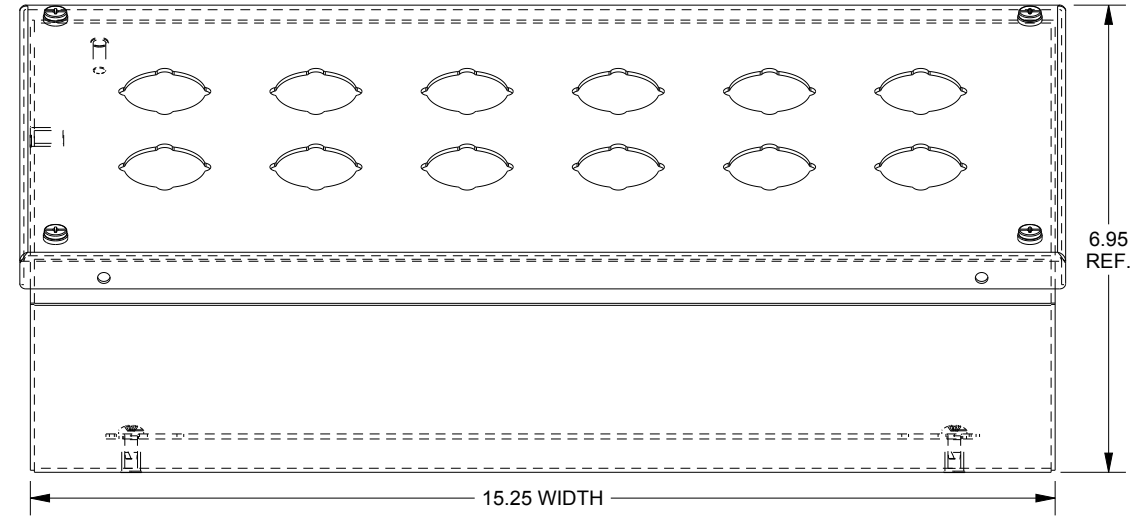

FRONT VIEW

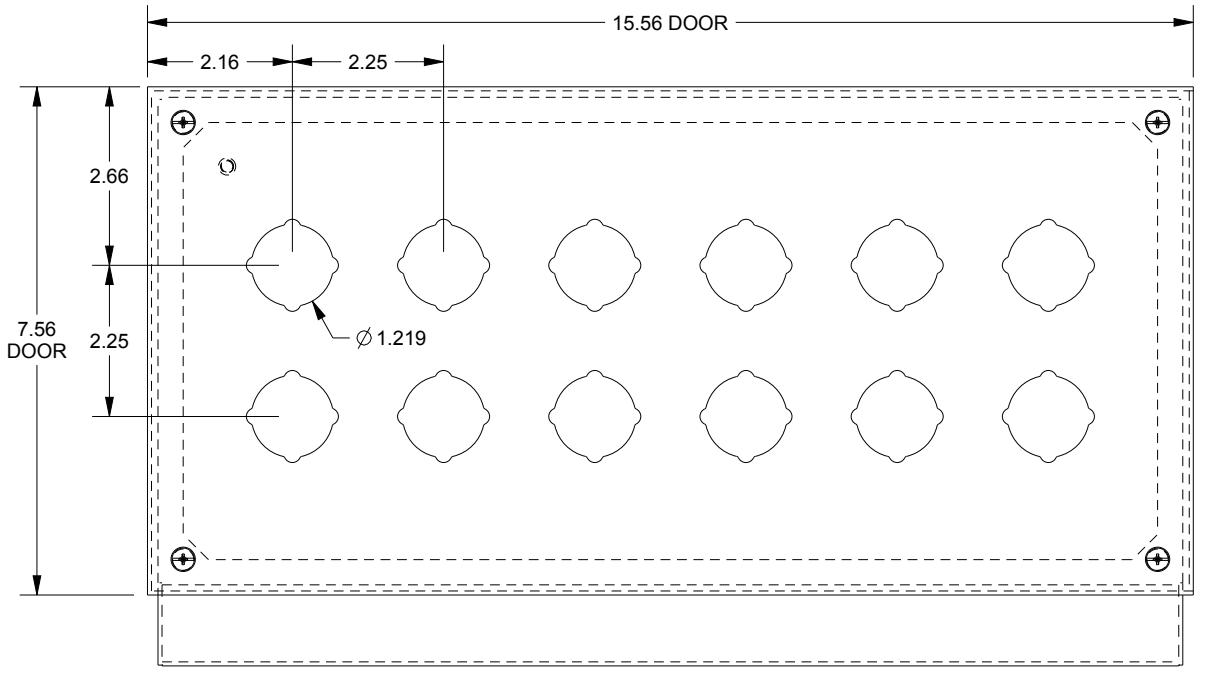

SECTION W-W

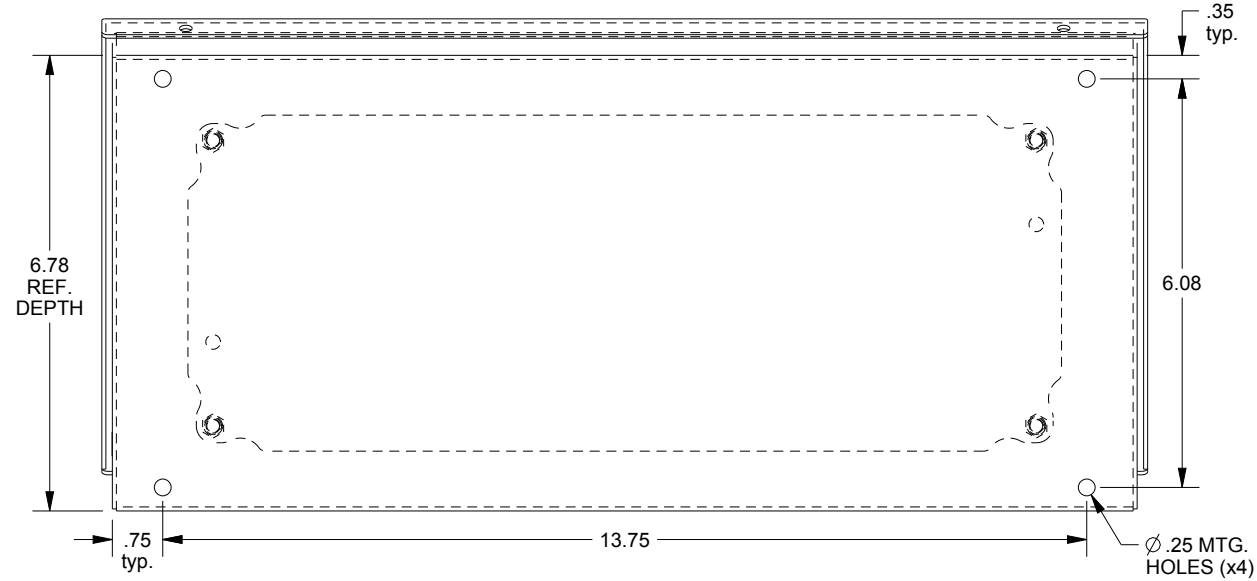

BOTTOM VIEW