



**SF40A PRINTER**  
**Instruction Manual**

**SF40A DRUCKER**  
**Bedienungsanleitung**

**Manuel d'instructions**  
**IMPRIMANTE SF40A**

**IMPRESORA SF40A**  
**Manual de instrucciones**

**STAMPANTE SF40A**  
**Manuale di istruzioni**





# CONTENTS

<b>Overview</b> .....	<b>1</b>
<b>1 Introduction</b> .....	<b>2</b>
1.1 Description.....	2
1.2 Features.....	2
1.3 Package Contents.....	2
<b>2 Startup Procedure</b> .....	<b>3</b>
2.1 Safety Measures.....	3
2.2 Power Supply.....	3
2.3 Printer setup.....	4
2.3.1 Printer setup using the accompanying software.....	4
2.3.2 Printer setup using printer only.....	7
2.4 Installing the Printer.....	8
2.4.1 Connecting the printer to the instrument.....	8
2.4.2 Switching the printer on.....	8
2.4.3 Inserting paper.....	8
<b>3 Keystroke Functions</b> .....	<b>9</b>
<b>4 Menu</b> .....	<b>10</b>
4.1 Menu tree structure.....	10
4.2 Printout example.....	11
4.3 Applications.....	12
<b>5 Printer Test</b> .....	<b>13</b>
<b>6 Maintenance</b> .....	<b>13</b>
6.1 Changing the Paper Roll.....	13
6.2 Replacing the Ribbon.....	13
6.3 Cleaning.....	14
6.4 Disposal.....	14
<b>7 Troubleshooting</b> .....	<b>15</b>

<b>8 Recommended Settings.....</b>	<b>17</b>
<b>9 Consumables and Spare Part.....</b>	<b>18</b>
<b>10 RS232C Interface.....</b>	<b>18</b>
<b>11 Technical Data.....</b>	<b>19</b>



## Overview

### Controls

### Connections

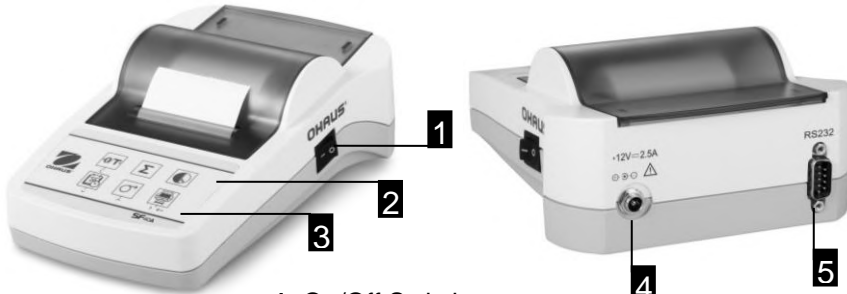

- 1 On/Off Switch
- 2 Pilot lamp – status indicator
- 3 Control panel
- 4 Power connection
- 5 Interface connector

### Control panel

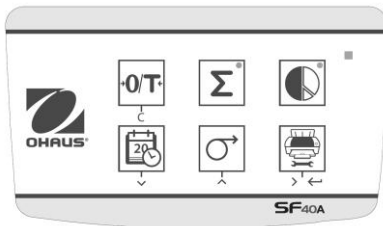

### Functions

Key	SF40A
	<ul style="list-style-type: none"> <li>Zeroing /Taring the balance</li> <li>Abort – Exit</li> </ul>
	<ul style="list-style-type: none"> <li>Printout of date and time</li> <li>Scroll down menu option</li> </ul>
	<ul style="list-style-type: none"> <li>Paper feed</li> <li>Scroll up menu option</li> </ul>
	<ul style="list-style-type: none"> <li>Printing of stable weight values</li> <li>Opening the menu - select next menu option</li> <li>Save settings</li> </ul>
	<ul style="list-style-type: none"> <li>Totaling application</li> </ul>
	<ul style="list-style-type: none"> <li>Statistics application</li> </ul>

# 1 Introduction

## 1.1 Description

The SF40A is an advanced dot matrix printer from OHAUS instruments. The printer has Statistics and Totalization functions. The SF40A also meets the requirements of modern quality assurance systems such as (GLP, GMP, ISO9001 etc.).

## 1.2 Features

- Supports all 13 languages present in Ohaus instruments.
- Statistics and Totalization functions.
- Zero / Tare function.
- Real-time clock function.
- The printout meets the requirements of modern quality assurance systems (GLP, GMP, ISO9001, etc.)
- Complies with the requirements of measurement traceability by precisely documenting the origin of data, as well as calibration procedures.
- Meets the requirement of archiving measurement results by providing a thermally stable and light resistant printout.
- Easy setup with the software provided with the printer.

## 1.3 Package Contents

- Printer
- Power Adapter
- Warranty Card
- RS232 Cable
- Instruction Manual
- Paper Roll
- Cable Adapter
- Paper Rotary Axis
- Power Cable\*

**Note:** \* AM/US version : 1 cable, EU/UK version : 2 cables.

## 2. Startup Procedure

### 2.1 Safety Measures

The Printer has been tested for the connections and intended purposes documented in these Operating Instructions. However, it is your responsibility to perform the necessary tests related to the methods and purposes of its intended use. Therefore, you should observe the following safety measures.



- The printer must be used indoors only, and never in hazardous areas.
- The electronics of the printer are protected against the ingress of splashing water and dust. However, since the printer housing is not watertight, the printer should not be used in the presence of liquids.
- Comply with cleaning instruction (see chapter 6.3), protect power plug against wet conditions.
- Never open the printer housing. If you have any problems with your printer, please contact your responsible OHAUS service.
- If the equipment is used in a manner not specified by the manufacturer, the protection provided by the equipment may be impaired.

### 2.2 Power Supply

Your printer is supplied with an AC adapter with a country-specific power cable. The power supply is suitable for all line voltages in the range: 100 – 240 VAC, 50 – 60 Hz (for exact specifications, see chapter 11).



#### Attention

- First, check the local line voltage is in the range 100 – 240 VAC, 50 - 60 Hz and whether the power plug fits your local power supply connection. **If this is not the case, on no account connect the printer or the AC adapter to the power supply**, but contact the responsible OHAUS dealer.
- **Only plug the adapter into a socket which is grounded.**

#### Important



- Before operating, check all cables for damage.
- Guide the cables so that they cannot become damaged or interfere with the weighing process.
- Make sure that the AC adapter cannot come into contact with liquids
- The power plug must always be accessible.



## 2.3 Printer Setup

The default setting of the printer is as below.

Header:	No Header	Baud rate:	9600
Date Format:	DD.MMM YYYY	Data bits:	8
Time Format:	24:MM:SS	Parity:	None
Char Set:	CP1252 Window Latin1	Stop bits:	1
Balance Feature:	Balance Feature Enable	Flow control:	Xon/Xoff
O/T Settings:	Perform Zero		

There are two ways to change the default setting:

- Use OHAUS software "ScaleMate".
- Operate on the printer only.

### 2.3.1 Printer setup using OHAUS software ScaleMate

- 1) Use the cable (Interface kit RS232-USB, PN 30304101) and accompanying cable adapter to connect the computer and the printer.
- 2) Connect the printer to the main power supply.
- 3) Use the main switch <I/O> to power on.
- 4) Install the OHAUS software ScaleMate (please contact your local OHAUS dealer for the software)
- 5) Run the software, click "Cancel", then choose "SF-40A Printer" and click "Enter".

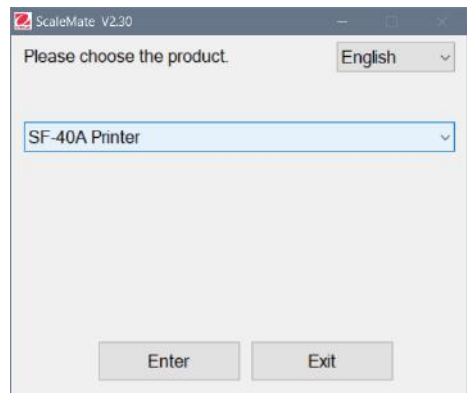
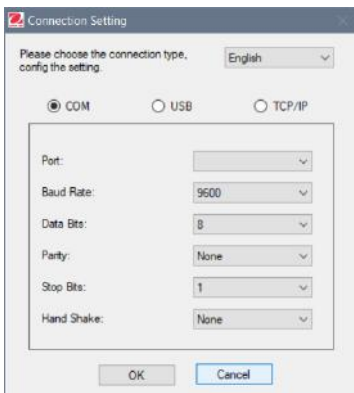

- 6) Configure the COM port setting of the computer, then click the “Connect” button. The following window will appear if connection is successful, click OK to continue.

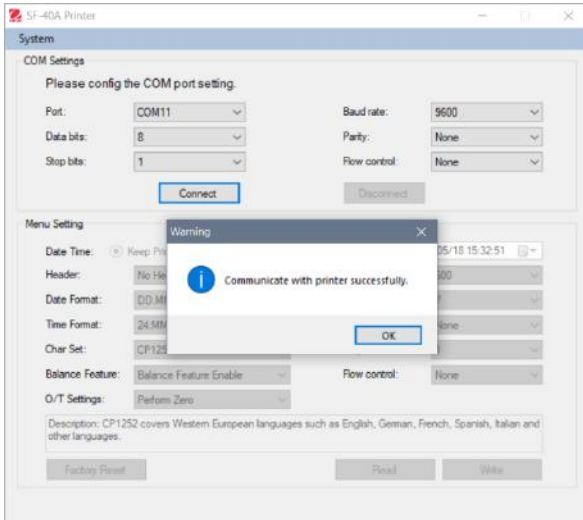

- 7) The printer Menu setting is now activated and all the settings can be changed.

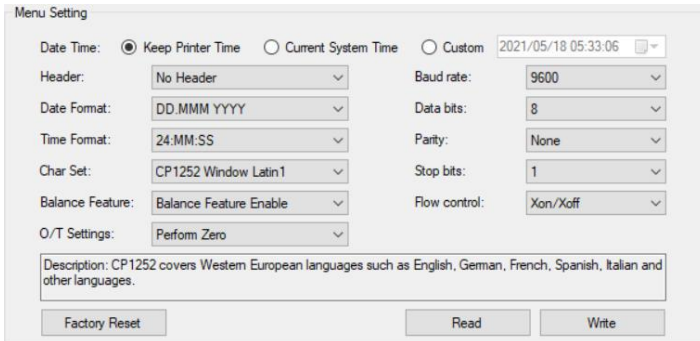

- a. **Date Time:** Set the date and time for the printer
  - Keep Printer Time: keep the existing date and time in the printer
  - Current System Time: Get the date and time from your computer
  - Custom: Set the date and time manually

**Note:** The date and time of the balance has priority when:

- The balance/scale has built-in data/time.

- The Balance Feature in SF40A is enabled.
- b. **Header:** Set the header of the printing content
  - No header: No header for printing content
  - Date/Time: Header with date and time
  - Date/Time/Balance: Header with date, time and the serial number of the balance/scale.
- c. **Date Format:** Set date format
- d. **Time Format:** Set Time Format
- e. **Char Set:** Set the Code page for different languages
  - CP 1252 Window Latin1: Covers Western European languages such as English, German, French, Spanish and Italian.
  - CP 1251 Window Cyrillic: Covers languages that use the Cyrillic alphabet such as Russian, Bulgarian and Serbian Cyrillic.
  - CP437 MS-DOS Latin US: Covers Western European languages such as English, German, French, Spanish and Italian.
  - CP852 MS-DOS Latin2: Covers Central European languages that use Latin script such as Polish Bosnian, Czech, Hungarian, Croatian, Romanian, Serbian and Slovak.
  - CP860 MS-DOS Portuguese: Covers Portuguese language

**Note:** SF40A supports Chinese, Korean and Japanese no matter what Character code is.

- f. **Balance Feature :**
  - 1) Enable/Disable a function of the printer: 0/T, Statistics, Totalization
  - 2) Printer connection status: LED light will either blink or stay lit.
    - Balance Feature Enabled: 0/T, Statistics and Totalization functions of the printer are enabled. The printer connection status LED light will blink if the connection with balance is lost.
    - Balance Feature Disable: 0/T, Statistics, Totalization functions of the printer are disabled. The printer connection status LED will be lit even if the connection with balance is lost.

- g. **0/T Setting:** Set up the function of the button 0/T
  - Perform Zero: Perform Zero function when pressing the button.
  - Perform Tare: Perform Tare function when pressing the button.
- h. **Baud rate, Data bits, Parity, Stop bits, Flow control:** Set the parameters of RS232 setting.

The settings should be the same as the instrument to be connected.  
For the instrument RS232 settings, please see the instrument manual.

Factory Reset	Reset the printer to factory default setting. <ul style="list-style-type: none"> <li>- Baud rate: 9600</li> <li>- Data bits: 8</li> <li>- Parity: None</li> <li>- Stop bits: 1</li> <li>- Flow control: Xon/Xoff</li> </ul>
Read	Get the current setting from the printer.
Write	Save the setting to the printer.

8) Click "Write" button to save the setting to the printer.

### 2.3.2 Printer setup using printer only

- 1) Connect the printer to the main power supply.
- 2) Use the main switch <I/O> to power on.

3) Press and hold the «  » button to enter the menu list, the printer will print

“-----Menu-----”.

Press «  » to choose which item to change.

Press «  » to change the parameter.



Press and hold «  » to save and exit.

Press «  » to exit without saving

The printer will print the content to show the result of every operation.

For total menu structure, please see chapter 4.

To check the version number of SF40A, use the main switch <I/O> to

power on while pressing and holding the «  » button. When the printer starts printing, release the «  » button.

## 2.4 Installing the printer

### 2.4.1 Connecting the printer to the instrument

Before connecting, make sure the instrument and printer have the same RS232 parameter setting. For instrument Baud rate settings, please see the related manual.

- Attach the interconnecting cable to the printer interface of the instrument and to the printer.
- Switch the instrument on.

### 2.4.2 Switching the printer on







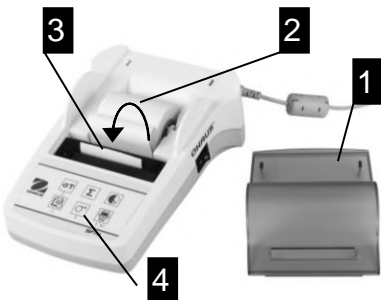











- Connect the printer to the mains power.
- Use the main switch <I/O> to power on.
- RS232 interface only: The pilot lamp will flash until an instrument is connected. If the lamp continues to flash see chapter 7.

### 2.4.3 Inserting Paper



- Remove paper cover (pull on the back) (1).
- Insert the paper rotary axis through the core of the paper roll (2).
- Feed paper through the slot in the printing unit in the direction of the arrow (3).
- Press and hold until enough paper has been fed (4).
- Replace the paper cover (1).

### 3 Keystroke Functions

	 Press briefly	 Press and hold
<div style="display: flex; align-items: center;"> <div style="writing-mode: vertical-rl; transform: rotate(180deg); background-color: #e0e0e0; padding: 5px; font-weight: bold; margin-right: 10px;">Operational Level</div> <div style="flex: 1;"> <div style="display: flex; align-items: center; margin-bottom: 10px;">  <div style="margin-left: 10px;">Zero or Tare the balance</div> </div> <div style="display: flex; align-items: center; margin-bottom: 10px;">  <div style="margin-left: 10px;">print Date and Time</div> </div> <div style="display: flex; align-items: center; margin-bottom: 10px;">  <div style="margin-left: 10px;">one line feed</div> </div> <div style="display: flex; align-items: center;">  <div style="margin-left: 10px;">print</div> </div> </div> </div>	<div style="display: flex; align-items: center; margin-bottom: 10px;">  <div style="margin-left: 10px;">continuous feed (until release)</div> </div> <div style="display: flex; align-items: center;">  <div style="margin-left: 10px;">open menu</div> </div>	
<div style="display: flex; align-items: center;"> <div style="writing-mode: vertical-rl; transform: rotate(180deg); background-color: #e0e0e0; padding: 5px; font-weight: bold; margin-right: 10px;">Menu Level</div> <div style="flex: 1; border: 1px dashed black; padding: 10px;"> <div style="display: flex; align-items: center; margin-bottom: 5px;">     </div> <div style="display: flex; justify-content: space-around; margin-top: 5px;"> <span>exit</span> <span>down</span> <span>up</span> <span>next</span> </div> </div> </div>	<div style="display: flex; align-items: center;">  <div style="margin-left: 10px;">store</div> </div>	
<div style="display: flex; align-items: center;"> <div style="writing-mode: vertical-rl; transform: rotate(180deg); background-color: #e0e0e0; padding: 5px; font-weight: bold; margin-right: 10px;">Function Level</div> <div style="flex: 1;"> <div style="display: flex; align-items: center; margin-bottom: 10px;">  <div style="margin-left: 10px;">Start totaling application</div> </div> <div style="display: flex; align-items: center;">  <div style="margin-left: 10px;">Start statistics application</div> </div> </div> </div>	<div style="display: flex; align-items: center; margin-bottom: 10px;">  <div style="margin-left: 10px;">Conclude totaling application</div> </div> <div style="display: flex; align-items: center;">  <div style="margin-left: 10px;">Conclude statistics application</div> </div>	

# 4 Menu

## 4.1 Menu tree structure

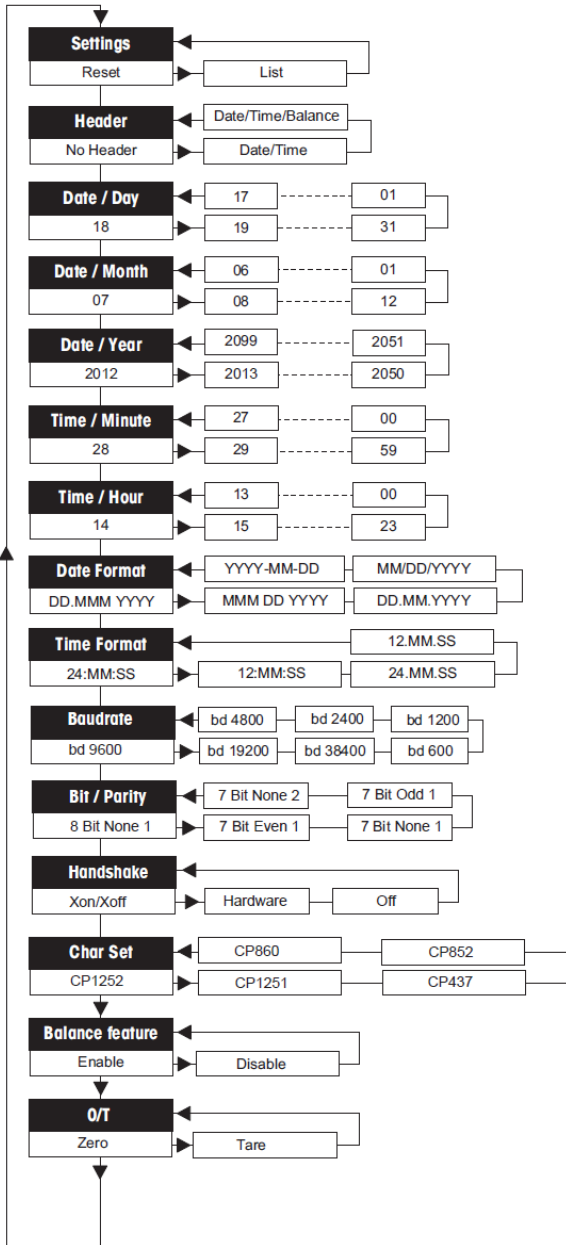























## 4.2 Printout example

```
-----MENU-----  
Settings:  
  * List  
  
Header:  
  * No Header  
  
Date Day:  
  31  
  
Date Month:  
  07  
  
Date Year:  
  2012  
  
Time Minute:  
  00  
  
Time Hour:  
  18  
  
Date Format:  
  * YYYY-MM-DD  
  
Time Format:  
  * 24:MM:SS  
  
Baudrate:  
  * 9600  
  
Bit/Parity:  
  * 8 Bit None 1  
  
Handshake:  
  * Xon/Xoff  
  
Char Set:  
  * CP1252 Windows Latin 1  
  
Balance Feature:  
  * Enable  
  
->0/T<- Setting:  
  * Zero
```

\* Factory settings



### 4.3 Applications

 Press briefly		 Press and hold	
<b>Statistics Application</b>		<b>Totaling Application</b>	
 	→ Start “Statistics application” (LED on)	 	→ Start “Totaling application” (LED on)
 	→ Add a new sample and press «  ».	 	→ Add a new sample and press «  ».
 	→ If needed print subtotal press «  »	 	→ If needed print subtotal press «  »
 	→ Print and end “Statistic application” (LED off).	 	→ Print and end “Totaling application” (LED off).

#### Important notes



Unit change during the application is not permitted.

- 1) Maximum 999 samples can be stored in each of above applications (statistics and totaling).
- 2) Minimum sample weight should be larger than 1d.
- 3) During application, the change of sample weight on the weighing pan should be more than 100d, otherwise the printer will not register the sample change.
- 4) The report for statistics applications includes: number of samples, average value, standard deviation, min, max, min-max differential and total weight.

## 5 Printer Test

The printer is equipped with a self-test that automatically prints out the character set of the printer (standard IBM/DOS).

### Starting the test

-  Press the «» key and power on the printer. The printer prints out the current settings.

### Terminating the test

- Power off the printer.

## 6 Maintenance

Under normal conditions the printer requires practically no maintenance. The OHAUS service department is available if servicing is required. Please ask your responsible OHAUS dealer for details.

### 6.1 Changing the Paper Roll

Insertion of a new roll of paper is described in chapter 2.4. Please see chapter 9 (Consumables) for paper roll order number.

**Note:** You may obtain the paper rotary axis from the old paper roll.

### 6.2 Replacing the Ribbon



- Remove the paper cover (1)
- Pull paper out of printing unit (2)



- To remove the ribbon cartridge, press in direction of arrow (3).
- Insert the new ribbon, and if necessary, take up slack with tensioning wheel (4). See chapter 9 (Consumables) for the ribbon cartridge order number.
- Insertion of a new roll of paper is described in chapter 2.4.

### 6.3 Cleaning

Since the printer housing is made of top grade materials, all commercially available mild cleaning agents may be used (see safety precautions in chapter 2.1).

### 6.4 Disposal

#### Disposal

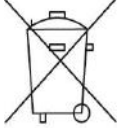

In conformance with the European Directive 2002/96/EC on Waste Electrical and Electronic Equipment (WEEE) this device may not be disposed of in domestic waste.

This also applies to countries outside the EU, per their specific requirements.

Please dispose of this product in accordance with local regulations at the collecting point specified for electrical and electronic equipment. If you have any questions, please contact the responsible authority or the distributor from which you purchased this device.

Should this device be passed on to other parties (for private or professional use), the content of this regulation must also be related.

Disposal instructions in Europe are available online at [europe.ohaus.com/europe/en/home/support/weee.aspx](http://europe.ohaus.com/europe/en/home/support/weee.aspx).

Thank you for your contribution to environmental protection.

## 7 Troubleshooting

Problem / Message	Possible cause	Correction
Printout unreadable	<ul style="list-style-type: none"> <li>Ribbon worn or entangled.</li> <li>Service life of printing unit at an end.</li> </ul>	<ul style="list-style-type: none"> <li>Change ribbon cartridge or tense the ribbon properly.</li> <li>Please contact OHAUS service.</li> </ul>
Pilot lamp does not light	<ul style="list-style-type: none"> <li>No power.</li> <li>Power supply fault.</li> </ul>	<ul style="list-style-type: none"> <li>Switch printer on.</li> <li>Please contact OHAUS service.</li> </ul>
Pilot lamp flashes	<ul style="list-style-type: none"> <li>No connection printer device.</li> <li>Printer did not find the settings of the connected instrument.</li> </ul>	<ul style="list-style-type: none"> <li>Make sure that the printer and the instrument is connected.</li> <li>Switch the printer off/on.</li> <li>Alternatively change the settings of the printer or the connected instrument. (see chapter 2.4)</li> </ul>
-----Timeout-----	<ul style="list-style-type: none"> <li>Data transfer has not completed in the last 45 s.</li> </ul>	<ul style="list-style-type: none"> <li>Move balance to more stable location.</li> <li>Check the balance.</li> </ul>
-----Over Load-----	<ul style="list-style-type: none"> <li>Balance in overload range.</li> <li>Zeroing out of the zero range.</li> </ul>	<ul style="list-style-type: none"> <li>Check the sample weight.</li> <li>Change the zero range of the balance.</li> <li>Change the setting of the printer from zero to tare.</li> </ul>
-----Under Load-----	<ul style="list-style-type: none"> <li>Balance in underload range. Weighing pan is not in position.</li> </ul>	<ul style="list-style-type: none"> <li>Check the balance.</li> </ul>
--Transmission Error--	<ul style="list-style-type: none"> <li>Instrument does not understand printer instruction.</li> </ul>	<ul style="list-style-type: none"> <li>Check interface parameter settings on printer and instrument.</li> </ul>

Problem / Message	Possible cause	Correction
-----Not Executable-----	<ul style="list-style-type: none"> <li>Instrument cannot execute printer instruction.</li> </ul>	<ul style="list-style-type: none"> <li>Check the balance.</li> </ul>
---Date/Time Not Set--- -----Memory Error-----	<ul style="list-style-type: none"> <li>Printer error messages.</li> </ul>	<ul style="list-style-type: none"> <li>Check the instrument.</li> <li>Reset the printer.</li> <li>Set date/time</li> <li>Back-up battery depleted Please contact OHAUS service.</li> </ul>
----- Memory full-----	<ul style="list-style-type: none"> <li>Statistics or Totaling Memory is full. (more than 999 samples)</li> </ul>	<ul style="list-style-type: none"> <li>Start a new Statistics or Totaling application.</li> </ul>
--Load/Unload Weight--	<ul style="list-style-type: none"> <li>No sample or the same sample is on the weighing pan.</li> </ul>	<ul style="list-style-type: none"> <li>Put a new sample or remove it and put it again on the pan.</li> </ul>
Unit change not allowed!	<ul style="list-style-type: none"> <li>Changed unit during Statistics or Totaling application.</li> </ul>	<ul style="list-style-type: none"> <li>Reset the balance.</li> <li>Change the unit back to the first one.</li> </ul>
-----Out of range-----	<ul style="list-style-type: none"> <li>Sample weight is out of range</li> </ul>	<ul style="list-style-type: none"> <li>Sample weight must be in the range of 70% - 130% of the current average value.</li> </ul>

## 8 Recommended Settings

Connected Device	Device Settings	Printer Settings
DV, AV, PA, AR, AX, PX SP, TA, NV, NVL, NVT, MB35/45, MB23/25, MB90/120 (T31P, T51P, T71P, T32XW, T32WE, T51 XW, T71XW, CKW)*	Printer Mode Baud rate: 9600 Bit / Parity: 8 bit None 1 Handshake: Xon/Xoff	Factory Settings
EX	Printer Mode Baud rate: 9600 Bit / Parity: 8 bit None 1 Handshake: Xon/Xoff	Factory Settings
Russian	Printer Mode Baud rate: 9600 Bit / Parity: 8 bit None 1 Handshake: Xon/Xoff Language: ANSI/WIN Russian	CP1251 Windows Cyrillic
Polish	Printer Mode Baud rate: 9600 Bit / Parity: 8 bit None 1 Handshake: Xon/Xoff Language: ANSI/WIN Polish	CP852 MS-DOS Latin2
Czech	Printer Mode Baud rate: 9600 Bit / Parity: 8 bit None 1 Handshake: Xon/Xoff Language: ANSI/WIN Czech	CP852 MS-DOS Latin2
Hungarian	Printer Mode Baud rate: 9600 Bit / Parity: 8 bit None 1 Handshake: Xon/Xoff Language: ANSI/WIN Hungarian	CP852 MS-DOS Latin2
Portuguese	Printer Mode Baud rate: 9600 Bit / Parity: 8 bit None 1 Handshake: Xon/Xoff Language: ANSI/WIN Portuguese	CP860 MS-DOS Portuguese
English, French, German, Italy, Spanish, Chinese, Japanese, Korean	Printer Mode Baud rate: 9600 Bit / Parity: 8 bit None 1 Handshake: Xon/Xoff	Factory Settings

**Note:** \* The Statistic and Totalization functions of the printer are supported in the following models: DV, EX, AV, PA, NV, MB23/25, AX and PX.  
Only printing function is supported in all other models.

### 9 Consumables & Spare Parts

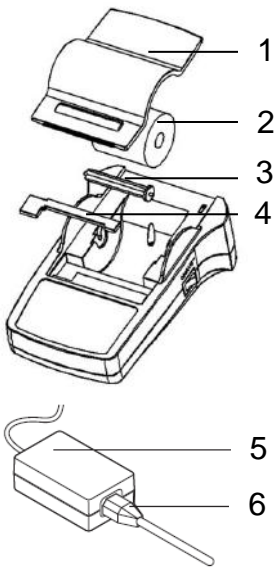

Pos.	Item	Part Number	Delivery Quantity
1	Paper Cover	30047939	1 pcs
2	Paper roll	12120799	1 pcs
3	Paper Rotary axis	30063920	1 pcs
4	Ribbon cartridge, black	30529322	1 pcs
5	AC/DC adapter (without power cable) 100 - 240 VAC, 50 - 60 Hz, 12 VDC 2.5 A	30529321	1 pcs
6	Power cable CH Power cable EU Power cable US Power cable IT Power cable GB Power cable AU Power cable BR Power cable JP	30064089 12120761 12120762 30064200 12120312 12120313 83033772 12122638	1 pcs 1 pcs 1 pcs 1 pcs 1 pcs 1 pcs 1 pcs 1 pcs
-	RS9 M/F Cable, 1.5 m	30529323	1 pcs

### 10 RS232C Interface

The SF40A printer is equipped with an RS232C interface to connect OHAUS instruments.

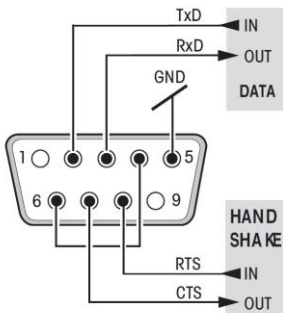

- 9-pin male connector
- Matching to other devices (transmission parameters) see chapter 8.

## 11 Technical Data

Power supply	AC/DC adapter: 12 VDC, 2.5 A Primary: 100 – 240 VAC, -50 -60 Hz Voltage fluctuations: up to $\pm 10\%$ of the nominal voltage Secondary: 12 VDC, 2.5 A (with electronic overload protection)
Cable to AC/DC adapter	3-core, with country-specific plug
Power line voltage	12 VDC
Power consumption	Max. 2.5 A
Altitude	up to 2000 m
Ambient temperature	0 °C – 40 °C
Relative humidity	Max. 80% at 31 °C, decreasing linearly to 50% at 40 °C, noncondensing
Overvoltage category	Class II
Pollution degree	2
Printing unit	Dot matrix printer 5x7, 40-character line length
Printing speed	1.2 lines per second
Ribbon cartridge	Exchangeable, black
Paper roll	Standard paper 57.5 mm x $\varnothing$ 50 to 60 mm, integrated in housing, commercial size
Print quality	Light resistant and thermally stable printing (GLP, GMP, ISO9001)
Interface	RS232C
Printer dimensions	(WxDxH) 120 mm x 203 mm x 73 mm
Packaging dimensions	(WxDxH) 255 mm x 205 mm x 150 mm
Net weight	740 g (paper roll incl.)
Compatibility limits	<ul style="list-style-type: none"> <li>• Function Date / Time: not applicable on balances with built-in clock (built-in clock has priority)</li> <li>• Functions Zeroing / Taring, Statistics and Totalization: not applicable on all models of balances</li> </ul>



# CONTENIDO

<b>General</b> .....	<b>65</b>
<b>1 Introducción</b> .....	<b>66</b>
1.1 Descripción.....	66
1.2 Características.....	66
1.3 Contenido del paquete.....	66
<b>2 Procedimiento de puesta en marcha</b> .....	<b>67</b>
2.1 Indicaciones de seguridad.....	67
2.2 Fuente de alimentación.....	67
2.3 Configuración de la impresora.....	68
2.3.1 Configuración de la impresora con el software incluido.....	68
2.3.2 Configuración de la impresora usando sólo la impresora.....	72
2.4 Instalación de la impresora.....	72
2.4.1 Conexión de la impresora con el instrumento.....	72
2.4.2 Encendido de la impresora.....	72
2.4.3 Inserción del papel.....	73
<b>3 Funciones de teclas</b> .....	<b>74</b>
<b>4 Menu</b> .....	<b>75</b>
4.1 Estructura del menu.....	66
4.2 Ejemplo de impresión.....	66
4.3 Aplicaciones.....	66
<b>5 Prueba de la impresora</b> .....	<b>78</b>
<b>6 Mantenimiento</b> .....	<b>78</b>
6.1 Cambio del rollo de papel.....	78
6.2 Reemplazo de la cinta de tinta.....	78
6.3 Limpieza.....	79
6.4 Eliminación de residuos.....	79
<b>7 Solución de problemas</b> .....	<b>80</b>
<b>8 Configuraciones recomendadas</b> .....	<b>82</b>
<b>9 Consumibles y repuesto</b> .....	<b>83</b>

<b>10 Puerto RS232C.....</b>	<b>83</b>
<b>11 Datos técnicos.....</b>	<b>84</b>

## General

### Controles

### Conexiones



- 1 Interruptor de encendido I/O
- 2 Luz piloto; indicador de estado
- 3 Panel de control
- 4 Entrada de corriente
- 5 Conector de puerto

### Panel de control

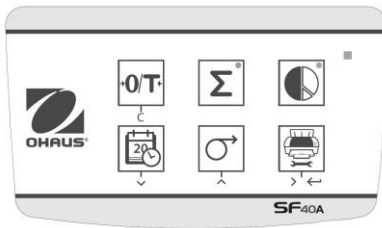

### Funciones

Taste	SF40A
	<ul style="list-style-type: none"> <li>• Puesta en cero/Tara de la balanza</li> <li>• Abortar – Salir</li> </ul>
	<ul style="list-style-type: none"> <li>• Impresión de fecha y hora</li> <li>• Opción de menú de desplazamiento hacia abajo</li> </ul>
	<ul style="list-style-type: none"> <li>• Alimentación de papel</li> <li>• Opción de menú de desplazamiento hacia arriba</li> </ul>
	<ul style="list-style-type: none"> <li>• Impresión de valores de peso estable</li> <li>• Abrir el menú                             <ul style="list-style-type: none"> <li>- seleccionar la siguiente opción del menú</li> </ul> </li> <li>• Guardar configuraciones</li> </ul>
	<ul style="list-style-type: none"> <li>• Aplicación de totalización</li> </ul>
	<ul style="list-style-type: none"> <li>• Aplicación de estadísticas</li> </ul>

# 1 INTRODUCCIÓN

## 1.1 Descripción

La SF40A es una impresora de matriz de puntos avanzada para instrumentos OHAUS. Tiene funciones de estadísticas y totalización. La impresora SF40A también cumple con los requerimientos de los sistemas modernos de aseguramiento de la calidad como GLP, GMP, ISO9001, etc.

## 1.2 Características

- Compatible con los 13 idiomas presentes en los instrumentos Ohaus.
- Funciones de estadísticas y totalización.
- Función de cero / tara.
- Función de reloj en tiempo real.
- La impresión cumple con los requerimientos de los sistemas modernos de aseguramiento de la calidad como GLP, GMP, ISO9001, etc.
- Cumple con los requerimientos de rastreabilidad de mediciones al documentar con precisión el origen de los datos así como procedimientos de calibración.
- Cumple con los requerimientos de archivo de resultados de medición al proporcionar impresiones térmicamente estables y resistentes a la luz.
- Configuración fácil con el software proporcionado con la impresora.

## 1.3 Contenido del paquete

- Impresora
- Adaptador de corriente
- Tarjeta de garantía
- Cable RS232
- Manual de instrucciones
- Rollo de Papel
- Adaptador de cable
- Eje de rotación para el rollo de papel
- Cable de alimentación\*

Nota:

\*

América / EE.UU. Versión: 1 pieza (EE.UU.)

UE / Reino Unido version: 2 piezas (U.E + R.U)

## 2 Procedimiento de puesta en marcha

### 2.1 Indicaciones de seguridad

Se han comprobado las conexiones y los objetivos de la impresora citados en el Manual de Instrucciones. No obstante, debe realizar sus propias pruebas del producto suministrado para los métodos y propósitos para los que se pretende utilizarla. Tenga en cuenta estas indicaciones de seguridad.



- Utilice la impresora sólo en interiores y nunca en ambientes con riesgo de explosión.
- El sistema electrónico de la impresora está protegido contra la penetración de polvo y salpicaduras de líquidos. No obstante, como la carcasa no es estanca, la impresora no puede utilizarse con líquidos.
- Siga las instrucciones de limpieza (consulte el capítulo 6.3) y proteja la toma de alimentación contra ambientes húmedos.
- No abra nunca la carcasa de la impresora. Si tiene algún problema, póngase en contacto con su distribuidor autorizado de OHAUS.
- Si el equipo se utiliza de una manera no especificada por el fabricante, la protección suministrada por el equipo puede verse afectada.

### 2.2 Fuente de alimentación

Con la impresora se suministra un adaptador de CA o un cable de alimentación específico de su país. La fuente de alimentación es apta para todas tensiones de red dentro del intervalo: 100 - 240 V CA, 50 - 60 Hz (para ver las especificaciones exactas, consulte el capítulo 11).

#### Atención



- En primer lugar, compruebe que la tensión de la red local sea de 100 - 240 V CA, 50 - 60 Hz y si el conector de alimentación es válido para la toma de corriente local. Si no es así, no conecte bajo ningún concepto la impresora o el adaptador de CA a la toma de corriente y póngase en contacto con el distribuidor responsable de OHAUS.
- Enchufe el adaptador únicamente en una toma puesta a tierra.

#### Importante



- Antes de poner en marcha la balanza, compruebe que ningún cable presente daños.

- Tienda los cables de manera que no interfieran en el proceso de pesaje ni puedan resultar dañados.
- Tenga cuidado de que el adaptador de CA no entre en contacto con ningún líquido.
- El conector de alimentación debe estar accesible en todo momento.

## 2.3 Configuración de la impresora

La configuración predeterminada de la impresora es como sigue.

Header:	No Header	Baud rate:	9600
Date Format:	DD.MMM YYYY	Data bits:	8
Time Format:	24:MM:SS	Parity:	None
Char Set:	CP1252 Window Latin1	Stop bits:	1
Balance Feature:	Balance Feature Enable	Flow control:	Xon/Xoff
O/T Settings:	Perform Zero		

Hay dos formas de cambiar la configuración predeterminada:

- Utilice el software "ScaleMate" de OHAUS.
- Usando sólo en la impresora

### 2.3.1 Configuración de la impresora mediante el software ScaleMate OHAUS

- 1) Utilice el cable (Kit de interfaz RS232-USB, 30304101) y el adaptador de cable que lo acompaña para conectar el ordenador y la impresora.
- 2) Conecte la impresora a la toma eléctrica principal.
- 3) Utilice el interruptor de encendido <I/O> para encenderla.
- 4) Instale el software ScaleMate OHAUS (póngase en contacto con su distribuidor local de OHAUS para obtener el software).

- 5) Ejecute el software, haga clic en "Cancel", luego elija "SF-40A printer" y haga clic en "Enter".

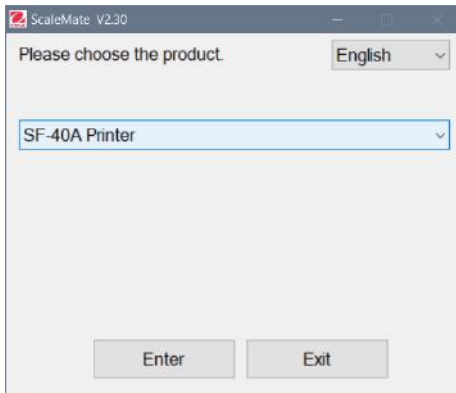
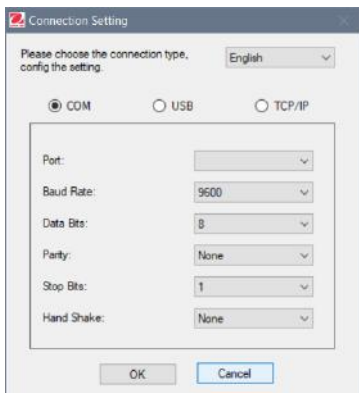

- 6) Configure el puerto COM del ordenador y haga clic en el botón "Connect". La siguiente ventana aparecerá si la conexión es exitosa, haga clic en OK para continuar.

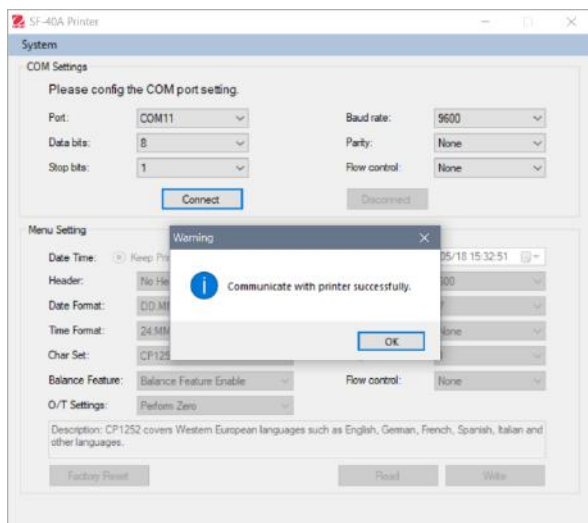

- 7) La configuración del menú de la impresora está ahora activada y se pueden cambiar todos los ajustes.

Menu Setting

Date Time:  Keep Printer Time  Current System Time  Custom 2021/05/18 05:33:06

Header: No Header Baud rate: 9600

Date Format: DD.MMM YYYY Data bits: 8

Time Format: 24:MM:SS Parity: None

Char Set: CP1252 Window Latin1 Stop bits: 1

Balance Feature: Balance Feature Enable Flow control: Xon/Xoff

O/T Settings: Perform Zero

Description: CP1252 covers Western European languages such as English, German, French, Spanish, Italian and other languages.

Factory Reset Read Write

- a. **Date Time (Fecha y hora):** Ajuste la fecha y hora para la impresora
- Keep Printer Time (Mantener hora de impresora): Mantiene la fecha y hora actuales de la impresora
  - Current System Time (Hora actual del sistema): Obtiene la fecha y hora de su computadora
  - Custom (Personalizar): Ajuste la fecha y hora manualmente
- Nota:** La fecha y la hora de la balanza tienen prioridad cuando:
- la balanza/bascula tiene fecha y hora integrados
  - la función de balanza en SF40A está deshabilitada
- b. **Header (Encabezado):** Establezca el encabezado del contenido de impresión
- No header (Sin encabezado): Ningún encabezado para el contenido de impresión
  - Date/Time (Fecha/hora): Encabezado con fecha y hora
  - Date/Time/Balance (Fecha/hora/balanza): Encabezado con fecha, hora y S/N (número serial).
- c. **Date Format (Formato de fecha):** Defina el formato de fecha
- d. **Time Format (Formato de hora):** Defina el formato de hora
- e. **Char Set (Configuración de caracteres):** Defina la página de código para diferentes idiomas



- CP 1252 Window Latin1: Cubre idiomas europeos occidentales como inglés, alemán, francés, español e italiano.
- CP 1251 Window Cyrillic: Cubre idiomas que usan alfabeto cirílico como el ruso, búlgaro y cirílico serbio.
- CP437 MS-DOS Latin US: Cubre idiomas europeos occidentales como inglés, alemán, francés, español e italiano.
- CP852 MS-DOS Latin2: Cubre idiomas de Europa central que usan el alfabeto latino como el bosnio polaco, checo, húngaro, croata, rumano, serbio y eslovaco.
- CP860 MS-DOS Portuguese: Cubre el idioma portugués

f. **Balance Feature (Función de balanza):**

1) Habilite o inhabilite una función de la impresora: 0/T, estadísticas, totalización

2) Estado de conexión de la impresora: La luz LED destellará o permanecerá iluminada.

- Balance Feature Enabled (Función de balanza habilitada): La funciones 0/T, estadísticas y totalización funciones de la impresora están habilitadas. La luz LED de estado de conexión de la impresora destellará si se pierde la conexión con la balanza.
- Balance Feature Disable (Función de balanza inhabilitada): Las funciones 0/T, estadísticas y totalización funciones de la impresora están inhabilitadas. La luz piloto / indicador de estado conexión de la impresora se iluminará incluso si se pierde la conexión con la balanza.

g. **0/T Setting (Configuración 0/T):** Configure la función del botón 0/T

- Perform Zero (Poner en cero): Ejecute la función de puesta en cero al presionar el botón.
- Perform Tare (Ejecutar tara): Realice la función de tara al presionar el botón.

h. **Baud rate (Tasa de baudios), Data bits (Bits de datos), Parity (Paridad), Stop bits (Bits de parada), Flow control (Control de flujo):** Defina los parámetros de la configuración RS232.

Las configuraciones deberán ser las mismas del instrumento que va a conectar. Para las configuraciones RS232 del instrumento, consulte el manual del instrumento.

Factory Reset

Reinicia la impresora a la configuración predeterminada de fábrica.

- Tasa de baudios: 9600
- Bits de datos: 8
- Paridad: ninguna
- Bits de parada: 1
- Control de flujo: Xon / Xoff

Read

Obtiene la configuración de la impresora.

Write

Guarda la configuración para la impresora.

- 8) Haga clic en el botón "Write" para guardar la configuración en la impresora.

### 2.3.2 Configuración de impresora usando sólo la impresora

- 1) Conecte la impresora a la toma eléctrica principal.
- 2) Use el interruptor de encendido <I/O> para encenderla.
- 3) Presione y mantenga así el botón «  » para ingresar en la lista del menú; la impresora imprimirá

“-----Menu-----”.

Presione «  » para seleccionar el elemento que va a cambiar.

Presione «  » para cambiar el parámetro.

Presione y mantenga así «  » para guardar y salir.

Presione «  » para salir sin guardar.

La impresora imprimirá el contenido para mostrar el resultado de cada operación.

Para ver la estructura completa del menú, consulte el capítulo 4.

Para controlar el numero de versión de SF40A utilice el interruptor de

encendido <I/O> mientras tienes presionado el botón «  ». Cuando la

impresora empieza a imprimir, se puede dejar de mantener presionado el botón.

## 2.4 Instalación de la impresora

La impresora detecta los ajustes del equipo. Proceda como se describe a continuación:

### 2.4.1 Conexión de la impresora al equipo

- Conecte el cable RS232 y el adaptador a la salida de la impresora y a la salida del equipo
- Encienda el equipo.

### 2.4.2 Encendido de la impresora







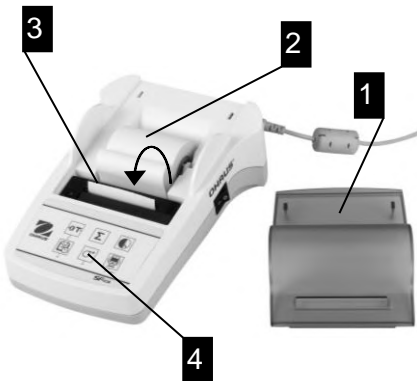







- Conecte la impresora a la toma eléctrica.
- Utilice el interruptor de encendido <I/O> para encenderla.
- Solo interface RS232: el piloto parpadeará hasta que se conecte un equipo. Si la luz sigue parpadeando, consulte el capítulo 7.

### 2.4.3 Inserción de papel

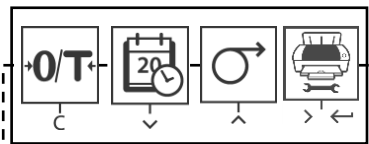

- Retire la cubierta del papel (tirando de la parte trasera) (1).
- Inserte el eje giratorio del papel en el rollo de papel (2).
- Introduzca el papel por la ranura de la unidad de impresión en el sentido de la flecha (3).
- Pulse y mantenga el botón hasta que se haya introducido suficiente papel (4).
- Pase el papel por la ranura de la cubierta.
- Vuelva a colocar la cubierta del papel (1).

### 3 Funciones de tecla

	 Pulsando brevemente	 Pulsando y manteniendo
<b>Nivel operativo</b>	 puesta a cero/tara de la balanza	
	 impresión de fecha y hora	
	 avance de línea	 avance continuo (si mantiene pulsado)
	 impresión	 apertura de menú
<b>Nivel de menú</b>	 <p>Abortar/Salir    bajars    subir    siguiente</p>	 guardar
	<b>Nivel de función</b>	 iniciar aplicación totalización
 iniciar aplicación estadística		 finalizar aplicación estadística

## 4 Menú

### 4.1 Estructura del menu

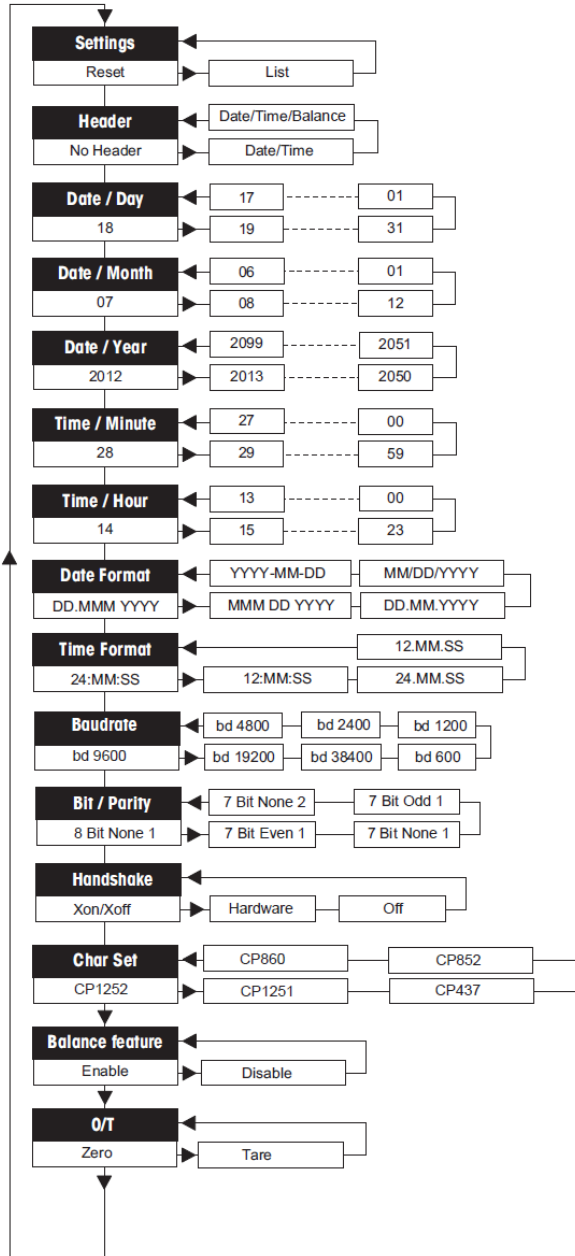























## 4.2 Ejemplo de impresión

```
-----MENU-----  
  
Ajustes:  
  
  * List  
  
Encabezado:  
  
  * No Header  
  
Día:  
  
  31  
  
Mes:  
  
  07  
  
Año:  
  
  2012  
  
Minutos:  
  
  00  
  
Hora:  
  
  18
```

\* configuración de fábrica

## 4.3 Aplicaciones

 Pulsando brevemente	 Pulsando y manteniendo
<p><b>Aplicación Estadística<sup>1)</sup></b></p> <div style="display: flex; align-items: center;">  <div style="margin-left: 20px;"> <p>→ Iniciar "Aplicación Estadística" (diodo encendido).</p> </div> </div> <div style="display: flex; align-items: center; margin-top: 10px;">  </div>	<p><b>Aplicación Totalización<sup>2,3,4)</sup></b></p> <div style="display: flex; align-items: center;">  <div style="margin-left: 20px;"> <p>→ Iniciar "Aplicación Totalización" (diodo encendido).</p> </div> </div> <div style="display: flex; align-items: center; margin-top: 10px;">  </div>
<div style="display: flex; align-items: center;">  <div style="margin-left: 20px;"> <p>→ Añadir una nueva muestra y pulsar</p> </div> </div> <div style="display: flex; align-items: center; margin-top: 10px;">  <div style="margin-left: 20px;"> <p>«  »</p> </div> </div>	<div style="display: flex; align-items: center;">  <div style="margin-left: 20px;"> <p>→ Añadir una nueva muestra y pulsar</p> </div> </div> <div style="display: flex; align-items: center; margin-top: 10px;">  <div style="margin-left: 20px;"> <p>«  »</p> </div> </div>
<div style="display: flex; align-items: center;">  <div style="margin-left: 20px;"> <p>→ Si es necesario imprimir el subtotal, pulsar la tecla</p> </div> </div> <div style="display: flex; align-items: center; margin-top: 10px;">  <div style="margin-left: 20px;"> <p>«  »</p> </div> </div>	<div style="display: flex; align-items: center;">  <div style="margin-left: 20px;"> <p>→ Si es necesario imprimir el subtotal, pulsar la tecla</p> </div> </div> <div style="display: flex; align-items: center; margin-top: 10px;">  <div style="margin-left: 20px;"> <p>«  »</p> </div> </div>
<div style="display: flex; align-items: center;">  <div style="margin-left: 20px;"> <p>→ Imprimir y finalizar la "Aplicación Estadística" (diodo apagado).</p> </div> </div> <div style="display: flex; align-items: center; margin-top: 10px;">  </div>	<div style="display: flex; align-items: center;">  <div style="margin-left: 20px;"> <p>→ Imprimir y finalizar la "Aplicación Totalización" (diodo apagado).</p> </div> </div> <div style="display: flex; align-items: center; margin-top: 10px;">  </div>

**Notas importantes•**

No está permitido cambiar de unidad durante la aplicación.

- 1) Un máximo de 999 muestras por cada aplicación puede ser guardado
- 2) Peso mínimo de la muestra debe ser mayor que 1 quinques.
- 3) Durante el cambio de la muestra, la lectura de la escala necesita ser cambiado en más de 100d, de lo contrario la impresora no registrar el cambio de la muestra.
- 4) Aplicaciones de Estadísticas incluyen: Número de muestras, el valor promedio, desviación estándar, min, max, min-max diferenciación y el peso total.

## 5 Prueba de la impresora

La Impresora está equipada con una función de autocomprobación que imprime automáticamente el conjunto de caracteres de la impresora (IBM/DOS estándar).

### Comenzar la prueba



Pulse la tecla  y conecte la impresora. Se imprimirá el conjunto de caracteres.

### Terminar la prueba



Desconecte la impresora.

## 6 Mantenimiento

En condiciones normales, la impresora no requiere prácticamente mantenimiento. En caso de necesidad, el departamento de servicio técnico de OHAUS está a su disposición. No dude en contactar con su representante de OHAUS para obtener más detalles.

### 6.1 Cambio del rollo de papel

La inserción de un nuevo rollo de papel se describe en el capítulo 2.4. Encontrará referencia de rollos de papel en el capítulo 9 sobre consumibles.

**Nota:** Utilice el eje giratorio del rollo de papel sustituido.

### 6.2 Reemplazo de la cinta de tinta



- Retire la cubierta del papel (1).
- Saque el papel de la unidad de impresión tirando de él (2).





- Para quitar el cartucho de la cinta, presione en el sentido de la flecha (3).
- Inserte la nueva cinta y, si es necesario, ténsela girando la rueda (4). Encontrará la referencia de la cinta en capítulo 9 sobre consumibles.
- La inserción de un nuevo rollo de papel se describe en el capítulo 2.4.

### 6.3 Limpieza

Puesto que la carcasa de la impresora está fabricada con materiales de primera calidad, se puede utilizar para su limpieza cualquier producto comercial (consulte las indicaciones de seguridad del capítulo 2.1).

### 6.4 Eliminación de residuos



De conformidad con las exigencias de la directiva europea 2002/96/EC sobre residuos de aparatos eléctricos y electrónicos (RAEE), este equipo no puede eliminarse como basura doméstica. Esta prohibición es asimismo válida para los países que no pertenecen a la UE cuyas normativas nacionales en vigor así lo reflejan. Elimine este producto, según las disposiciones locales, mediante el sistema de recogida selectiva de aparatos eléctricos y electrónicos. Si tiene alguna pregunta al respecto, diríjase a las autoridades responsables o al distribuidor que le proporcionó el equipo. Si transfiere este equipo (por ejemplo, para la continuación de su uso con fines privados, comerciales o industriales), deberá transferir con él esta disposición. Muchas gracias por su contribución a la conservación medioambiental.

## 7 Solución de problemas

Fallo / Mensaje	Posible causa	Solución
Impresión ilegible	<ul style="list-style-type: none"> <li>• La cinta de tinta está desgastada o enredada.</li> <li>• La unidad de impresión está llegando al final de su vida útil.</li> </ul>	<ul style="list-style-type: none"> <li>• Cambie la cinta o ténsela.</li> <li>• Póngase en contacto con el servicio técnico de OHAUS</li> </ul>
La luz piloto/indicador de estado no se enciende	<ul style="list-style-type: none"> <li>• No hay corriente.</li> <li>• Falla la fuente de alimentación.</li> </ul>	<ul style="list-style-type: none"> <li>• Conecte la impresora.</li> <li>• Póngase en contacto con el servicio técnico de OHAUS.</li> </ul>
La luz piloto/indicador de estado parpadea	<ul style="list-style-type: none"> <li>• No hay conexión con la impresora.</li> <li>• La impresora no ha encontrado los ajustes del equipo conectado.</li> </ul>	<ul style="list-style-type: none"> <li>• Asegúrese de que la impresora y el equipo están conectados.</li> <li>• Desconecte/conecte la impresora.</li> <li>• Alternativamente, cambie los ajustes de la impresora o del equipo conectado (consulte el capítulo 8).</li> </ul>
-----Timeout -----	<ul style="list-style-type: none"> <li>• La transferencia de datos no se ha completado en los últimos 45 s.</li> </ul>	<ul style="list-style-type: none"> <li>• Mueva la balanza a una ubicación más estable.</li> <li>• Compruebe la balanza.</li> </ul>
----- Over Load -----	<ul style="list-style-type: none"> <li>• La balanza está pesando por encima de su carga máxima.</li> <li>• Puesta a cero fuera de la zona de regulación del cero.</li> </ul>	<ul style="list-style-type: none"> <li>• Compruebe el peso de la muestra</li> <li>• Cambio de la zona de regulación del cero de la balanza.</li> <li>• Cambio de la configuración de la impresora de cero a tara.</li> </ul>
----- Under Load ----	<ul style="list-style-type: none"> <li>• La balanza está pesando por debajo de su carga mínima. El plato de pesada no está (bien) colocado.</li> </ul>	<ul style="list-style-type: none"> <li>• Compruebe la balanza.</li> </ul>
--Transmission Error--	<ul style="list-style-type: none"> <li>• El equipo no entiende las instrucciones de la impresora.</li> </ul>	<ul style="list-style-type: none"> <li>• Compruebe los ajustes de los parámetros del interface en la impresora y en el equipo.</li> </ul>
-- Not Executable ---	<ul style="list-style-type: none"> <li>• El equipo no puede ejecutar las instrucciones de la impresora.</li> </ul>	<ul style="list-style-type: none"> <li>• Compruebe el equipo.</li> </ul>
--Date/Time Not Set -- ---- Memory Error ----	<ul style="list-style-type: none"> <li>• Mensajes de error de la impresora.</li> </ul>	<ul style="list-style-type: none"> <li>• Compruebe el equipo.</li> <li>• Reinicie la impresora</li> <li>• Configure la fecha y la hora.</li> <li>• La batería de back up está llegando al final de su vida útil. Póngase en contacto con el servicio técnico de OHAUS.</li> </ul>
----- Memory full -----	<ul style="list-style-type: none"> <li>• Memoria de estadística o totalización llena (más de 999 muestras)</li> </ul>	<ul style="list-style-type: none"> <li>• Inicie una nueva aplicación estadística o de totalización.</li> </ul>

Fallo / Mensaje	Posible causa	Solución
-Load/Unload Weight -	<ul style="list-style-type: none"><li>• No hay ninguna muestra, o es la misma, sobre el plato de pesada.</li></ul>	<ul style="list-style-type: none"><li>• Deposite una nueva muestra o retírela y vuélvala a colocar sobre el plato.</li></ul>
Unit change not allowed!	<ul style="list-style-type: none"><li>• Se ha cambiado la unidad durante la aplicación estadística o de totalización.</li></ul>	<ul style="list-style-type: none"><li>• Reinicie la balanza.</li><li>• Cambie la unidad volviendo a establecer la anterior.</li></ul>
-- Out of range --	<ul style="list-style-type: none"><li>• El peso de la muestra está fuera de margen.</li></ul>	<ul style="list-style-type: none"><li>• El peso de la muestra debe estar dentro del margen del 70% - 130% del valor medio actual.</li></ul>

## 8 Configuraciones recomendadas

Dispositivo conectado	Ajustes del dispositivo	Ajustes de la impresora
DV, AV, PA, AR, AX, PX, SP, TA, NV, NVL, NVT, MB35/45, MB23/25, MB90/120 (T31P, T51P, T71P, T32XW, T32WE, T51 XW, T71XW, CKW)*	Modo de impresora Baud rate: 9600 Bit / Parity: 8 bit None 1 Handshake: Xon/Xoff	Ajustes de fábrica
EX	Modo de impresora Baud rate: 9600 Bit/Parität: 8 bit None 1 Handshake: Xon/Xoff	Ajustes de fábrica
ruso	Modo de impresora Baud rate: 9600 Bit/Parität: 8 bit None 1 Handshake: Xon/Xoff Idioma: ANSI/WIN ruso	CP1251 Windows Cyrillic
polaco	Modo de impresora Baud rate: 9600 Bit/Parität: 8 bit None 1 Handshake: Xon/Xoff Idioma: ANSI/WIN polaco	CP852 MS-DOS Latin2
checo	Modo de impresora Baud rate: 9600 Bit/Parität: 8 bit None 1 Handshake: Xon/Xoff Idioma: ANSI/WIN checo	CP852 MS-DOS Latin2
húngaro	Modo de impresora Baud rate: 9600 Bit/Parität: 8 bit None 1 Handshake: Xon/Xoff Idioma: ANSI/WIN húngaro	CP852 MS-DOS Latin2
portugués	Modo de impresora Baud rate: 9600 Bit/Parität: 8 bit None 1 Handshake: Xon/Xoff Idioma: ANSI/WIN portugués	CP860 MS-DOS portugués
Inglés, francés, alemán, italiano, español, chino, japonés, coreano	Modo de impresora Baud rate: 9600 Bit/Parität: 8 bit None 1 Handshake: Xon/Xoff	Ajustes de fábrica

**Nota:** \* Las funciones estadísticas y totalización de la impresora son compatibles con los siguientes modelos: DV, EX, AV, PA, NV, MB23/25, AX, PX.

Sólo la función de impresión es compatible con todos los modelos.

## 9 Consumibles y repuestos

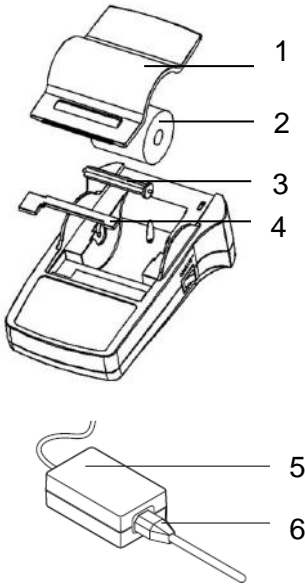

Pos.	Pieza	N.º de pedido	Cantidad suministrada
1	Cubierta del papel	30047939	1 ud
2	Rollo de papel	12120799	1 ud
3	Eje giratorio del papel	30063920	1 ud
4	Cartucho de cinta, tinta negra	30529322	1 uds
5	Adaptador de CA / CC (sin cable de alimentación) 100 - 240 V CA, 50 - 60 Hz, 12 V CC 2.5 A	30529321	1 ud
6	Cable de alimentación CH Cable de alimentación EU Cable de alimentación US Cable de alimentación IT Cable de alimentación GB Cable de alimentación AU Cable de alimentación BR Cable de alimentación JP	30064089 12120761 12120762 30064200 12120312 12120313 83033772 12122638	1 ud 1 ud 1 ud 1 ud 1 ud 1 ud 1 ud 1 ud
-	RS9 M/F cable, 1.5 m	30529323	1 ud

## 10 Interface RS232C

La impresora SF40A está equipada con un interface RS232C para su conexión a equipos de OHAUS.

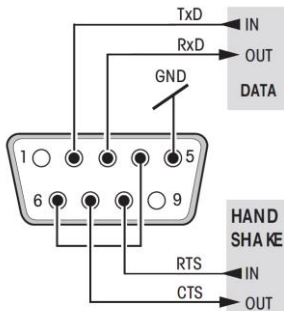

- Conector macho de 9 pines.
- Compatible con otros equipos (parámetros de transmisión) según el capítulo 8.

## 11 Datos técnicas

Requisito de alimentación	Adaptador de CA/CC: 12 VDC, 2.5 A Primario: 100 - 240 VAC, 50 - 60Hz Fluctuaciones de tensión: hasta $\pm 10\%$ de la tensión nominal Secundario: 12 VDC, 2.5 A (con protección electrónica contra sobrecargas)
Cable al adaptador de CA/CC	3 polos, con enchufe específico del país
Voltaje de red, frecuencia	12 V CC
Consumo	máx. 2.5 A
Altitud	hasta 2000 m
Temperatura ambiente	0 °C – 40 °C
Humedad relativa	máx. 80% a 31 °C; decrece linealmente hasta 50 % a 40 °C, sin condensación
Categoría de sobrevoltaje	Clase II
Grado de contaminación	2
Unidad de impresión	Impresora matricial 5 x 7, long. línea: 24 caracteres
Velocidad de impresión	1.2 líneas por segundo
Cartucho de cinta	reemplazable, tinta negra
Rollo de papel	papel estándar 57.5 mm x diám. 50 a 60 mm, integrado en la carcasa, tamaño comercial
Calidad de impresión	impresión velocísima y térmicamente estable (según buenas prácticas de laboratorio y fabricación e ISO 9001)
Interface	RS232C
Dimensiones de la impresora	(LxPxA) 120 mm x 203 mm x 73 mm
Dimensiones del embalaje	(LxPxA) 255 mm x 205 mm x 150 mm
Peso neto	740 g (con rollo de papel)
Limitaciones de compatibilidad	<ul style="list-style-type: none"> <li>• Función para fecha y hora: no aplicable para balanzas con reloj incorporado (prioridad del reloj)</li> <li>• Función para puesto a cero/tarado, estadísticas y totalización de la balanza: no aplicable para todos los modelos</li> </ul>

# TABLE DES MATIÈRES

<b>Présentation générale</b> .....	<b>1</b>
<b>1 Introduction</b> .....	<b>2</b>
1.1 Description.....	2
1.2 Caractéristiques.....	2
1.3 Contenu de l'emballage .....	2
<b>2 Procédure de démarrage</b> .....	<b>3</b>
2.1 Mesures de sécurité.....	3
2.2 Alimentation.....	3
2.3 Configuration de l'imprimante.....	4
2.3.1 Configuration de l'imprimante à l'aide du logiciel d'accompagnement.....	4
2.3.2 Configuration de l'imprimante à l'aide de l'imprimante seulement.....	8
2.4 Installation de l'imprimante.....	9
2.4.1 Connexion de l'imprimante à l'instrument.....	9
2.4.2 Mise en route de l'imprimante.....	9
2.4.3 Insertion du papier.....	9
<b>3 Fonctions de la frappe au clavier</b> .....	<b>10</b>
<b>4 Menu</b> .....	<b>11</b>
4.1 Arborescence du menu.....	11
4.2 Exemple d'impression.....	12
4.3 Applications.....	13
<b>5 Test de l'imprimante</b> .....	<b>14</b>
<b>6 Maintenance</b> .....	<b>14</b>
6.1 Changement du rouleau de papier .....	14
6.2 Remplacement du ruban encreur .....	14
6.3 Nettoyage .....	15
6.4 Mise au rebut .....	15
<b>7 Dépannage</b> .....	<b>16</b>
<b>8 Réglages recommandés</b> .....	<b>18</b>
<b>9 Consommables et pièces de rechange</b> .....	<b>19</b>
<b>10 Interface RS232C</b> .....	<b>20</b>

<b>11 Données techniques .....</b>	<b>62</b>
------------------------------------	-----------



## Présentation Générale

### Contrôles



### Connexions



- 1 Interrupteur Marche/Arrêt
- 2 Témoin lumineux - indicateur d'état
- 3 Panneau de contrôle
- 4 Connexion de l'alimentation
- 5 Connecteur de l'interface

### Panneau de commande

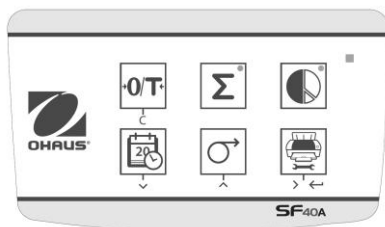

### Fonction

Taste	SF40A
	<ul style="list-style-type: none"> <li>Remise à zéro/Tarage de la balance</li> <li>Annuler - Quitter</li> </ul>
	<ul style="list-style-type: none"> <li>Copie d'écran de la date et de l'heure</li> <li>Option de défilement du menu vers le bas</li> </ul>
	<ul style="list-style-type: none"> <li>Alimentation en papier</li> <li>Option de défilement du menu vers le haut</li> </ul>
	<ul style="list-style-type: none"> <li>Impression de valeurs de poids stables</li> <li>Ouverture du menu - sélectionner l'option de menu suivante</li> <li>Enregistrement des paramètres</li> </ul>
	<ul style="list-style-type: none"> <li>Application de totalisation</li> </ul>
	<ul style="list-style-type: none"> <li>Application de statistiques</li> </ul>

# 1 Introduction

## 1.1 Description

La SF40A est une imprimante matricielle perfectionnée pour les instruments OHAUS. L'imprimante est équipée de fonctions de statistiques et de totalisation. La SF40A répond aussi aux impératifs des systèmes modernes d'assurance de la qualité tels que GLP, GMP, ISO9001, etc.

## 1.2 Caractéristiques

- Prise en charge des 13 langues présentes dans les instruments OHAUS.
- Fonctions de statistiques et de totalisation.
- Fonctions Tare/Zéro.
- Fonction d'horloge en temps réel.
- La copie papier répond aux impératifs des systèmes modernes d'assurance de la qualité tels que GLP, GMP, ISO9001, etc.
- Conformité aux impératifs de traçabilité des mesures en documentant avec précision l'origine des données ainsi que les procédures d'étalonnage.
- Répond aux impératifs d'archivage des résultats de mesure en fournissant une copie papier stable thermiquement et résistante à la lumière.
- Configuration facile avec le logiciel accompagnant l'imprimante

## 1.3 Contenu de l'emballage

- Imprimante
- Adaptateur
- Carte de garantie
- Câble RS232
- Manuel d'instructions
- Rouleau de papier
- Câble adaptateur
- Papier axe rotatif
- Câble d'alimentation\*

### Remarque :

- \* America/E.U Version : 1 pièce (E.U.)  
U.E/R.U Version : 2 pièces (R.U. + UE)

## 2 Procédure de démarrage

### 2.1 Mesures de sécurité

L'imprimante a été contrôlée en vue des connexions et usages prévus et décrits dans ce manuel d'utilisation. Ceci ne vous décharge cependant pas de vous assurer que le produit que nous vous livrons est approprié aux procédés et objectifs pour lesquels vous envisager de l'utiliser. En conséquence, respectez les consignes de sécurité suivantes.



- L'imprimante doit être utilisée uniquement à l'intérieur et jamais en atmosphère explosive.
- L'électronique de l'imprimante est protégée contre la pénétration des projections d'eau et de la poussière. Le boîtier de l'imprimante n'est toutefois pas étanche et celle-ci ne devrait pas être utilisée en présence de liquides.
- Tenir compte des consignes de nettoyage (voir chapitre 6.3). Protéger la fiche secteur contre l'humidité.
- Ne jamais ouvrir le boîtier de l'imprimante. En cas de problème éventuel avec votre imprimante, contactez votre revendeur OHAUS.
- Si l'équipement est utilisé d'une manière non spécifiée par le fabricant, la protection fournie par l'équipement peut être altérée.

### 2.2 Alimentation

Votre imprimante est livrée avec un adaptateur secteur et un câble électrique spécifique au pays. L'alimentation électrique est adaptée à toutes les tensions d'alimentation dans la plage suivante:  
100 - 240 V CA, 50 - 60 Hz (pour les spécifications exactes, voir la chapitre 11).

#### Attention



- Vérifiez d'abord que la tension d'alimentation se situe dans la plage de 100 - 240 V CA, 50 – 60 Hz et que la fiche d'alimentation s'adapte à votre rattachement d'alimentation secteur local. **Si ce n'est pas le cas, ne branchez en aucun cas l'imprimante ou l'adaptateur secteur à l'alimentation électrique**, et contactez votre revendeur OHAUS.
- Branchez uniquement l'adaptateur dans une prise reliée à la terre.

## Important



- Avant utilisation, vérifiez qu'aucun câble n'est endommagé.
- Guidez les câbles de sorte qu'ils ne puissent pas être endommagés ou interférer avec le processus de pesage!
- Veillez à ce que l'adaptateur secteur n'entre pas en contact avec des liquides!
- La prise d'alimentation doit toujours être accessible.

## 2.3 Configuration de l'imprimante

Les réglages par défaut de l'imprimante sont tels que ci-dessous.

Header:	No Header	Baud rate:	9600
Date Format:	DD.MMM YYYY	Data bits:	8
Time Format:	24.MM:SS	Parity:	None
Char Set:	CP1252 Window Latin1	Stop bits:	1
Balance Feature:	Balance Feature Enable	Flow control:	Xon/Xoff
O/T Settings:	Perform Zero		

Il existe deux moyens de modifier les réglages par défaut :

- Utilisation du logiciel d'accompagnement
- Fonctionnement seulement sur l'imprimante.

### 2.3.1 Configuration de l'imprimante à l'aide du logiciel ScaleMate OHAUS

- 1) Utilisez le câble (kit d'interface RS232-USB, 30304101) et l'adaptateur de câble fourni pour connecter l'ordinateur et l'imprimante.
- 2) Connectez l'imprimante à l'alimentation électrique principale.
- 3) Utilisez l'interrupteur principal <I/O> pour mettre l'appareil sous tension.
- 4) Installez le logiciel ScaleMate OHAUS (veuillez contacter votre revendeur OHAUS pour le logiciel).

- 5) Exécutez le logiciel, cliquez sur "Cancel", puis choisissez "SF-40A printer" et cliquez sur "Enter".

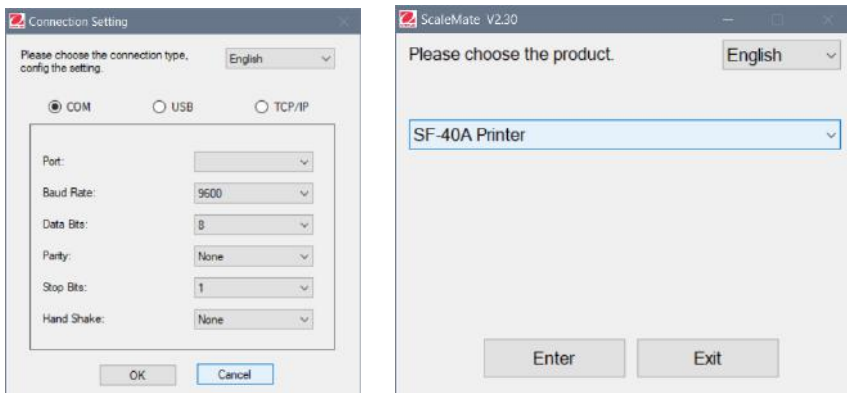

- 6) Configurez le paramètre du port COM de l'ordinateur, puis cliquez sur le bouton "Connect". La fenêtre suivante s'affiche si la connexion est réussie, cliquez sur OK pour continuer.

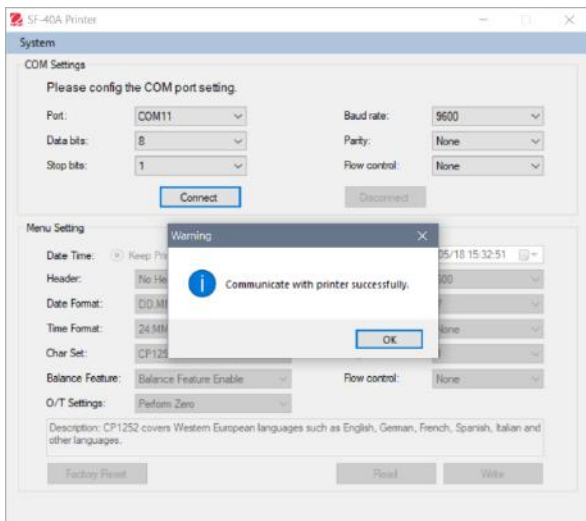

- 7) Le Menu imprimante est maintenant activé et tous les paramètres peuvent être modifiés.

a. **Date et Heure** : Réglage de la date et de l'heure de l'imprimante

- Conservation de l'heure de l'imprimante : conservation de la date et de l'heure existantes sur l'imprimante
- Heure du système en cours : obtention de la date et de l'heure à partir de votre ordinateur

Personnalisation : sélection manuelle de la date et de l'heure

**Remarque** : La date et l'heure de la balance sont prioritaires lorsque

- la balance dispose de données/heure intégrées et que
- la fonction balance de l'imprimante SF40A est activée.

b. **En-tête** : Définition de l'en-tête du contenu de l'impression

- Absence d'en-tête : absence d'en-tête pour le contenu de l'impression
- Date/Heure : en-tête avec la date et l'heure
- Date/Heure/balance : en-tête avec la date, l'heure et le numéro de série de la balance.

c. **Format de la date** : définition du format de la date

d. **Format horaire** : définition du format horaire

e. **Jeu de caractères** : définition du Code page pour les différentes langues

- CP 1252 Window Latin1 : couvre les langues de l'Europe de l'Ouest comme l'anglais, l'allemand, le français, l'espagnol et l'italien.

- CP 1251 Window Cyrillic : couvre les langues utilisant l'alphabet cyrillique comme le russe, le bulgare et le serbe.
- CP437 MS-DOS Latin US : couvre les langues de l'Europe de l'Ouest comme l'anglais, l'allemand, le français, l'espagnol et l'italien.
- CP852 MS-DOS Latin2 : couvre les langues de l'Europe Centrale qui utilisent l'écriture romaine comme le polonais de Bosnie, le tchèque, le hongrois, le croate, le serbe et le slovaque
- Portugais CP860 MS-DOS : couvre la langue portugaise

**Remarque:** le SF40A prend en charge le chinois, le coréen et le japonais, quel que soit le code de caractère.

f. **Caractéristiques de la balance :**

1) Activer/désactiver une fonction de l'imprimante : 0/T, statistiques, totalisation

2) État de la connexion de l'imprimante : Le voyant LED clignote ou reste allumé.

- Caractéristiques activées de la balance : 0/T, statistiques et totalisation fonctions de l'imprimante sont activées. Le voyant LED d'état de la connexion de l'imprimante clignotera en cas de perte de connexion avec la balance.
- Désactivation des caractéristiques de la balance : 0/T, statistiques et totalisation fonctions de l'imprimante sont activées sont désactivées. Le voyant LED d'état de la connexion de l'imprimante sera allumée même si la connexion avec la balance est perdue.

g. **Paramétrage 0/T :** configuration de la fonction du bouton 0/T

- Réalisation du zéro : réalisation de la fonction Zéro en appuyant sur le bouton.
- Réalisation de la tare : réalisation de la fonction Tare en appuyant sur le bouton.

h. **Débit en bauds, bits de données, parité, bits d'arrêt et contrôle du débit :** réglage des paramètres de la configuration RS232.

Les réglages doivent être les mêmes que ceux de l'instrument devant être connecté. Pour les paramètres RS232 de l'instrument, veuillez consulter le manuel de l'instrument.



Réinitialiser l'imprimante aux paramètres d'usine par défaut.

- Baud rate: 9600
- Data bits: 8
- Parity: None
- Stop bits: 1
- Flow control: Xon/Xoff



Obtenir les paramètres actuels de l'imprimante.

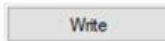

Enregistrer les paramètres sur l'imprimante.

- 8) Cliquez sur le bouton "Write" pour enregistrer les paramètres sur l'imprimante.

### 2.3.2 Configuration de l'imprimante à l'aide de l'imprimante seulement

- 1) Connecter l'imprimante au secteur.
- 2) Utiliser l'interrupteur principal <I/O> pour la mise sous tension.
- 3) Maintenir appuyé le bouton «  » pour entrer dans la liste du menu, l'imprimante imprimera

« Menu ».

Appuyer sur «  » pour choisir l'élément à modifier.

Appuyer sur «  » pour modifier les paramètres.

Maintenir «  » appuyé pour enregistrer et quitter.

Appuyer sur «  » pour quitter sans enregistrement.

L'imprimante imprimera le contenu afin de présenter les résultats de chaque opération.

Pour la structure complète du menu, consulter le chapitre 4.

Pour vérifier le numéro de version de la SF40A, utilisez l'interrupteur principal <I/O> pour mettre sous tension tout en appuyant et en maintenant



le bouton «  ». Lorsque l'imprimante commence à imprimer, relâchez le bouton.



## 2.4 Installation de l'imprimante

L'imprimante détecte les paramétrages de l'instrument. Suivez la procédure suivante:

### 2.4.1 Raccordez l'imprimante à l'instrument

- Raccordez le câble de liaison à l'interface imprimante de l'instrument et à l'imprimante elle-même.
- Mettez en marche l'instrument.

### 2.4.2 Mettez en marche l'imprimante







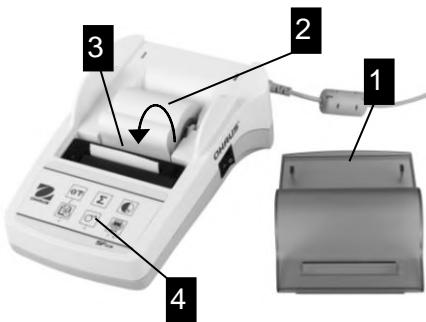









- Reliez l'imprimante à l'alimentation électrique.
- Utilisez l'interrupteur principal <I/O> Pour la mettre en marche.
- Pour l'interface RS232 seulement: le témoin clignote jusqu'au raccordement d'un instrument. Si le témoin continue de clignoter, contrôlez selon le chapitre 7.

### 2.4.3 Alimentation en papier

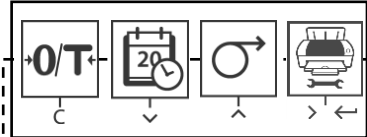

- Retirez le capot de protection (en le tirant vers l'arrière) (1).
- Placez bien l'axe de rotation Au centre du rouleau de papier (2).
- Faites passer le papier dans la fente, dans le sens indiqué par les flèches sur l'illustration ci-contre (3).
- Appuyez sur le bouton jusqu'à ce que suffisamment de papier soit déroulé (4).
- Faites dépasser le papier du capot de protection.
- Remettez le capot de protection en place (1).

### 3 Fonctions de la frappe au clavier

	 Appuyez brièvement	 Maintenez appuyé
<b>Fonctionnement</b>	 réinitialisation / tare de la balance  impression de la date et de l'heure  avance d'une ligne  impression	 Alimentation en continu (jusqu'à ce que la touche soit relâchée)  ouverture du menu
<b>Niveau menu</b>	 <p>quitter    ba    haut    suivant</p>	 enregistrement
<b>Application Level</b>	 démarrer l'application totalisation  démarrer l'application statistiques	 quitter l'application totalisation  quitter l'application statistiques

## 4 MENU

### 4.1 Arborecence du menu

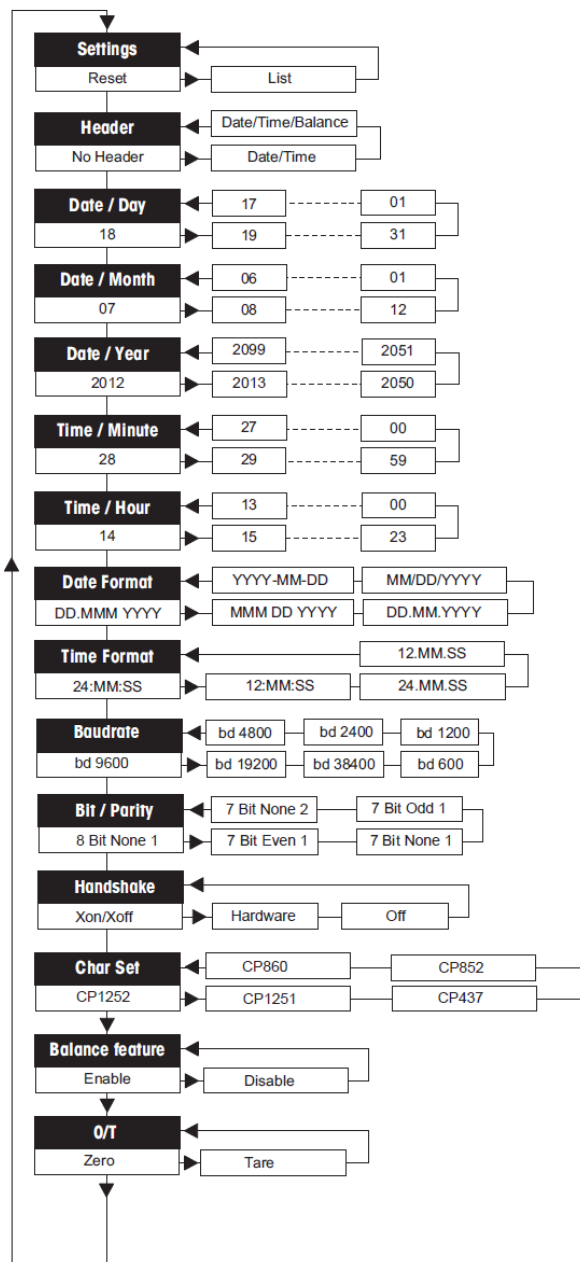























## 4.2 Exemple d'impression

```
-----MENU-----  
  
Réglages :  
  * List  
  
En-tête:  
  * No Header  
  
Jour :  
  31  
  
Mois :  
  07  
  
Année :  
  2012  
  
Minutes :  
  00  
  
Heure :  
  18
```

\* réglages d'usine

### 4.3 Applications

 Appuyez brièvement	 Maintenez appuyé
<p><b>Application statistique</b></p>  → Démarrez l'application "statistique" (LED allumée). 	<p><b>Application de totalisation</b></p>  → Démarrez "l'application de totalisation" (LED allumée). 
 → Ajoutez un nouvel échantillon et appuyez sur  «  »	 → Ajoutez un nouvel échantillon et appuyez sur  «  »
 → Si nécessaire, imprimez le sous-total en appuyant sur la touche  «  »	 → Si nécessaire, imprimez le sous-total en appuyant sur la touche  «  »
 → Imprimez et terminez "l'application statistique" (LED éteinte). 	 → Imprimez et terminez "l'application de totalisation" (LED éteinte). 

#### Remarque importante

- Le changement d'unité en cours d'application n'est pas autorisé.
- 1) Un maximum de 999 échantillons peut être stocké dans chacune des applications ci-dessus (statistiques et totalisation).
  - 2) Le poids minimum de l'échantillon doit être supérieur à 1d.
  - 3) Pendant l'application, le changement de poids de l'échantillon sur le plateau de pesée doit être supérieur à 100d, sinon l'imprimante n'enregistrera pas le changement d'échantillon.
  - 4) Le rapport pour les applications statistiques comprend : le nombre d'échantillons, la valeur moyenne, l'écart type, les valeurs min, max, le différentiel min-max et le poids total.

## 5 Test de l'imprimante

L'imprimante est dotée d'un autotest qui imprime automatiquement l'ensemble de son jeu de caractères (standard IBM/DOS).

### Démarrer le test

→ Appuyez sur la touche «  » et mettez l'imprimante en marche. L'imprimante imprime le jeu de caractères.

### Arrêter le test

→ Éteignez l'imprimante.

## 6 Maintenance

En utilisation normale, l'imprimante ne nécessite presque aucune maintenance. Le service d'assistance OHAUS est à votre disposition si une intervention est nécessaire. Pour de plus amples informations, veuillez contacter votre revendeur OHAUS.

### 6.1 Changement du rouleau de papier

La mise en place d'un nouveau rouleau de papier est décrite au chapitre 2.4. Pour connaître les références du rouleau de papier, reportez-vous à la chapitre 9 (Consommables).

**Remarque:** Vous pouvez récupérer l'axe de rotation sur l'ancien rouleau de papier.

### 6.2 Remplacement du ruban

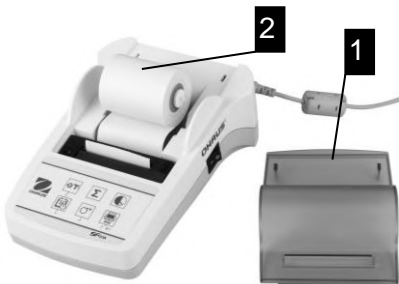

- Retirez le capot de protection (1).
- Sortez le rouleau de papier de l'imprimante (2).



- Pour retirer la cartouche de ruban, appuyez dans le sens indiqué par les flèches (3).
- Mettez en place le nouveau ruban et, si nécessaire, relâchez la pression avec la molette de tension (4).  
Pour connaître les références de la cartouche de ruban, reportez-vous à la chapitre 9 (Consommables).
- La mise en place d'un nouveau rouleau de papier est décrite au chapitre 2.4.

### 6.3 Nettoyage

Le boîtier de l'imprimante étant composé de matériaux résistants, tout nettoyant ménager ordinaire peut être utilisé. ( voir les consignes de sécurité au chapitre 2.1).

### 6.4 Mise au rebut



Conformément à la directive européenne WEEE 2002/96/CE relative à la mise au rebut des équipements électriques et électroniques (DEEE), cet appareil ne doit pas être jeté avec les déchets ménagers. Ceci est aussi valable pour les pays en dehors de l'UE conformément aux réglementations nationales en vigueur. Veuillez mettre au rebut cet appareil conformément à la législation nationale dans un conteneur séparé pour appareils électriques et électroniques. Pour toute question, adressez-vous aux autorités compétentes ou au revendeur auprès duquel vous avez acheté cet appareil. Si vous cédez la propriété de cet appareil à un tiers (pour une utilisation privée ou professionnelle), la législation en vigueur reste applicable. Merci pour votre contribution à la protection de l'environnement.

## 7 Dépannage

Panne / Message	Cause possible	Mesures à appliquer
Impression illisible	<ul style="list-style-type: none"> <li>• Ruban usagé ou emmêlé.</li> <li>• L'imprimante est usagée.</li> </ul>	<ul style="list-style-type: none"> <li>• Changez la cartouche de ruban ou tendez correctement le ruban.</li> <li>• Contactez le service d'assistance OHAUS.</li> </ul>
Le témoin lumineux ne s'allume pas	<ul style="list-style-type: none"> <li>• Aucune alimentation.</li> <li>• Bloc d'alimentation défectueux.</li> </ul>	<ul style="list-style-type: none"> <li>• Mettez l'imprimante en marche.</li> <li>• Contactez le service d'assistance OHAUS.</li> </ul>
Le témoin lumineux clignote	<ul style="list-style-type: none"> <li>• Pas de liaison entre l'imprimante et l'instrument.</li> <li>• L'imprimante n'a pas trouvé les paramètres de l'instrument raccordé.</li> </ul>	<ul style="list-style-type: none"> <li>• Contrôlez que l'imprimante et l'instrument soient bien raccordés.</li> <li>• Arrêtez et mettez en marche l'imprimante.</li> <li>• Comme alternative, modifiez les paramètres de l'imprimante ou de l'instrument raccordé (voir au chapitre 8).</li> </ul>
-----Timeout-----	<ul style="list-style-type: none"> <li>• Le transfert de données n'a pas abouti sous 45 s.</li> </ul>	<ul style="list-style-type: none"> <li>• Placez la balance dans un emplacement plus stable.</li> <li>• Vérifiez la balance.</li> </ul>
----- Over Load -----	<ul style="list-style-type: none"> <li>• Balance en surcharge.</li> </ul>	<ul style="list-style-type: none"> <li>• Vérifiez le poids de l'article.</li> </ul>
	<ul style="list-style-type: none"> <li>• Mise à zéro en dehors de la plage de réglage du zéro.</li> </ul>	<ul style="list-style-type: none"> <li>• Modifiez la plage de réglage du zéro de la balance.</li> <li>• Remplacez la configuration de l'imprimante "Mettre à zéro" sur "Tarer".</li> </ul>
----- Under Load ----	<ul style="list-style-type: none"> <li>• Balance en sous charge. Le plateau n'est pas en position.</li> </ul>	<ul style="list-style-type: none"> <li>• Vérifiez la balance.</li> </ul>
--Transmission Error--	<ul style="list-style-type: none"> <li>• L'instrument ne comprend pas l'instruction de l'imprimante.</li> </ul>	<ul style="list-style-type: none"> <li>• Contrôlez les paramètres d'interface sur l'imprimante et l'instrument.</li> </ul>
-- Not Executable ---	<ul style="list-style-type: none"> <li>• L'instrument ne peut pas exécuter l'instruction de l'imprimante.</li> </ul>	<ul style="list-style-type: none"> <li>• Contrôlez l'instrument.</li> </ul>
--- Date/Time Not Set ----- --- Memory Error ----	<ul style="list-style-type: none"> <li>• Messages d'erreur de l'imprimante</li> </ul>	<ul style="list-style-type: none"> <li>• Contrôlez l'instrument.</li> <li>• Réinitialisez l'imprimante.</li> <li>• Réglez la date et l'heure.</li> <li>• Pile de sauvegarde épuisée. Contactez le S.A.V. de OHAUS.</li> </ul>
----- Memory full -----	<ul style="list-style-type: none"> <li>• La mémoire de statistiques ou de totalisation est pleine (plus de 999 échantillons).</li> </ul>	<ul style="list-style-type: none"> <li>• Démarrez une nouvelle application. statistique ou totalisation.</li> </ul>



Panne / Message	Cause possible	Mesures à appliquer
-Load/Unload Weight -	<ul style="list-style-type: none"><li>Absence d'échantillon ou le même échantillon est sur le plateau de la balance.</li></ul>	<ul style="list-style-type: none"><li>Placez un nouvel échantillon ou enlevez celui-ci et remplacez le.</li></ul>
Unit change not allowed!	<ul style="list-style-type: none"><li>Unité changée pendant l'application de statistique ou de totalisation.</li></ul>	<ul style="list-style-type: none"><li>Réinitialisez la balance.</li><li>Remettez l'unité précédente.</li></ul>
-- Out of range --	<ul style="list-style-type: none"><li>Le poids de l'échantillon est en dehors de la plage.</li></ul>	<ul style="list-style-type: none"><li>Le poids de l'échantillon doit être compris entre 70% et 130% de la valeur moyenne courante.</li></ul>

## 8 Réglages recommandés

Dispositif raccordé	Paramétrages du dispositif	Paramétrage de l'imprimante
DV, AV, PA, AR, AX, PX, SP, TA, NV, NVL, NVT, MB35/45, MB23/25, M90/120 (T31P, T51P, T71P, T32XW, T32WE, T51 XW, T71XW, CKW)*	Mode imprimante Baud rate: 9600 Bit / Parity: 8 bit None 1 Handshake: Xon/Xoff	Réglage d'origine
EX	Drucker Modus Baud rate: 9600 Bit/Parität: 8 bit None 1 Handshake: Xon/Xoff	Réglage d'origine
Russe	Drucker Modus Baud rate: 9600 Bit/Parität: 8 bit None 1 Handshake: Xon/Xoff Langue: ANSI/WIN Russe	CP1251 Windows Cyrillic
Polonais	Drucker Modus Baud rate: 9600 Bit/Parität: 8 bit None 1 Handshake: Xon/Xoff Langue: ANSI/WIN Polonais	CP852 MS-DOS Latin2
Tchèque	Drucker Modus Baud rate: 9600 Bit/Parität: 8 bit None 1 Handshake: Xon/Xoff Langue: ANSI/WIN Tchèque	CP852 MS-DOS Latin2
Hongrois	Drucker Modus Baud rate: 9600 Bit/Parität: 8 bit None 1 Handshake: Xon/Xoff Langue: ANSI/WIN Hongrois	CP852 MS-DOS Latin2
Portugais	Drucker Modus Baud rate: 9600 Bit/Parität: 8 bit None 1 Handshake: Xon/Xoff Langue: ANSI/WIN Portugais	CP860 MS-DOS Portugais
Anglais, français, allemand, italien, espagnol, chinois, japonais, coréen	Drucker Modus Baud rate: 9600 Bit/Parität: 8 bit None 1 Handshake: Xon/Xoff	Réglage d'origine

**Note:** \* Les fonctions de statistique et de la totalisation de l'imprimante sont pris en charge dans les modèles suivants: DV, EX, AV, PA, NV, MB23/25, AX PX.

Fonction d'impression seulement est pris en charge dans tous les modèles.

## 9 Consommables et pièces de rechange

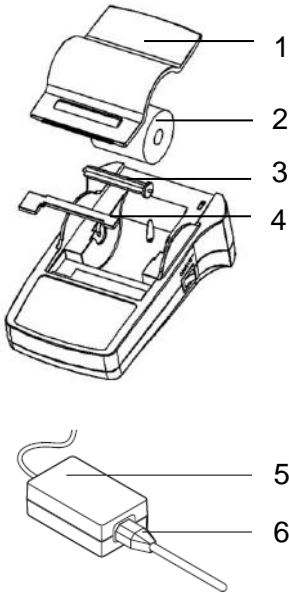

Pos.	Élément	Référence	Qté commande
1	Capot de protection	30047939	1 unité
2	Rouleau de papier	12120799	1 unité
3	Axe de rotation	30063920	1 unité
4	Cartouche de ruban (noir)	30529322	1 unité
5	Adaptateur CA/CC (sans câble d'alimentation) 100 - 240 VAC, 50 - 60 Hz, 12 VDC 2.5 A	30529321	1 unité
6	Câble d'alimentation CH	30064089	1 unité
	Câble d'alimentation EU	12120761	1 unité
	Câble d'alimentation US	12120762	1 unité
	Câble d'alimentation IT	30064200	1 unité
	Câble d'alimentation GB	12120312	1 unité
	Câble d'alimentation AU	12120313	1 unité
	Câble d'alimentation BR	83033772	1 unité
	Câble d'alimentation JP	12122638	1 unité
-	RS9 M/F cable, 1.5 m	30529323	1 unité

## 10 Interface RS232C

L'imprimante SF40A est équipée d'une interface RS232C permettant de la brancher sur les appareils OHAUS.

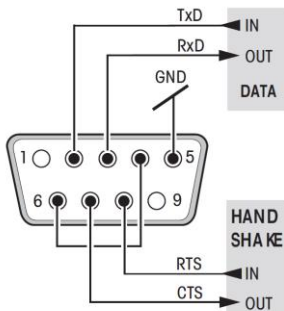

- Connecteur mâle 9 broches
- Pour l'adaptation aux paramètres de transmission de l'autre périphérique, reportez-vous à la chapitre 8.

## 11 Caractéristiques techniques

Alimentation électrique	Adaptateur CA/CC: 12 VDC, 2.5 A Primaire: 100 - 240 VAC, 50 - 60Hz Les fluctuations de tension: jusqu'à $\pm 10\%$ de la tension nominale Secondaire: 12 VDC, 2.5 A (avec protection contre les surcharges électroniques)
Câble vers adaptateur CA/CC	3 conducteurs, avec fiche spécifique au pays
Tension et fréquence	12 V CC
Consommation	Max. 2.5 A
Altitude	jusqu'à 2000 m
Température de fonctionnement	0 °C – 40 °C
Humidité relative	max. 80% à 31 °C, en décroissance constante jusqu'à 50 % à 40 °C sans condensation
Catégorie d'équipement électrique	Classe II
Niveau de pollution	2
Imprimante	Imprimante matricielle 5 x7, lignes de 24 caractères
Vitesse d'impression	1.2 lignes par seconde
Cartouche de ruban	Remplaçable, noire
Rouleau de papier	Papier ordinaire de 57.5 mm x $\varnothing$ 50 à 60 mm, placé sous le boîtier, taille légale
Qualité d'impression	Bonne tenue thermique et résistante à la lumière et à la chaleur (GLP, GMP, ISO 9001)
Interface	RS232C
Dimensions de l'imprimante	(LxPxH) 120 mm x 203 mm x 73 mm
Dimensions de l'emballage	(LxPxH) 255 mm x 205 mm x 150 mm
Poids net	740 g (rouleau de papier inclus)
Restriction de compatibilité	<ul style="list-style-type: none"> <li>• Fonction date / heure: non applicable aux balances avec horloge intégrée (l'horloge intégrée a la priorité)</li> <li>• Fonction réinitialisation / tare de la balance, statistiques et totalisation: non applicable à tous les modèles</li> </ul>

# INHALT

<b>Überblick</b> .....	<b>22</b>
<b>Einleitung</b> .....	<b>23</b>
1.1 Beschreibung.....	23
1.2 Merkmale.....	23
1.3 Packungsinhalt.....	23
<b>2 Inbetriebnahme</b> .....	<b>24</b>
2.1 Sicherheitsmaßnahmen.....	24
2.2 Stromversorgung.....	24
2.3 Druckerkonfiguration.....	25
2.3.1 Druckerkonfiguration mit beiliegender Software.....	25
2.3.2 Druckerkonfiguration nur mit Drucker.....	28
2.4 Druckerinstallation.....	29
2.4.1 Anschließen des Druckers an das Gerät.....	29
2.4.2 Einschalten des Druckers.....	29
2.4.3 Einlegen des Papiers.....	29
<b>3 Tastenfunktionen</b> .....	<b>30</b>
<b>4 Menü</b> .....	<b>31</b>
4.1 Menüstruktur.....	32
4.2 Druckbeispiele.....	33
4.3 Applikationen.....	33
<b>5 Druckertest</b> .....	<b>34</b>
<b>6 Wartung</b> .....	<b>34</b>
6.1 Wechseln der Papierwalze.....	34
6.2 Ersetzen des Farbbands.....	34
6.3 Reinigung.....	35
6.4 Entsorgung.....	35
<b>7 Fehlerbehebung</b> .....	<b>36</b>
<b>8 Empfohlene Einstellungen</b> .....	<b>38</b>
<b>9 Verbrauchsmaterialien und Ersatzteile</b> .....	<b>39</b>

<b>10 RS232C-Schnittstelle.....</b>	<b>39</b>
<b>11 Technische Daten.....</b>	<b>40</b>

# Überblick

## Steuerelemente



## Anschlüsse



- 1 Ein-/Ausschalter
- 2 Kontrollleuchte – Statusanzeige
- 3 Bedienfeld

## Bedienfeld

## Funktionen

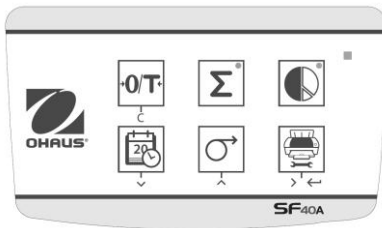

Taste	SF40A
	<ul style="list-style-type: none"> <li>• Waage nulljustieren/ tariieren</li> <li>• Abbrechen – Beenden</li> </ul>
	<ul style="list-style-type: none"> <li>• Datum und Uhrzeit drucken</li> <li>• Im Menü nach unten blättern</li> </ul>
	<ul style="list-style-type: none"> <li>• Papierzufuhr</li> <li>• Im Menü nach oben blättern</li> </ul>
	<ul style="list-style-type: none"> <li>• Stabile Gewichtswerte ausdrucken</li> <li>• Menü aufrufen</li> <li>• Nächste Menüoption auswählen</li> <li>• Einstellungen speichern</li> </ul>
	<ul style="list-style-type: none"> <li>• Summierungsanwendung</li> </ul>
	<ul style="list-style-type: none"> <li>• Statistikanwendung</li> </ul>

# 1 Einleitung

## 1.1 Beschreibung

Der SF40A ist ein moderner Punktmatrixdrucker für OHAUS-Geräte. Der Drucker verfügt über Statistik- und Summierungsfunktionen. Er erfüllt außerdem die Anforderungen moderner Qualitätssicherungssysteme wie GLP, GMP, ISO 9001 usw.

## 1.2 Merkmale

- Unterstützung aller 13 Sprachen der Ohaus-Geräte
- Statistik- und Summierungsfunktionen
- Nulljustierungs-/Tarierungsfunktion
- Echtzeitfunktion
- Der Ausdruck erfüllt die Anforderungen moderner Qualitätssicherungssysteme (GLP, GMP, ISO 9001 usw.).
- Entspricht den Anforderungen zur Nachverfolgbarkeit von Messungen durch eine präzise Dokumentation der Herkunft der Daten sowie der Kalibrierungsverfahren.
- Erfüllt die Anforderungen zur Archivierung von Messergebnissen dank wärme- und lichtbeständiger Ausdrücke.
- Einfache Konfiguration mit der im Lieferumfang des Druckers enthaltenen Software

## 1.3 Packungsinhalt

- Drucker
- Netzteil
- Garantiekarte
- RS232-Kabel
- Bedienungsanleitung
- Papierrolle
- Kabel Adapter
- Papier Drehachse
- Netzkabel\*

Hinweis:

\*

Amerika / US-Version: 1 Stück (USA),

EU / Vereinigtes Königreich Version: 2 Stück (EU + UK).



## 2 Inbetriebnahme

### 2.1 Sicherheitshinweise

Der Drucker ist für die Anschlüsse und Bestimmungen geprüft, die in dieser Bedienungsanleitung dokumentiert sind. Dies befreit Sie jedoch nicht von der eigenen Prüfung des von uns gelieferten Produktes auf seine Eignung für die von Ihnenbeabsichtigten Verfahren und Zwecke. Befolgen Sie deshalb die folgenden Sicherheitsmassnahmen.



- Der Drucker darf nicht in explosionsgefährdeten Bereichen und nur in Innenräumen betrieben werden.
- Die Elektronik des Druckers ist geschützt gegen das Eindringen von Spritzwasser und Staub. Das Druckergehäuse ist aber nicht dicht und sollte deshalb nicht in Gegenwart von Flüssigkeiten benutzt werden.
- Reinigungshinweise (siehe Kapitel 6.3) beachten. Netzstecker vor Nässe schützen.
- Druckergehäuse nicht öffnen. Falls Sie einmal Probleme mit Ihrem Drucker haben, wenden Sie sich an Ihre zuständige OHAUS-Vertretung.
- Wenn das Gerät in einer Weise, die nicht vom Hersteller angegeben verwendet wird, kann der Schutz des Geräts beeinträchtigt werden.

### 2.2 Stromversorgung

Ihr Drucker wird mit einem Netzadapter und einem länderspezifischen Netzkabel ausgeliefert. Der Netzadapter eignet sich für alle Netzspannungen im Bereich von: 100 – 240 VAC, 50 – 60 Hz (genaue Spezifikationen siehe Kapitel 11).



#### Achtung

- Prüfen, ob die Netzspannung im Bereich von 100 – 240 VAC, 50 – 60 Hz liegt und ob der Stecker in die Steckdose passt. **Sollte dies nicht der Fall sein, schliessen Sie den Drucker bzw. den Netzadapter auf keinen Fall ans Stromnetz an** und wenden Sie sich an die zuständige OHAUS-Vertretung.
- Den Adapter nur an eine Steckdose anschliessen, die geerdet ist.

#### Wichtig



- Vor Inbetriebnahme das Netzkabel auf Beschädigung prüfen.
- Verlegen Sie die Kabel so, dass sie nicht beschädigt werden können und Ihnen bei der täglichen Arbeit nicht in den Weg kommen!
- Achten Sie darauf, dass der Netzadapter nicht mit Flüssigkeiten in Berührung kommen kann!

- Der Netzstecker muss jederzeit zugänglich sein.

## 2.3 Druckerkonfiguration

Im Folgenden finden Sie die Standardeinstellungen des Druckers. Wenn Sie diese Einstellungen ändern möchten, müssen Sie den Drucker zunächst konfigurieren.

Header:	No Header	Baud rate:	9600
Date Format:	DD.MMM YYYY	Data bits:	8
Time Format:	24:MM:SS	Parity:	None
Char Set:	CP1252 Window Latin1	Stop bits:	1
Balance Feature:	Balance Feature Enable	Flow control:	Xon/Xoff
O/T Settings:	Perform Zero		

Zur Änderung der Standardeinstellungen gibt es zwei Möglichkeiten:

- Verwenden Sie die OHAUS-Software "ScaleMate".
- Nur mit dem Drucker

### 2.3.1 Druckereinrichtung mit der OHAUS-Software ScaleMate

- 1) Verwenden Sie das Kabel (Schnittstellenkit RS232-USB, #30304101) und den mitgelieferten Kabeladapter, um den Computer und den Drucker zu verbinden.
- 2) Verbinden Sie den Drucker mit der Hauptstromversorgung.
- 3) Verwenden Sie den Hauptschalter <I/O> zum Einschalten.
- 4) Installieren Sie die OHAUS-Software ScaleMate (bitte wenden Sie sich für die Software an Ihren lokalen OHAUS-Händler)
- 5) Starten Sie die Software, klicken Sie auf "Cancel", wählen Sie dann "SF-40A Printer" und klicken Sie auf "Enter".

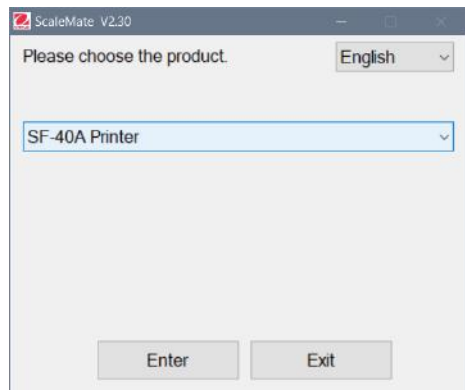
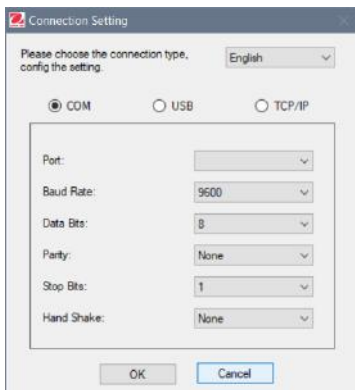

- 6) Konfigurieren Sie die COM-Port-Einstellung des Computers und klicken Sie dann auf die Schaltfläche "Connect". Das folgende Fenster wird angezeigt, wenn die Verbindung erfolgreich ist, klicken Sie auf "OK", um fortzufahren.

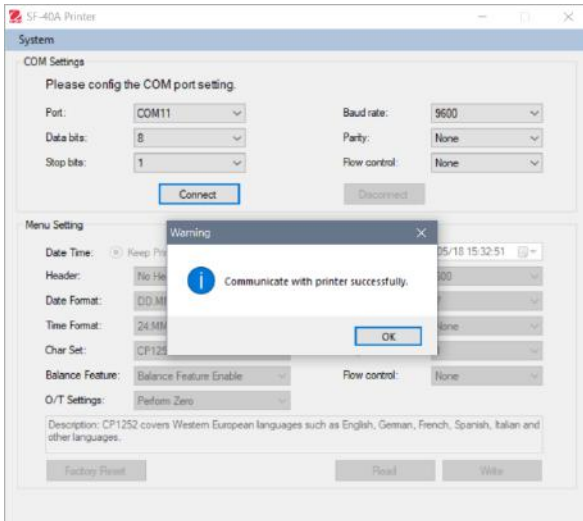

- 7) Die Einstellung des Druckermenüs ist nun aktiviert und alle Einstellungen können geändert werden.

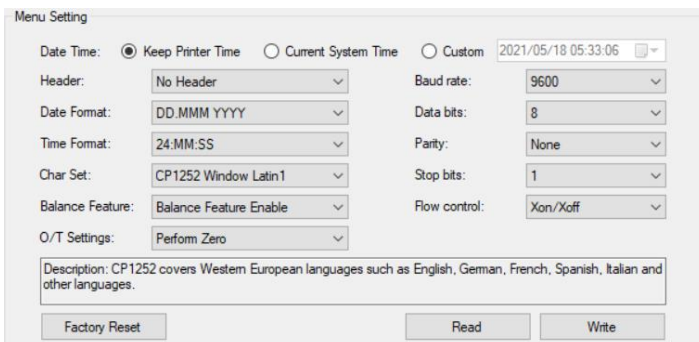

a. **Date Time (Datum/Uhrzeit):** Stellen Sie das Datum und die Uhrzeit für den Drucker ein.

- **Keep Printer Time (Uhrzeit des Druckers verwenden):** verwendet das Datum und die Uhrzeit des Druckers.

- Current System Time (Aktuelle Systemzeit): übernimmt das Datum und die Uhrzeit Ihres Computers.
- Custom (Benutzerdefiniert): manuelle Einstellung von Datum und Uhrzeit.

**Hinweis:** Datum und Uhrzeit der Waage haben Priorität wenn:

- Die Waage eigene Datum und Uhrzeit Funktion hat und
- Diese Funktion beim SF40A eingeschaltet ist

**b.Header (Kopfzeile):** Richten Sie die Kopfzeile mit dem gewünschten Druckinhalt ein.

- No header (Keine Kopfzeile): keine Kopfzeile im Ausdruck
- Date/Time (Datum/Uhrzeit): Kopfzeile mit Datum und Uhrzeit
- Date/Time/Balance (Datum/Uhrzeit/Waage): Kopfzeile mit Datum, Uhrzeit und S/N.

**c.Date Format (Datumsformat):** Stellen Sie das Datumsformat ein.

**d.Time Format (Uhrzeitformat):** Stellen Sie das Uhrzeitformat ein.

**e.Char Set (Zeichensatz):** Stellen Sie den Code für die verschiedenen Sprachen ein.

- CP 1252 Window Latin1: für westeuropäische Sprachen wie Englisch, Deutsch, Französisch, Spanisch und Italienisch
- CP 1251 Window Cyrillic: für Sprachen, die das kyrillische Alphabet verwenden, zum Beispiel Russisch, Bulgarisch und Serbisch (kyrillisch)
- CP437 MS-DOS Latin US: für westeuropäische Sprachen wie Englisch, Deutsch, Französisch, Spanisch und Italienisch
- CP852 MS-DOS Latin2: für mitteleuropäische Sprachen, die lateinische Buchstaben verwenden, zum Beispiel Polnisch, Bosnisch, Tschechisch, Ungarisch, Kroatisch, Rumänisch, Serbisch und Slowakisch
- CP860 MS-DOS Portuguese: für die portugiesische Sprache

**Hinweis:** SF40A unterstützt Chinesisch, Koreanisch und Japanisch, unabhängig vom Zeichencode.

**f.Balance Feature (Waagenfunktion):**

- 1) Eine Funktion des Druckers ein-/ausschalten: 0/T, Statistik, Summierung

2) Druckeranschlussstatus: Die LED-Leuchte blinkt oder leuchtet ständig.

- Balance Feature Enabled (Waagenfunktion aktiviert): 0/T, Statistik und Summierung Funktionen des Drucker sind aktiviert. Die LED-Leuchte für den Druckeranschlussstatus blinkt, wenn die Verbindung mit der Waage unterbrochen ist.
- Balance Feature Disabled (Waagenfunktion deaktiviert): 0/T, Statistik und Summierung Funktionen des Drucker sind deaktiviert. Die LED-Leuchte für den Druckeranschlussstatus leuchtet, selbst wenn die Verbindung mit der Waage unterbrochen ist.

g. **0/T-Settings (0/T-Einstellung):** Konfigurieren Sie die Funktion der Taste „0/T“.

- Perform Zero (Nullstellung): Beim Drücken der Taste wird die Waage auf Null gesetzt.
- Perform Tare (Tariieren): Beim Drücken der Taste wird die Waage tariert.

h. **Baud rate, Data bits, Parity, Stop bits, Flow control (Baudrate, Datenbits, Parität, Stoppbits, Flusststeuerung):** Konfigurieren Sie die Parameter der RS232-Einstellung.

Die Einstellungen sollten mit denen des angeschlossenen Geräts übereinstimmen. Die RS232-Einstellungen für das Gerät finden Sie im Gerätehandbuch.

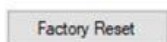

Drucker auf Werkseinstellungen zurücksetzen.

- Baudrate: 9600
- Datenbits: 8
- Parität: Keine
- Stoppbits: 1
- Flow control: Xon/Xoff

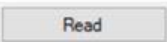

Verwendet die aktuellen Einstellungen des Druckers.

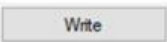

Speichert die Einstellungen für den Drucker.

8) Klicken Sie auf die Schaltfläche "Write", um die Einstellung im Drucker zu speichern.

### 2.3.2 Druckerkonfiguration nur mit Drucker

- 1) Verbinden Sie den Drucker mit der Netzstromversorgung.
- 2) Schalten Sie den Drucker mit dem Ein-/Ausschalter ein.

3) Halten Sie die Schaltfläche «  » gedrückt, um die Menüliste aufzurufen; im Drucker erscheint:

„-----Menu-----“.

Drücken Sie auf «  », um den zu ändernden Parameter auszuwählen.

Drücken Sie auf «  », um den Parameter zu ändern.

Halten Sie «  » gedrückt, um die Einstellung zu speichern und das Menü zu verlassen.

Drücken Sie auf «  », um das Menü ohne Speichern zu verlassen.

Der Drucker druckt den Inhalt, um das Ergebnis der einzelnen Vorgänge festzuhalten.

Die gesamte Menüstruktur finden Sie in Kapitel 4.

Um die Versionsnummer des SF40A herauszufinden, drücken Sie den

Startknopf <I/O> und drücken und halten gleichzeitig den Druckknopf «  ». Wenn der Drucker zu drucken beginnt, lassen Sie den Knopf los.

## 2.4 Installation des Druckers

Der Drucker erkennt die Einstellungen des angeschlossenen Gerätes. Gehen Sie dabei wie folgt vor:

### 2.4.1 Drucker anschliessen

- Verbinden Sie den Drucker und das Instrument mit dem Schnittstellenkabel.
- Schalten Sie das Gerät ein.

### 2.4.2 Drucker einschalten



- Schliessen Sie den Drucker ans Netz an.
- Schalten Sie den Drucker mit dem <I/O> Schalter ein.
- Nur bei RS232 Schnittstelle:

Die Anzeigelampe blinkt bis ein Gerät angeschlossen ist. Wenn die Lampe weiterblinkt siehe Fehlerbehebung Kapitel 7.

### 2.4.3 Papier einlegen

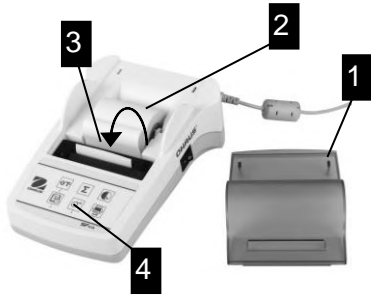

- Papierhaube entfernen (auf der Rückseite ziehen) (1).
- Papierrollen-Achse durch das Loch der Papierrolle schieben (2).
- Papier in Pfeilrichtung in den Schlitz des Druckwerks einführen (3).
- Druckertaste so lange gedrückt halten, bis genügend Papier eingezogen ist (4).
- Das Papier durch den Schlitz in der Papierhaube einführen.
- Papierhaube aufsetzen (1).

### 3 Tastenfunktionen

		Kurz drücken		Lange drücken
<b>Funktionsebene</b>		Nullstellen / Trieren der Waage		Datum und Zeit drucken
		Zeilenvorschub		Kontinuierlich drucken (solange Taste gedrückt wird)
		Drucken		Menü öffnen
<b>Menuebene</b>	<p>Beenden Ab Auf Weiter</p>			Speichern
<b>Funktionsebene</b>		Starten der Applikation "Totaling"		Beenden der Applikation "Totaling"
		Starten der Applikation "Statistik"		Beenden der Applikation "Statistik"



# 4 Menü

## 4.1 Menübaumstruktur

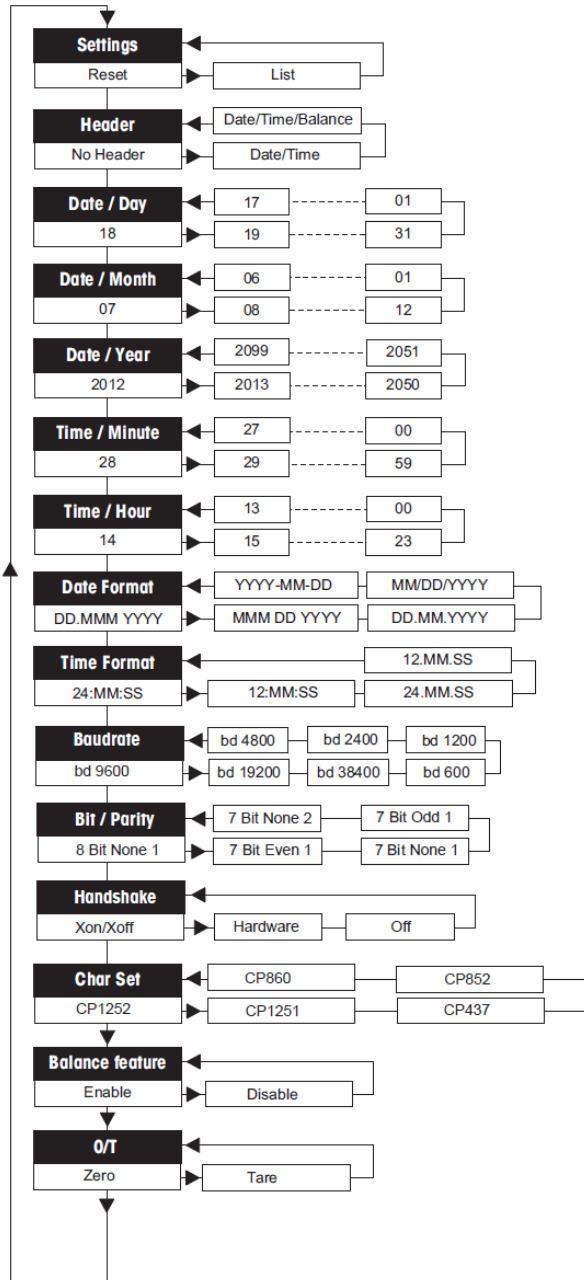























## 4.2 Druckbeispiele

```
-----MENU-----  
  
Einstellungen:  
  
  * List  
  
Kopfzeile:  
  
  * No Header  
  
Datum Tag:  
  
  31  
  
Datum Monat:  
  
  07  
  
Datum Jahr:  
  
  2012  
  
Zeit Minuten:  
  
  00  
  
Zeit Stunden:  
  
  18
```

\* Werkseinstellung

### 4.3 Applikationen

 Kurz drücken		 Lange drücken	
<b>Applikation Statistik</b>  	→ Start Applikation Statistik (LED Ein)	<b>Applikation Totalisierung</b>  	→ Start Applikation Totaling (LED Ein)
 	→ Neue Probe auflegen und Taste «  » drücken.	 	→ Neue Probe auflegen und Taste «  » drücken.
 	→ Subtotal drucken durch drücken der «  » Taste	 	→ Subtotal drucken durch drücken der «  » Taste
 	→ Drucken und Applikation Statistik beenden (LED Aus)	 	→ Drucken und Applikation Totaling beenden (LED Aus).

#### Wichtiger Hinweis

- Ändern der Einheit während der Applikation ist nicht zulässig.
  - 1) Es können maximal 999 Probenergebnisse gespeichert werden für die oben genannten Applikationen (Statistik und Totalisieren).
  - 2) Das Minimalgewicht der Probe sollte größer sein als 1d.
  - 3) Während des Austauschs der Probe muss sich die Anzeige um mehr als 100 d verändern, da sonst der Drucker den Wechsel der Probe nicht mitbekommt.

- 4) Der Statistikreport enthält: Probenanzahl, Durchschnittsgewicht, Standardabweichung, Min., Max., Min-Max-Differenz, und das Gesamtgewicht.

## 5 Drucker Test

Der Drucker besitzt einen Selbst-Test, der automatisch den abgespeicherten Zeichensatz ausdruckt. (Werkseinstellung IBM/DOS).

- |                           |   |                                                                                                                                                         |
|---------------------------|---|---------------------------------------------------------------------------------------------------------------------------------------------------------|
| Test starten              | → | Drücken der Taste «  » und Drucker einschalten. Der Drucker druckt den |
| gespeicherten Zeichensatz |   | aus.                                                                                                                                                    |
| Test abbrechen            | → | Drucker ausschalten.                                                                                                                                    |

## 6 Wartung

Unter normalen Betriebsbedingungen ist der Drucker praktisch wartungsfrei. Kommt es trotzdem zu einem Ausfall, steht Ihnen der OHAUS Service jederzeit zur Verfügung. Bitte erkundigen Sie sich bei Ihrer zuständigen OHAUS-Vertretung.

### 6.1 Druckerpapier ersetzen

Das Einsetzen der neuen Papierrolle ist unter Kapitel 2.4 beschrieben. Die Bestellnummer für die Papierrolle siehe unter Kapitel 9 (Verbrauchsmaterial).

**Hinweis:** Die Papierrollen-Achse ist immer von der alten Papierrolle auf die Neue zu übernehmen!

### 6.2 Farbband ersetzen



- Papierhaube vom Drucker entfernen (1).
- Papier aus dem Druckwerk ziehen (2).



- Farbbandkassette entfernen durch Drücken in Pfeilrichtung (3).
- Neues Farbband einsetzen, falls nötig mit Spannrad spannen (4). Die Bestellnummer für das Farbband siehe unter Kapitel 9 (Verbrauchsmaterial).
- Das Einsetzen der Papierrolle ist unter Kapitel 2.4 beschrieben.

### 6.3 Reinigung

Das Druckergehäuse ist aus hochwertigen Materialien hergestellt. Zur Reinigung können deshalb handelsübliche milde Reinigungsmittel verwendet werden (siehe Sicherheitshinweise Kapitel 2.1).

### 6.4 Entsorgung



In Übereinstimmung mit den Anforderungen der Europäischen Richtlinie 2002/96/EG über Elektro- und Elektronik-Altgeräte (WEEE) darf dieses Gerät nicht mit dem Hausmüll entsorgt werden. Sinngemäss gilt dies auch für Länder ausserhalb der EU entsprechend den geltenden nationalen Regelungen. Bitte entsorgen Sie dieses Produkt gemäss den örtlichen Bestimmungen in einer getrennten Sammlung für Elektro- und Elektronikgeräte. Bei allfälligen Fragen wenden Sie sich bitte an die zuständige Behörde oder den Händler, bei dem Sie dieses Gerät erworben haben. Bei Weitergabe dieses Gerätes (z.B. für private oder gewerbliche/industrielle Weiternutzung) ist diese Bestimmung sinngemäss weiterzugeben. Vielen Dank für Ihren Beitrag zum Schutz der Umwelt.

## 7 Fehlerbehebung

Störung / Anzeige	Mögliche Ursache	Massnahme
Druckbild unleserlich	<ul style="list-style-type: none"> <li>• Farbband verbraucht oder verwickelt</li> <li>• Druckwerk Lebensdauer erreicht</li> </ul>	<ul style="list-style-type: none"> <li>• Farbband ersetzen oder spannen</li> <li>• Bitte kontaktieren Sie den OHAUS Service</li> </ul>
Grüne Anzeigelampe leuchtet nicht	<ul style="list-style-type: none"> <li>• Keine Netzspannung</li> <li>• Netzteil defekt</li> </ul>	<ul style="list-style-type: none"> <li>• Drucker einschalten.</li> <li>• Bitte kontaktieren Sie den OHAUS Service</li> </ul>
Anzeigelampe blinkt	<ul style="list-style-type: none"> <li>• Keine Verbindung zum Drucker.</li> <li>• Der Drucker findet die Einstellungen des Angeschlossenen Gerätes nicht.</li> </ul>	<ul style="list-style-type: none"> <li>• Verbindung zwischen Drucker und Gerät überprüfen.</li> <li>• Drucker aus/einschalten</li> <li>• Gegebenenfalls Übertragungsparameter beim angeschlossenen Gerät ändern. (siehe Kapitel 8)</li> </ul>
-----Timeout -----	<ul style="list-style-type: none"> <li>• Datenübermittlung kann nicht innerhalb 45 s abgeschlossen werden.</li> </ul>	<ul style="list-style-type: none"> <li>• Aufstellungsort der Waage überprüfen, allenfalls zu unruhig.</li> <li>• Waage überprüfen.</li> </ul>
----- Over Load -----	<ul style="list-style-type: none"> <li>• Wägebereich der Waage wurde überschritten.</li> <li>• Nullstellen ausserhalb des Nullbereichs.</li> </ul>	<ul style="list-style-type: none"> <li>• Wägegut überprüfen.</li> <li>• Nullstellbereich der Waage ändern.</li> <li>• Die Einstellung des Druckers von "Nullen" auf "Trieren" ändern.</li> </ul>
----- Under Load ----	<ul style="list-style-type: none"> <li>• Waage im Unterlastbereich. Waagschale ist nicht richtig montiert.</li> </ul>	<ul style="list-style-type: none"> <li>• Waage überprüfen.</li> </ul>
--Transmission Error--	<ul style="list-style-type: none"> <li>• Gerät versteht die Anweisung des Druckers nicht.</li> </ul>	<ul style="list-style-type: none"> <li>• Übertragungsparameter an Drucker und Waage überprüfen.</li> </ul>
-- Not Executable ---	<ul style="list-style-type: none"> <li>• Gerät kann die Druckerbefehle nicht ausführen.</li> </ul>	<ul style="list-style-type: none"> <li>• Gerät überprüfen.</li> </ul>
--- Date/Time Not Set ----- --- Memory Error -----	<ul style="list-style-type: none"> <li>• Druckerfehler Anzeige.</li> </ul>	<ul style="list-style-type: none"> <li>• Gerät überprüfen.</li> <li>• Druckereinstellungen zurückstellen (Reset).</li> <li>• Datum/Zeit einstellen.</li> <li>• Back-up Batterie erschöpft. Bitte kontaktieren Sie den OHAUS Service.</li> </ul>
----- Memory full -----	<ul style="list-style-type: none"> <li>• Der Speicher für Statistik oder Totalisation ist voll (mehr als 999 Ergebnisse)</li> </ul>	<ul style="list-style-type: none"> <li>• Neue "Statistik" oder "Totalisierung" Applikation starten.</li> </ul>

Störung / Anzeige	Mögliche Ursache	Massnahme
-Load/Unload Weight -	<ul style="list-style-type: none"><li>• Auf der Waagschale ist keine oder die gleiche Probe.</li></ul>	<ul style="list-style-type: none"><li>• Neue Probe oder bestehende Probe wegnehmen und wieder auf die Waagschale legen.</li></ul>
Unit change not allowed!	<ul style="list-style-type: none"><li>• Ändernder Einheit während einer "Statistik" oder "Totalisierung" Applikation.</li></ul>	<ul style="list-style-type: none"><li>• Waage Rückstellen (Reset)</li><li>• Einheit wieder zurückstellen</li></ul>
-- Out of range --	<ul style="list-style-type: none"><li>• Gewichtder Probe ist ausserhalb des erlaubten Wertes.</li></ul>	<ul style="list-style-type: none"><li>• Das Gewicht der Probe muss im Bereich von 70% - 130% des aktuellen Mittelwertes liegen.</li></ul>

## 8 Empfohlene Einstellungen und Druckermodelle

Angegeschlossenes Gerät	Einstellungen am angeschlossenen Gerät	Druckereinstellungen
DV, AV, PA, AR, AX, PX, SP, TA, NV, NVL, NVT, MB35/45, MB23/25, MB90/120 (T31P, T51P, T71P, T32XW, T32WE, T51 XW, T71XW, CKW)*	Drucker Modus Baud rate: 9600 Bit / Parity: 8 bit None 1 Handshake: Xon/Xoff	Werkseinstellung
EX	Drucker Modus Baud rate: 9600 Bit/Parität: 8 bit None 1 Handshake: Xon/Xoff	Werkseinstellung
Russisch	Drucker Modus Baud rate: 9600 Bit/Parität: 8 bit None 1 Handshake: Xon/Xoff Sprache: ANSI/WIN Russian	CP1251 Windows Cyrillic
Polnisch	Drucker Modus Baud rate: 9600 Bit/Parität: 8 bit None 1 Handshake: Xon/Xoff Sprache: ANSI/WIN Polish	CP852 MS-DOS Latin2
Tschechisch	Drucker Modus Baud rate: 9600 Bit/Parität: 8 bit None 1 Handshake: Xon/Xoff Sprache: ANSI/WIN Czech	CP852 MS-DOS Latin2
Ungarisch	Drucker Modus Baud rate: 9600 Bit/Parität: 8 bit None 1 Handshake: Xon/Xoff Sprache: ANSI/WIN Hungarian	CP852 MS-DOS Latin2
Portugiesisch	Drucker Modus Baud rate: 9600 Bit/Parität: 8 bit None 1 Handshake: Xon/Xoff Sprache: ANSI/WIN Portuguese	CP860 MS-DOS Portuguese
Englisch, Französisch, Deutsch, Italienisch, Spanisch, Chinesisch, Japanisch, Koreanisch	Drucker Modus Baud rate: 9600 Bit/Parität: 8 bit None 1 Handshake: Xon/Xoff	Werkseinstellung

**Hinweis:** \* Die Statistik und Summieren Funktionen des Druckers sind in den folgenden Modellen unterstützt: DV, EX, AV, PA, NV, MB23/25, AX, PX.  
Nur Druckfunktion ist in allen Modellen unterstützt.



### 9 Verbrauchsmaterial und Ersatzteile

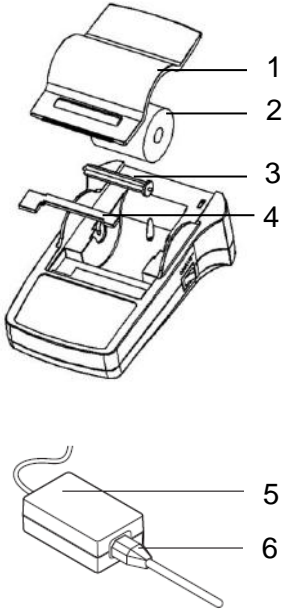

Pos	Item	Part Number	Delivery Quantity
1	Papierhaube	12120734	1 Stück
2	Papierrolle	12120799	1 Stück
3	Papierrolle-Achse	30063920	1 Stück
4	Farbbandkassette, schwarz	30529322	1 Stück
5	AC/DC Netzadapter (ohne Netzkabel) 100 - 240 VAC, 50 - 60 Hz, 12 VDC 2.5 A	30529321	1 Stück
6	Netzkabel CH	30064089	1 Stück
	Netzkabel EU	12120761	1 Stück
	Netzkabel US	12120762	1 Stück
	Netzkabel IT	30064200	1 Stück
	Netzkabel GB	12120312	1 Stück
	Netzkabel AU	12120313	1 Stück
	Netzkabel BR	83033772	1 Stück
	Netzkabel JP	12122638	1 Stück
-	RS9 M/F Kable, 1.5 m	30529323	1 Stück

### 10 RS232C-Schnittstelle

SF40-A Drucker besitzt für den Anschluss von OHAUS-Geräten eine RS232C-Schnittstelle.

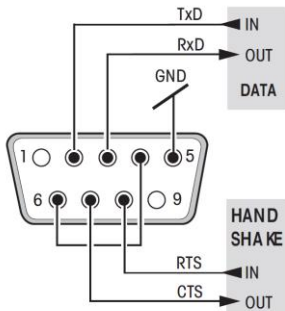

- 9-poliger männlicher Stecker
- Anpassung ans andere Gerät (Übertragungsparameter) siehe Kapitel 8.

## 11 Technische Daten

Stromversorgung	AC/DCNetzadapter: 12 VDC, 2.5 A Primär: 100 - 240 VAC, 50 - 60Hz Spannungsschwankungen: bis zu $\pm 10\%$ der Nennspannung Sekundär: 12 VDC, 2.5 A (elektronisch gegen Überlast)
Kabel zum Netzadapter	3-polig, mit länderspezifischem Stecker
Netzspannung	12 VDC
Stromaufnahme	Max. 2.5 A
Höhe über NN	Biz 2000 m
Umgebungstemperatur	0 °C – 40 °C
Relative Luftfeuchtigkeit	Max. 80% bei 31 °C, linear abnehmend bis 50% bei 40 °C, nicht kondensierend
Überspannungskategorie	Klasse II
Verschmutzungsgrad	2
Druckwerktyp	Nadel+Matrixdruckerr 5x7, 24 Zeichen pro Zeilenlänge
Druckgeschwindigkeit	1.2 Zeilen pro Sekunde
Farbbandkassette	Auswechselbar, Schwarz
Papierrolle	Normalpapier 57.5 mm x $\varnothing$ 50 biz 60 mm, in Gehäuse integriert, handelsüblich
Druckqualität	Druck lichteht und thermisch (GLP, GMP, ISO9001)
Schnittstelle	RS232C
Abmessungen Drucker	(BxTxH) 120 mm x 203 mm x 73 mm
Abmessungen Verpackung	(BxTxH) 255 mm x 205 mm x 150 mm
Nettogewicht	740 g (inkl. Papierrolle)
Kompatibilitätseinschränkungen	<ul style="list-style-type: none"> <li>•Funktion Datum / Zeit: Nicht anwendbar bei Waagen mit eingebauter Uhr (eingebaute Uhr hat vorrang)</li> <li>•Funktion Nullstellen / Trieren der Waage, Statistik und Totalisierung: Nicht bei allen Waagen anwendbar</li> </ul>

# ***Indice***

<b>Panoramica.....</b>	<b>1</b>
<b>1 Introduzione.....</b>	<b>2</b>
1.1 Descrizione.....	2
1.2 Caratteristiche.....	2
1.3 Contenuto della confezione.....	2
<b>2 Installazione.....</b>	<b>3</b>
2.1 Misure di sicurezza.....	3
2.2 Alimentazione.....	3
2.3 Impostazione stampante.....	4
2.3.1 Impostare la stampante usando il software abbinato.....	4
2.3.2 Impostare la stampante usando solo la stampante.....	8
2.4 Installazione della stampante.....	9
2.4.1 Collegare la stampante allo strumento.....	9
2.4.2 Accendere la stampante.....	9
2.4.3 Inserire la carta.....	9
<b>3 Funzioni dei tasti.....</b>	<b>10</b>
<b>4 Menu.....</b>	<b>11</b>
4.1 Menu.....	11
4.2 esempio di stampa.....	12
4.3 applicazioni.....	13
<b>5 Test della stampante.....</b>	<b>14</b>
<b>6 Manutenzione.....</b>	<b>14</b>
6.1 Cambiare il rotolo di carta.....	14
6.2 Sostituire il nastro inchiostro.....	14
6.3 Pulizia.....	15
6.4 Smaltimento.....	15
<b>7 Risoluzione dei problemi.....</b>	<b>16</b>

<b>8</b>	<b>Impostazioni consigliate.....</b>	<b>18</b>
<b>9</b>	<b>Consumi e parti di ricambio.....</b>	<b>19</b>
<b>10</b>	<b>Interfaccia RS232C.....</b>	<b>19</b>
<b>11</b>	<b>Dati tecnici.....</b>	<b>20</b>

## Panoramica

### Comandi



### Connessioni



- 1 Interruttore On/Off (I/O)
- 2 Spia/indicatore di stato
- 3 Pannello di controllo
- 4 Connessione di alimentazione
- 5 Connessione interfaccia

### Pannello di controllo



### Funzioni

Tasto	SF40A
	<ul style="list-style-type: none"> <li>• Azzerare/Tarare la bilancia</li> <li>• Annulla - Esci</li> </ul>
	<ul style="list-style-type: none"> <li>• Stampa di data e ora</li> <li>• Opzione scorrimento verso il basso del menu</li> </ul>
	<ul style="list-style-type: none"> <li>• Alimentazione carta</li> <li>• Opzione scorrimento verso l'alto del menu</li> </ul>
	<ul style="list-style-type: none"> <li>• Stampa dei valori di peso stabile</li> <li>• Aprire il menu               <ul style="list-style-type: none"> <li>- selezionare l'opzione successiva nel menu</li> </ul> </li> <li>• Salvare le impostazioni</li> </ul>
	<ul style="list-style-type: none"> <li>• Applicazione sommatoria</li> </ul>
	<ul style="list-style-type: none"> <li>• Applicazione statistiche</li> </ul>

## 1 Introduzione

### 1.1 Descrizione

La SF40A è una stampante ad aghi dot-matrix avanzata per strumenti OHAUS. La stampante ha le funzioni statistica e totalizzazione. La SF40A soddisfa, inoltre, i requisiti dei moderni sistemi di assicurazione della qualità come (GLP, GMP, ISO9001 ecc.).

### 1.2 Caratteristiche

- Supporta tutte le 13 lingue presenti negli strumenti Ohaus.
- Funzione statistica e totalizzazione.
- Funzione Azzeramento Tara.
- Funzione Orologio in tempo reale.
- Le stampe soddisfano i requisiti dei moderni sistemi di assicurazione della qualità come (GLP, GMP, ISO9001 ecc.).
- È conforme ai requisiti di tracciabilità della misurazione, documentando con precisione l'origine dei dati e le procedure di calibrazione.
- Soddisfa i requisiti di archiviazione dei risultati della misurazione, fornendo una stampa termicamente stabile, leggera e resistente.
- Permette un'installazione semplificata utilizzando il software fornito con la stampante.

### 1.3 Contenuto della confezione

- Stampante
- Alimentatore
- Scheda di garanzia
- Cavo RS232
- Manuale di istruzioni
- Rotolo di carta
- Cavo adattatore
- Asse di rotazione per il rotolo di carta
- Cavo di alimentazione\*

Nota:

\* America / US version: 1 pezzo (USA),  
UE / Regno Unito versione: 2 pezzi (EU + UK).

## 2 Installazione

### 2.1 Misure di sicurezza

La stampante è stata testata per le connessioni e gli scopi documentati nel presente manuale d'istruzioni d'uso. Questo non esonera l'utente dalla responsabilità di eseguire i propri test sul prodotto da noi fornito, per verificare la sua idoneità in relazione ai metodi e agli scopi che intende impiegare. Dovranno comunque essere osservate le seguenti misure di sicurezza:



- La stampante deve essere sempre usata al coperto e mai in aree a rischio.
- Le parti elettroniche della stampante sono protette contro polvere e schizzi d'acqua. Ciononostante, dato che la struttura della stampante non è a tenuta stagna, la stampante non dovrebbe essere usata in presenza di liquidi.
- Seguire le istruzioni per la pulizia (vedi capitolo 6.3), proteggere le prese dall'umidità.
- Non aprire mai la stampante. In caso di problemi, contattare il rivenditore OHAUS di fiducia.
- Se l'apparecchio viene utilizzato in un modo non specificato dal produttore, la protezione fornita dallo strumento può essere compromessa.

### 2.2 Alimentazione

La stampante è fornita con un alimentatore con un cavo di alimentazione specifico per paese. L'alimentatore è adatto a tutte le tensioni di linea del campo: 100 – 240 V CA, 50 – 60 Hz (per le specifiche esatte consultare la capitolo 11).

#### Attenzione



- In primo luogo controllare che la tensione di linea locale si collochi nel campo 100 – 240 V CA, 50 – 60 Hz e che la presa sia idonea al collegamento dell'alimentazione elettrica locale. In caso contrario non collegare per nessun motivo la stampante o l'alimentatore alla corrente e contattare il rivenditore OHAUS responsabile.
- Collegare l'alimentatore soltanto a una presa con messa a terra.

## Importante



- Prima dell'azionamento, controllare che i cavi non siano danneggiati.
- Collocare i cavi in modo che non si danneggino o interferiscano con il processo di pesata!
- Assicurarsi che l'alimentatore non entri in contatto con liquidi!
- La spina di alimentazione deve essere sempre accessibile.

## 2.3 Impostazione stampante

L'impostazione predefinita della stampante è quella che segue.

Header:	No Header	Baud rate:	9600
Date Format:	DD.MMM YYYY	Data bits:	8
Time Format:	24.MM:SS	Parity:	None
Char Set:	CP1252 Window Latin1	Stop bits:	1
Balance Feature:	Balance Feature Enable	Flow control:	Xon/Xoff
O/T Settings:	Perform Zero		

Vi sono due modi per modificare le impostazioni predefinite:

- Utilizzare il software OHAUS "ScaleMate".
- Lavorare esclusivamente sulla stampante.

### 2.3.1 Impostazione della stampante usando il software OHAUS ScaleMate

- 1) Usate il cavo (Kit di interfaccia RS232-USB, 30304101) e l'adattatore del cavo in dotazione per collegare il computer e la stampante.
- 2) Collegare la stampante all'alimentazione principale.
- 3) Usate l'interruttore principale <I/O> per accendere.
- 4) Installare il software ScaleMate di OHAUS (contattate il vostro rivenditore locale OHAUS per il software)



- 5) Esecutare il software, cliccare su "Cancel", quindi scegliere "SF-40A Printer" e cliccare su "Enter".

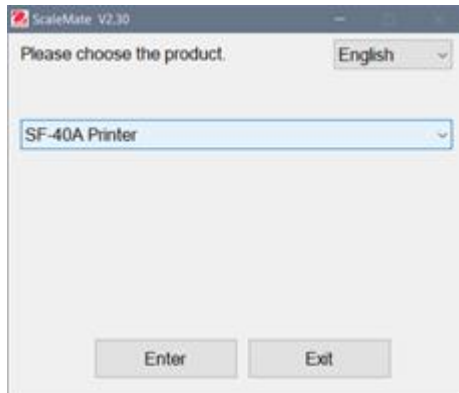

- 6) Configurare l'impostazione della porta COM del computer, quindi fare clic sul pulsante "Connect". La seguente finestra apparirà se la connessione ha successo, clicca su OK per continuare.

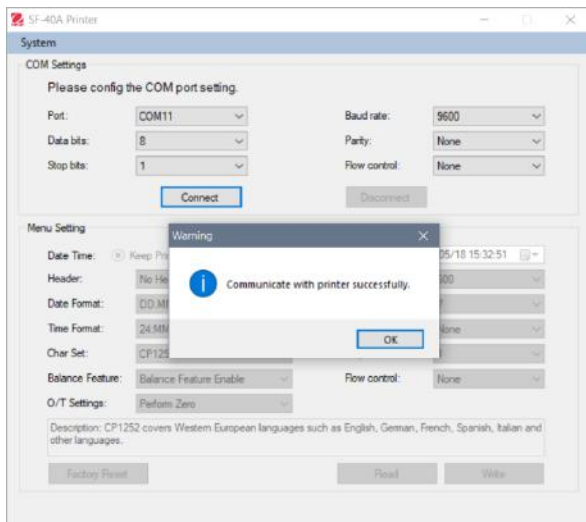

- 7) L'impostazione del menu della stampante è ora attivata e tutte le impostazioni possono essere cambiate.

Menu Setting

Date Time:  Keep Printer Time  Current System Time  Custom 2021/05/18 05:33:06

Header:  Baud rate:

Date Format:  Data bits:

Time Format:  Parity:

Char Set:  Stop bits:

Balance Feature:  Flow control:

O/T Settings:

Description: CP1252 covers Western European languages such as English, German, French, Spanish, Italian and other languages.

Factory Reset Read Write

- a. **Date Time (Data e ora):** regola la data e l'ora della stampante
- Keep Printer Time (Conserva ora stampante): conserva la data e l'ora impostate nella stampante
  - Current System Time (Ora attuale sistema): accetta la data e l'ora impostate sul computer
  - Custom (Personalizzata): regola la data e l'ora manualmente
- Nota:** Data e ora della bilancia hanno la priorità quando:
- la bilancia a la funzione data/ora integrata
  - la funzione bilancia sulla SF40A non é abilitata
- b. **Header (Intestazione):** Imposta l'intestazione dei contenuti della stampa
- No header (Nessuna intestazione): nessuna intestazione per i contenuti della stampa
  - Date/Time (Data/Ora): intestazione con data e ora
  - Date/Time/Balance (Data/Ora/Bilancia): intestazione con data, ora e S/N (numero di matricola).
- c. **Date Format (Formato data):** imposta il formato della data
- d. **Time Format (Formato ora):** imposta il formato dell'ora
- e. **Char Set (Codifica caratteri):** imposta la pagina di codici per ogni lingua

- CP 1252 Window Latin1: viene utilizzato per le lingue dell'Europa occidentale come inglese, tedesco, francese, spagnolo e italiano.
- CP 1251 Window Cyrillic: viene utilizzato per le lingue con alfabeto cirillico, come il russo, il bulgaro e il cirillico serbo.
- CP437 MS-DOS Latin US: viene utilizzato per le lingue dell'Europa occidentale come inglese, tedesco, francese, spagnolo e italiano.
- CP852 MS-DOS Latin2: viene utilizzato per le lingue dell'Europa centrale con caratteri latini, come polacco, bosniaco, ceco, ungherese, croato, rumeno, serbo e slovacco.
- CP860 MS-DOS Portuguese: Covers Portuguese language

**Nota:** SF40A supporta cinese, coreano e giapponese indipendentemente dal codice carattere.

**f. Balance Feature (Funzione Bilancia):**

1) Abilita/disabilita la funzione della stampante: 0/T, Statistics, Totalization (Azzeramento/Tara, Statistica/Totalizzazione)

2) Printer connection status (Stato di connessione stampante): La spia lampeggia o si accende fisso.

- Balance Feature Enabled (Funzione Bilancia abilitata): Le funzioni Azzeramento/Tara, statistica e totalizzazione della stampante sono abilitate. La spia/indicatore di stato della stampante lampeggia se si perde la connessione con la bilancia.
- Balance Feature Disable (Funzione Bilancia disabilitata): Le funzioni Azzeramento/Tara, statistica e totalizzazione della stampante sono disabilitate. La spia/indicatore di stato della stampante resta acceso fisso anche se si perde la connessione con la bilancia.

**g. 0/T Setting (Impostazioni Azzeramento/Tara):** imposta il funzionamento del pulsante 0/T

- Perform Zero (Esegui azzeramento): Premendo il pulsante viene eseguito l'azzeramento.
- Perform Tare (Esegui tara): Premendo il pulsante viene eseguita la tara.

**h. Baud rate, Data bits, Parity, Stop bits, Flow control (Baud rate, bit di dati, parità, bit di stop, controllo di flusso):** imposta i parametri dell'impostazione RS232.

Le impostazioni devono essere identiche a quelle definite per lo strumento in uso. Per le impostazioni RS232 sullo strumento, vedere il manuale dello strumento.

Factory Reset

Reimposta la stampante sui valori di fabbrica predefiniti.

- Velocità di trasmissione: 9600
- Bit di dati: 8
- Parità: nessuna
- Bit di stop: 1
- Controllo del flusso: Xon / Xoff

Read

Accetta le impostazioni correnti della stampante.

Write

Salva le impostazioni sulla stampante.

8) Cliccare il pulsante "Write" per salvare l'impostazione nella stampante.

### 2.3.2 Impostare la stampante usando solo la stampante

- 1) Collegare la stampante all'alimentazione principale.
- 2) Utilizzare l'interruttore principale <I/O> per accendere la stampante.
- 3) Tenere premuto il pulsante «  » per entrare nel menu, la stampante eseguirà la stampa

“-----Menu-----“.

Premere «  » per scegliere le voci da modificare.

Premere «  » per modificare il parametro.

Tenere premuto «  » per salvare e uscire.

Premere «  » per uscire senza salvare

I contenuti saranno stampati per mostrare il risultato di ogni operazione.

Per la struttura completa del menu, vedere il capitolo 4.

Per controllare il numero di versione della stampante SF40A usa



l'interruttore principale <I/O> mentre si pressiona il bottone «  ». Quando la stampante inizia a stampare, rilasciare il bottone.

## 2.4 Installazione della stampante

La stampante rileva le impostazioni dello strumento. Assicurarsi di procedere come indicato:

### 2.4.1 Collegare la stampante allo strumento

- Collegare il cavo RS232 e l'adattatore all'interfaccia presente sullo strumento e sulla stampante
- Accendere lo strumento.

### 2.4.2 Accendere la stampante







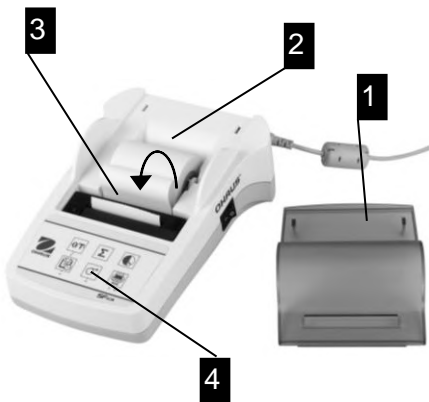









- Collegare la stampante alla corrente elettrica.
- Utilizzare l'interruttore On/Off (I/O) per accendere la stampante
- Solo per l'interfaccia RS232: la spia lampeggia finché non viene collegato uno strumento. Se la spia continua a lampeggiare controllare al capitolo 7.

### 2.4.3 Inserire della carta

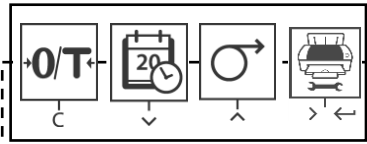

- Togliere il coperchio (tirando la parte posteriore) (1).
- Inserire l'asse di rotazione del rotolo di carta nel centro del nuovo rotolo (2).
- Inserire la carta nell'apposita apertura in direzione della freccia (3).
- Tenere premuto il pulsante fino a la lunghezza desiderata della carta (4).
- Infilare la carta attraverso il coperchio.
- Riporre il coperchio (1).

### 3 Funzioni dei tasti

	 Premere brevemente	 Premere e mantenere
<b>Livello operativo</b>	 azzeramento / tara della bilancia  stampa data/ora  una riga di alimentazione  stampa dei valori	 avanza continuamente (fino al rilascio del pulsante)  apri il menu
<b>Livello menu</b>	 <p>esci    giù    su    avanti</p>	 Salva le impostazioni
<b>Livello applicazione</b>	 Avvio dell'applicazione totalizzazione  Avvio dell'applicazione statistica	 Chiusura dell'applicazione totalizzazione  Chiusura dell'applicazione statistica

# 4 Menu

## 4.1 Menu

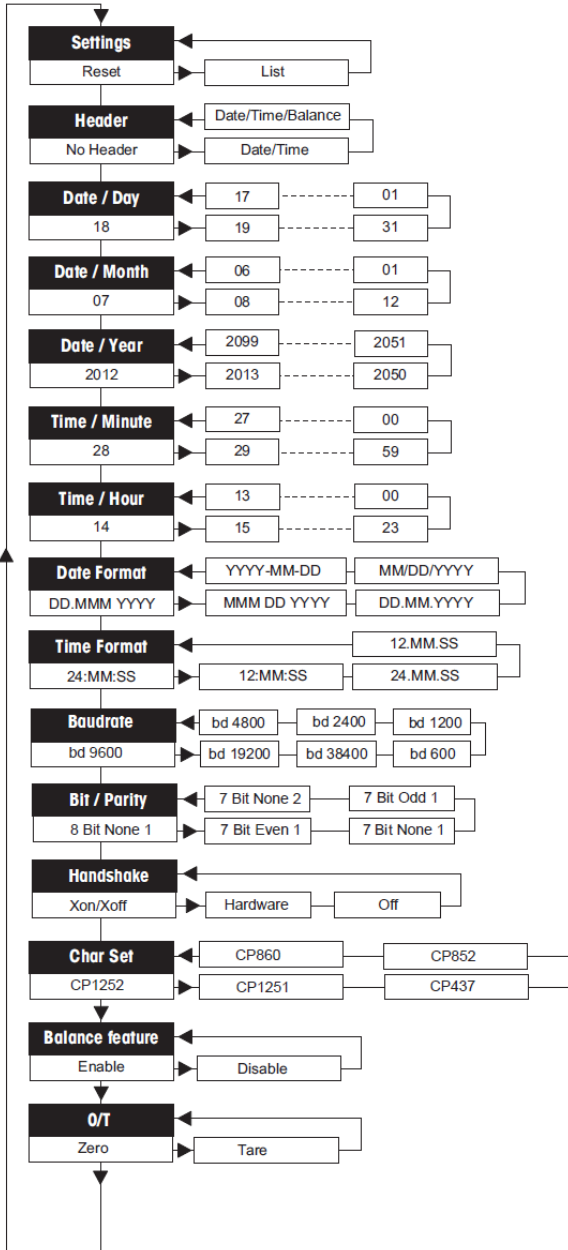























## 4.2 Esempio di stampa

```
-----MENU-----  
  
Impostazioni:  
  * List  
  
Testata:  
  * No Header  
  
Giorno:  
  31  
  
Mese:  
  07  
  
Anno:  
  2012  
  
Minuti:  
  00  
  
Ora:  
  18
```

\* impostazioni di fabbrica



## 4.3 Applicazioni

 Premere brevemente		 Premere e mantenere premuto	
<b>Applicazione Statistica</b>  	→ Avviare l'applicazione statistica (LED acceso).	<b>Applicazione Totalizzazione</b>  	→ Avviare l'applicazione totalizzazione " (LED acceso).
 	→ Aggiungere un nuovo campione e premere «  »	 	→ Aggiungere un nuovo campione e premere «  »
 	→ Se è necessario stampare un totale parziale premere il pulsante «  »	 	→ Se è necessario stampare un totale parziale premere il pulsante «  »
 	→ Stampare e terminare l'applicazione statistica (LED spento).	 	→ Stampare e terminare l'applicazione totalizzazione (LED spento).

**Note importanti**

• Non è permesso cambiare l'unità di misura durante l'applicazione.

- 1) Si possono salvare un massimo di 999 campioni in entrambe le applicazioni.
- 2) Pesi campione minime devono essere più grandi di 1d.
- 3) Durante il cambio di esempio, la lettura della scala deve essere cambiato da più di 100d, altrimenti la stampante non registrerà il cambiamento campione.

- 4) L'applicazione statistica include: numero di campioni, valore medio, deviazione standard, min, max, differenza min-max e il peso totale.

## 5 Test della stampante

La stampante è dotata di un test automatico che stampa il set di caratteri della stampante (stan-dard IBM/DOS).

### Avviare il test

- Premere il tasto «  » e accendere la stampante. La stampante stampa il set di caratteri.

### Terminare il test

- Spegnere la stampante.

## 6 Manutenzione

In condizioni normali la stampante praticamente non richiede manutenzione. Il servizio di assistenza OHAUS è comunque disponibile in caso di necessità. Contattare il rivenditore autorizzato OHAUS per informazioni.

### 6.1 Cambiare il rotolo di carta

L'inserimento di un nuovo rotolo di carta è descritto alla capitolo 2.4. Il numero d'ordine per il rotolo di carta è al capitolo 9 materiali.

Nota: Potete utilizzare lo stesso asse di rotazione.

### 6.2 Sostituire il nastro inchiostro



- Rimuovere il coperchio (1).
- Estrarre la carta dall'unità di stampa (2).



- Estrarre il vecchio nastro, premendo in direzione della freccia (3).
- Inserire il nuovo nastro e, se necessario, allentarlo con la rotella di tensionamento (4). Per il codice d'ordine del nastro vedere capitolo 9 materiali
- L'inserimento di un nuovo rotolo carta è descritto alla capitolo 2.4.

### 6.3 Pulizia

Lo chassis è realizzato in materiale di alta qualità, si possono perciò utilizzare tutti i detergenti non aggressivi in commercio (vedi misure di capitolo 2.1).

### 6.4 Smaltimento



In conformità a quanto stabilito dalla Direttiva Europea 2002/96/CE in materia di apparecchi elettrici ed elettronici (RAEE), questo strumento non può essere smaltito come i normali rifiuti. Tale pre-supposto resta valido anche per i Paesi al di fuori dei confini della UE, conformemente alle norme nazionali in vigore. Si prega quindi di smaltire questo prodotto separatamente e in modo specifico secondo le disposizioni locali relative alle apparecchiature elettriche ed elettroniche. Per qualsiasi chiarimento, rivolgersi agli enti preposti o al rivenditore dell'apparecchiatura stessa. In caso di cessione dello strumento (per es. per ulteriore utilizzo privato o aziendale/industriale), si prega di comunicare anche questa disposizione. Si ringrazia per il contributo alla tutela dell'ambiente.

## 7 Risoluzione dei problemi

Malfunzionamento/ messaggio	Possibile causa	Intervento
Stampa illeggibile	<ul style="list-style-type: none"> <li>Nastro usurato o inceppato.</li> <li>Fine della durata dell'unità di stampa.</li> </ul>	<ul style="list-style-type: none"> <li>Cambiare la cartuccia a nastro o tendere il nastro.</li> <li>Contattare l'assistenza OHAUS.</li> </ul>
La spia di accensione non si accende	<ul style="list-style-type: none"> <li>Assenza di alimentazione.</li> <li>Guasto all'alimentazione.</li> </ul>	<ul style="list-style-type: none"> <li>Accendere la stampante.</li> <li>Contattare l'assistenza OHAUS.</li> </ul>
La spia di accensione lampeggia	<ul style="list-style-type: none"> <li>Nessun dispositivo collegato alla stampante.</li> <li>La stampante non ha trovato le impostazioni dello strumento collegato.</li> </ul>	<ul style="list-style-type: none"> <li>Assicurarsi che la stampante e lo strumento siano collegati.</li> <li>Spegnere e riaccendere la stampante.</li> <li>Cambiare alternativamente le impostazioni della stampante o dello strumento collegato. (vedere capitolo 8)</li> </ul>
-----Timeout -----	<ul style="list-style-type: none"> <li>Il trasferimento dati non è stato completato negli ultimi 45 s.</li> </ul>	<ul style="list-style-type: none"> <li>Spostare la bilancia in una posizione più stabile.</li> <li>Controllare la bilancia.</li> </ul>
----- Over Load -----	<ul style="list-style-type: none"> <li>La bilancia è in sovraccarico.</li> </ul>	<ul style="list-style-type: none"> <li>Controllare il peso del campione</li> </ul>
	<ul style="list-style-type: none"> <li>Azzeramento del campo zero</li> </ul>	<ul style="list-style-type: none"> <li>Modificare il campo zero della bilancia.</li> <li>Modificare l'impostazione della stampante dallo zero al valore della tara.</li> </ul>
----- Under Load ----	<ul style="list-style-type: none"> <li>La bilancia è in sottocarico. Il piatto della bilancia non è in posizione corretta</li> </ul>	<ul style="list-style-type: none"> <li>Controllare la bilancia.</li> </ul>
--Transmission Error--	<ul style="list-style-type: none"> <li>Lo strumento non comprende le istruzioni della stampante.</li> </ul>	<ul style="list-style-type: none"> <li>Verificare le impostazioni dei parametri dell'interfaccia sulla stampante e sullo strumento.</li> </ul>
-- Not Executable ---	<ul style="list-style-type: none"> <li>Lo strumento non può eseguire le istruzioni della stampante.</li> </ul>	<ul style="list-style-type: none"> <li>Verificare lo strumento</li> </ul>
--Date/Time Not Set -- ---- Memory Error ----	<ul style="list-style-type: none"> <li>Messaggi di errore di stampa.</li> </ul>	<ul style="list-style-type: none"> <li>Verificare lo strumento</li> <li>Resettare la stampante.</li> <li>Impostare data/ora.</li> <li>Batteria di back-up esaurita</li> <li>Contattare l'assistenza OHAUS.</li> </ul>
----- Memory full -----	<ul style="list-style-type: none"> <li>La memoria delle applicazioni statistica e totalizzazione è piena (più di 999 campioni)</li> </ul>	<ul style="list-style-type: none"> <li>Avviare una nuova applicazione Statistica o Somma.</li> </ul>

Malfunzionamento/ messaggio	Possibile causa	Intervento
-Load/Unload Weight -	<ul style="list-style-type: none"><li>• Nessun campione o lo stesso campione è presente sul piatto della bilancia.</li></ul>	<ul style="list-style-type: none"><li>• Posizionare un nuovo campione o rimuoverlo e riposizionarlo sul piatto.</li></ul>
Unit change not allowed!	<ul style="list-style-type: none"><li>• Si è verificato un cambio di unità di misura durante un'applicazione Statistica o Somma.</li></ul>	<ul style="list-style-type: none"><li>• Resetare la bilancia.</li><li>• Ripristinare l'unità di misura precedente</li></ul>
-- Out of range - -	<ul style="list-style-type: none"><li>• Il peso del campione è fuori gamma</li></ul>	<ul style="list-style-type: none"><li>• Il peso del campione deve essere compreso nella gamma 70% - 130% del valore medio attuale.</li></ul>

## 8 Impostazioni consigliate e modelli della stampante

Dispositivo collegato	Impostazioni dispositivo	Impostazioni stampante
DV, AV, PA, AR, AX, PX, SP, TA, NV, NVL, NVT, MB35/45, MB23/25, MB90/120 (T31P, T51P, T71P, T32XW, T32WE, T51 XW, T71XW, CKW)*	Modalità stampa Baud rate: 9600 Bit / Parity: 8 bit None 1 Handshake: Xon/Xoff	Impostazioni di fabbrica
EX	Modalità stampa Baud rate: 9600 Bit/Parität: 8 bit None 1 Handshake: Xon/Xoff	Impostazioni di fabbrica
ruso	Modalità stampa Baud rate: 9600 Bit/Parität: 8 bit None 1 Handshake: Xon/Xoff Lingua: ANSI/WIN russo	CP1251 Windows Cyrillic
polaco	Modalità stampa Baud rate: 9600 Bit/Parität: 8 bit None 1 Handshake: Xon/Xoff Lingua: ANSI/WIN polaco	CP852 MS-DOS Latin2
checo	Modalità stampa Baud rate: 9600 Bit/Parität: 8 bit None 1 Handshake: Xon/Xoff Lingua: ANSI/WIN ceco	CP852 MS-DOS Latin2
húngaro	Modalità stampa Baud rate: 9600 Bit/Parität: 8 bit None 1 Handshake: Xon/Xoff Lingua: ANSI/WIN húngaro	CP852 MS-DOS Latin2
portugués	Modalità stampa Baud rate: 9600 Bit/Parität: 8 bit None 1 Handshake: Xon/Xoff Lingua: ANSI/WIN portugués	CP860 MS-DOS portugués
Inglés, francés, alemán, italiano, español, chino, japonés, coreano	Modalità stampa Baud rate: 9600 Bit/Parität: 8 bit None 1 Handshake: Xon/Xoff	Impostazioni di fabbrica

### Nota:

\* Le funzioni di Statistica e Totalizzazione della stampante sono supportati nei seguenti modelli: DV, EX, AV, PA, NV, MB23/25, AX, PX.

Funzione di solo stampa è supportata in tutti i modelli.

## 9 Materiali e pezzi di ricambio

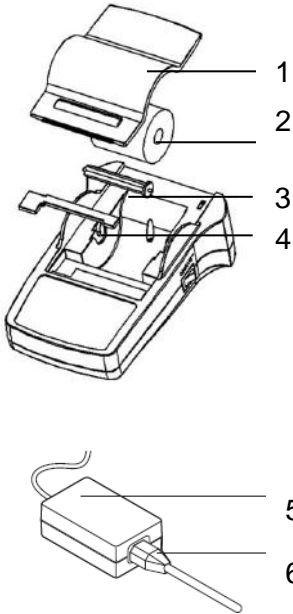

Pos.	Articolo	Codice	Consegna
1	Coperchio carta	30047939	1 pz
2	Rotolo di carta	12120799	1 pz
3	Asse di rotazione	30063920	1 pz
4	Nastro inchiostrato, nera	30529322	1 pz
5	Alimentatore CA/CC (senza cavo di alimentazione) 100 - 240 V CA, 50 - 60 Hz, 12 V CC 2.5 A	30529321	1 pz
6	Cavo di alimentazione CH Cavo di alimentazione EU Cavo di alimentazione US Cavo di alimentazione IT Cavo di alimentazione GB Cavo di alimentazione AU Cavo di alimentazione BR Cavo di alimentazione JP	30064089 12120761 12120762 30064200 12120312 12120313 83033772 12122638	1 pz 1 pz 1 pz 1 pz 1 pz 1 pz 1 pz 1 pz
-	RS9 M/F cavo, 1.5 m	30529323	1 pz

## 10 Interfaccia RS232C

La stampante SF40-A dotata di interfaccia RS232C per il collegamento con altri strumenti OHAUS.

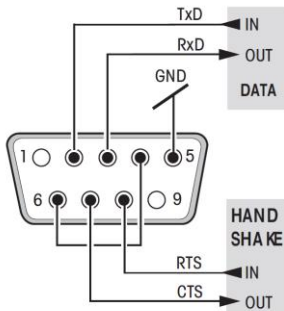

- Connettore maschio a 9-pin
- Per la corrispondenza con altri strumenti (parametri di trasmissione) vedere capitolo 8.

## 11 Dati tecnici

Alimentazione	Adattatore CA/CC: 12 V CC, 2.5 A Tensione di entrata: 100 – 240 V CA, 50 – 60 Hz Fluttuazioni di tensione: fino a $\pm 10\%$ della tensione nominale Tensione di uscita: 12 V CC, 2.5 A (con protezione da sovraccarico elettrico)
Cavo ad adattatore CA/CC	a 3 poli, con connettore secondo specifiche locali
Tensione di rete, frequenza	12 V CC
Consumo energetico	max. 2.5 A
Altitudine	fino a 2000 m
Temperatura ambiente	0 °C – 40 °C
Umidità relativa	max. 80% a 31 °C, decremento lineare a 50% a 40 °C, non condensante
Categoria di sovratensione	Classe II
Grado di inquinamento	2
Unità di stampa	Stampante a matrice di punti 5x7, lunghezza riga 24 caratteri
Velocità di stampa	1.2 righe al secondo
Nastro inchiostro	Sostituibile, nera
Rotolo di carta	Carta normale da 57.5 mm x $\varnothing$ 50 a 60 mm, incorporato nell'alloggiamento, dimensioni commerciali
Qualità di stampa	Stampa resistente alla luce e termicamente stabile (GLP, GMP, ISO 9001)
Interfaccia:	RS232C
Ingombro stampante	(LxPxA) 120 mm x 203 mm x 73 mm
Ingombro imballo	(LxPxA) 255 mm x 205 mm x 150 mm
Peso netto	740 g (con rotolo de papel)
Limitazione della compatibilità	<ul style="list-style-type: none"> <li>• Funzione per data e ora: non applicabile su le bilance con orologio integrato (l'orologio integrato ha la priorità)</li> <li>• Funzione per azzeramento/messain, estadísticas y totalización tara della bilancia: non applicabile per tutti i modelli</li> </ul>



# ÍNDICE

1	Introdução .....	2
1.1	Descrição .....	2
1.2	Recursos .....	2
1.3	Conteúdo da Embalagem .....	2
2	Procedimento de Inicialização .....	3
2.1	Medidas de Segurança .....	3
2.2	Alimentação .....	3
2.3	Configuração da Impressora .....	4
2.3.1	Configuração da impressora utilizando software fornecido ...	<b>Error!</b>
	<b>Bookmark not defined.</b>	
2.3.2	Configuração utilizando somente a impressora .....	7
2.4	Instalando a impressora .....	8
2.4.1	Conectando a impressora ao instrumento .....	8
2.4.2	Ativando a impressora .....	8
2.4.3	Inserindo papel .....	8
3	Funções de Teclas .....	9
4	Menu .....	12
4.1	Estrutura da árvore do menu .....	3
4.2	Exemplo de impressão .....	3
4.3	Aplicativos .....	4
5	Teste da Impressora .....	15
6	Manutenção .....	15
6.1	Trocando o Rolo de Papel .....	15
6.2	Substituindo a Fita .....	15
6.3	Limpeza .....	16
6.4	Descarte .....	16
7	Solução de Problemas .....	17
8	Configurações Recomendadas .....	19
9	Consumíveis e Peças Sobressalentes .....	20

10 Interface RS232C .....	20
11 Datos Técnicos .....	21

## Visão Geral

### Controles



### Conexões



- 1 Chave Liga / Desliga
- 2 Lâmpada piloto – indicador de condição
- 3 Painel de controle
- 4 Conexão de energia
- 5 Conector de interface

### Painel de controle

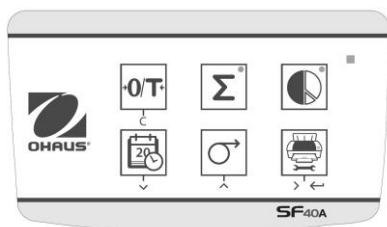

### Funções

Tecla	SF40A
	<ul style="list-style-type: none"> <li>Zerar/Tarar a balança</li> <li>Abortar-Sair</li> </ul>
	<ul style="list-style-type: none"> <li>Impressão de data e horário</li> <li>Opção de rolagem para baixo no menu</li> </ul>
	<ul style="list-style-type: none"> <li>Alimentação de papel</li> <li>Opção de rolagem para cima no menu</li> </ul>
	<ul style="list-style-type: none"> <li>Impressão de valores estáveis de pesos</li> <li>- Abrindo o menu - selecionar próxima opção do menu</li> <li>Salvar configurações</li> </ul>
	<ul style="list-style-type: none"> <li>Aplicação de totalização</li> </ul>
	<ul style="list-style-type: none"> <li>Aplicação de estatística</li> </ul>

# 1 Introdução

## 1.1 Descrição

A SF40A é uma impressora matricial avançada da OHAUS. A impressora possui funções de estatística e totalização. A SF40A também atende aos requisitos de modernos sistemas de garantia de qualidade como (GLP, GMP, ISO9001 etc.).

## 1.2 Recursos

- Suporta todos os 13 idiomas presentes nos instrumentos OHAUS.
- Funções de Estatística e Totalização.
- Função Zerar/Tarar.
- Função de relógio em tempo real.
- A impressão atende aos requisitos de modernos sistemas de garantia de qualidade (GLP, GMP, ISO9001, etc.)
- Cumpre os requisitos de rastreabilidade de medição documentando com precisão a origem dos dados, bem como procedimentos de calibração.
- Atende ao requisito de arquivo de resultados de medição oferecendo uma impressão térmica estável e resistente à luz.
- Fácil configuração com o software fornecido com a impressora.

## 1.3 Conteúdo da Embalagem

- Impressora
- Adaptador de Força
- Cartão de Garantia
- Cabo RS232
- Manual de Instruções
- Rolo de Papel
- Adaptador de Cabo
- Eixo Giratório de Papel
- Cabo de Força\*

**Nota:** \* Versão AM/US: 1 cabo, versão EU/UK: 2 cabos.

## 2. Procedimento de Inicialização

### 2.1 Medidas de Segurança

A Impressora foi testada em suas conexões e as finalidades pretendidas documentadas nestas Instruções Operacionais. Contudo, constitui sua responsabilidade realizar os testes necessários referentes aos métodos e finalidades de seu uso pretendido. Dessa forma, você deverá observar as seguintes medidas de segurança.



A impressora somente deverá ser utilizada internamente e jamais em áreas perigosas.

A parte eletrônica da impressora é protegida contra a entrada de respingos de água e pó. Contudo, considerando que o gabinete da impressora não é à prova d'água, a mesma não deverá ser utilizada na presença de líquidos. Observe as instruções de limpeza (ver capítulo 6.3), proteja o plugue de força contra condições de umidade.

Jamais abra o gabinete da impressora. Se tiver quaisquer problemas com a impressora, contate seu representante OHAUS.

Se o equipamento for utilizado de forma não especificada pelo fabricante, a proteção oferecida pelo equipamento poderá ser comprometida.

### 2.2 Alimentação

Sua impressora é alimentada com adaptador AC com cabo de força específico ao país. A alimentação de força é adequada a todas as voltagens na faixa: 100 – 240 VAC, 50 – 60 Hz (para especificações exatas, ver o capítulo 11).

#### Atenção



- Primeiramente, verifique se a voltagem de linha local está na faixa 100 – 240 VAC, 50 - 60 Hz e se o plugue de força encaixa-se na conexão de força local. **Se não for o caso, sob nenhuma circunstância conecte a impressora ou o adaptador AC à fonte de alimentação;** contate o representante OHAUS.
- **Somente conecte o adaptador em uma tomada que esteja aterrada.**

#### Importante



- Antes do funcionamento, verifique todos os cabos quanto a danos.
- Passe os cabos de forma que não se danifiquem nem interfiram com o processo de pesagem.
- Verifique se o adaptador AC não entra em contato com líquidos
- O plugue de força deverá sempre permanecer acessível.

## 2.3 Configuração da Impressora

A configuração padrão da impressora é a seguinte.

Header:	No Header	Baud rate:	9600
Date Format:	DD.MMM YYYY	Data bits:	8
Time Format:	24.MM:SS	Parity:	None
Char Set:	CP1252 Window Latin1	Stop bits:	1
Balance Feature:	Balance Feature Enable	Flow control:	Xon/Xoff
O/T Settings:	Perform Zero		

Há duas formas de alterar a configuração padrão:

- Use o software OHAUS "ScaleMate".
- Utilize somente na impressora.

### 2.3.1 Configuração da impressora usando o software OHAUS ScaleMate

- 1) Use o cabo (kit de interface RS232-USB, PN 30304101) e o adaptador de cabo que acompanha para conectar o computador e a impressora.
- 2) Conecte a impressora à fonte de alimentação principal.
- 3) Use o interruptor principal <I / O> para ligar.
- 4) Instale o software OHAUS ScaleMate (entre em contato com o revendedor OHAUS local para obter o software) seguir clique no botão "Connect"
- 5) Execute o software, clique em "Cancelar", escolha "Impressora SF-40A" e clique em ENTER

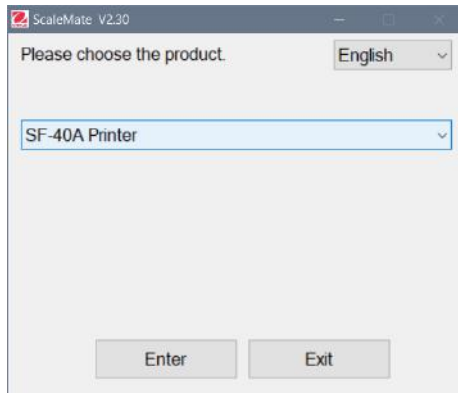
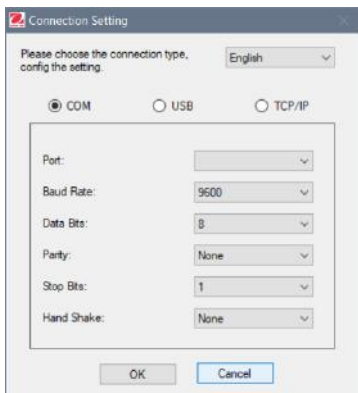

- 6) Configure a configuração da porta COM do computador e, a seguir, clique no botão “Conectar”. A janela a seguir aparecerá se a conexão for bem-sucedida, clique em OK para continuar.

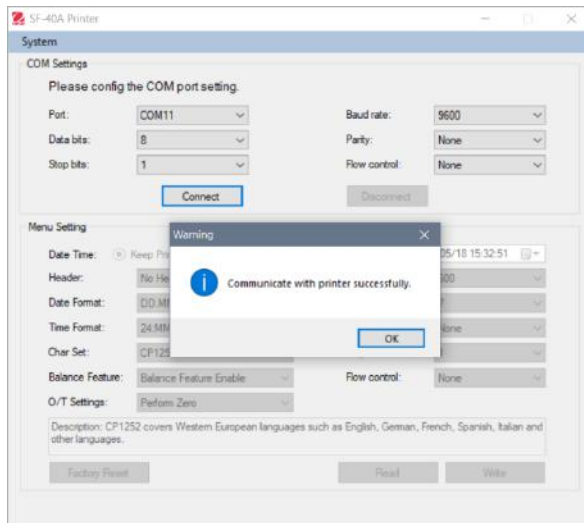

- 7) A configuração do menu da impressora agora está ativada e todas as configurações podem ser alteradas.



### Data e Horário: Configure a data e horário da impressora

- Keep Printer Time: mantenha a data e o horário existentes na impressora
- Current System Time: Obtenha a data e horário de seu computador
- Custom: Configure manualmente a data e horário

**Nota:** A data e hora da balança têm prioridade quando:

- A balança possui dados / hora integrados.
- O recurso da balança na SF40A está ativado.

**b. Header:** Configure o cabeçalho do conteúdo da impressão

- No header: Nenhum cabeçalho no conteúdo da impressão
- Date/Time: Cabeçalho com data e horário
- Date/Time/Balance: Cabeçalho com data, hora e número de série da balança

**c. Date Format:** Configure o formato de data

**d. Time Format:** Configure o Formato de Horário

**e. Char Set:** Configure a página Code para diferentes idiomas

- CP 1252 Window Latin1: Inclui idiomas europeus ocidentais como inglês, alemão, francês, espanhol e italiano.
- CP 1251 Window Cyrillic: Inclui idiomas que utilizam o alfabeto cirílico como russo, búlgaro e cirílico sérvio.
- CP437 MS-DOS Latin US: Inclui idiomas europeus ocidentais como inglês, alemão, francês, espanhol e italiano.
- CP852 MS-DOS Latin2: Inclui idiomas europeus centrais que utilizam o alfabeto latino como bósnio, polonês, checo, húngaro, croata, romeno, sérvio e eslovaco.
- CP860 MS-DOS Portuguese: Inclui o idioma português

**Nota:** SF40A oferece suporte chinês, coreano e japonês, independentemente do código de caractere.

**f. Recursos da Balança:**

- 1) Enable/Disable a function: 0/T, Estatística, Totalização
- 2) Printer connection status: Luz LED piscará ou permanecerá acesa.
  - Balance Feature Enabled: 0/T, funções Estatística e Totalização da impressora estão ativadas. A luz LED de conexão da impressora piscará se a conexão com a balança for perdida.
  - Balance Feature Disable: As funções 0/T, Estatística, Totalização da impressora estão desativadas. O LED de condição de conexão da impressora permanecerá aceso mesmo se a conexão com a balança for perdida.

**g. 0/T Setting:** Configure a função do botão 0/T



- Perform Zero: Executa função Zero quando pressionar o botão.
- Perform Tare: Executa função Tara quando pressionar o botão.

**h. Taxa baud, Data bits, Parity, Stop bits, Flow control:** Configura os parâmetros da configuração RS232.

As configurações deverão ser as mesmas quando o instrumento for conectado. Para as configurações RS232 do instrumento, favor consultar o manual do instrumento.

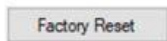

Redefina a impressora para a configuração padrão de fábrica.

- Taxa Baud: 9600
- Bits de dados: 8
- Paridade: Nenhuma
- bits de parada: 1
- Controle de fluxo: Xon / Xoff

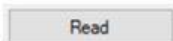

Obtém as configurações atuais da impressora. Salva as configurações na impressora.

- 8) Clique no botão 'Save Status' para salvar a configuração e clique em Exit para terminar a configuração.

**2.3.2 Configuração utilizando somente a impressora**

- 1) Conecte a impressora à fonte principal de alimentação.
- 2) Utilize a chave principal <I/O> para ativar.



- 3) Pressione e mantenha pressionado o botão « > | < » para entrar na lista do menu; a impressora irá imprimir "-----Menu-----".

Pressione «  » para selecionar o item a ser alterado.

Pressione «  » para alterar o parâmetro.

Pressione e mantenha pressionado «  » para salvar e sair.

Pressione «  » para sair sem salvar

A impressora irá imprimir o conteúdo mostrando o resultado de todas as operações.

Para estrutura total do menu, consultar o capítulo 4.

Para verificar o número da versão do SF40A, use o interruptor principal

<I / O> para ligar enquanto pressiona e segura o botão . Quando a

impressora começar a imprimir, solte o botão .

## 2.4 Instalando a impressora

### 2.4.1 Conectando a impressora ao instrumento

Antes de conectar, verifique se o equipamento e a impressora têm a mesma configuração do parâmetro RS232. Para as configurações da taxa Baud do instrumento, consultar o respectivo manual.

- Conecte o cabo de interconector à interface da impressora do instrumento e à impressora
- Ative o instrumento.

### 2.4.2 Ativando a impressora



- Conecte a impressora à fonte principal de alimentação.
- Utilize a chave principal <I/O> para ativar.
- Somente interface RS232: a lâmpada-piloto piscará até que o instrumento seja conectado. Se a lâmpada continuar a piscar, ver o capítulo 7.

### 2.4.3 Inserindo papel

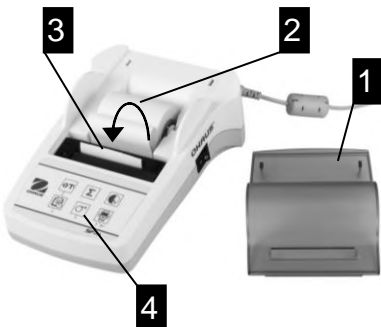

- Retire a tampa do papel (puxe a parte traseira) (1).
- Insira o eixo giratório do papel através do centro do rolo de papel (2).
- Passe o papel pela ranhura na unidade de impressão na direção da flecha (3).
- Pressione e mantenha pressionado até que papel suficiente tenha sido alimentado (4).
- Recoloque a tampa do papel (1).



# 4 Menu

## 4.1 Estrutura da organograma do menu

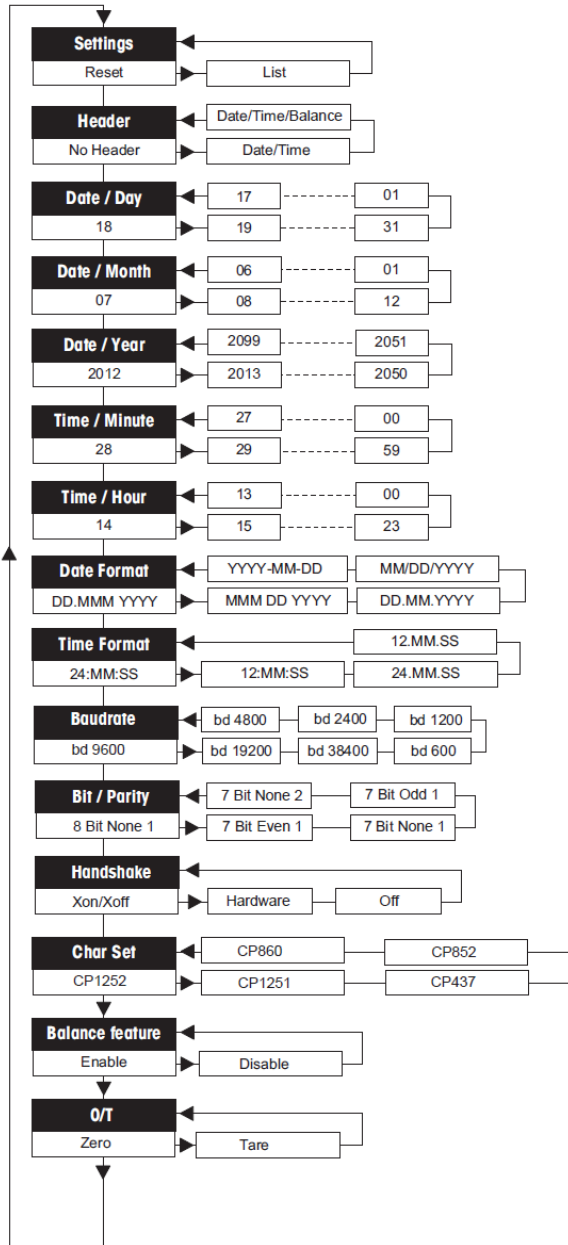

## 4.2 Exemplo de impressão:

```
-----MENU-----  
Settings:  
  * List  
  
Header:  
  * No Header  
  
Date Day:  
  31  
  
Date Month:  
  07  
  
Date Year:  
  2012  
  
Time Minute:  
  00  
  
Time Hour:  
  18  
  
Date Format:  
  * YYYY-MM-DD  
  
Time Format:  
  * 24:MM:SS  
  
Baudrate:  
  * 9600  
  
Bit/Parity:  
  * 8 Bit None 1  
  
Handshake:  
  * Xon/Xoff  
  
Char Set:  
  * CP1252 Windows Latin 1  
  
Balance Feature:  
  * Enable  
  
->0/T<- Setting:  
  * Zero
```

\* Configurações de fábrica

## 4.3 Aplicações

 Pressionar brevemente	 Pressionar e manter pressionado		
<p><b>Aplicação de Estatística</b></p>  	<p>→ Iniciar "Aplicação de estatística" (LED ativa)</p>	<p><b>Aplicação de Totalização</b></p>  	<p>→ Iniciar "Aplicação de totalização" (LED ativa)</p>
 	<p>→ Adicionar uma nova amostra e pressionar «  ».</p>	 	<p>→ Adicionar uma nova amostra e pressionar «  ».</p>
 	<p>→ Se necessário, imprimir subtotal pressionar «  »</p>	 	<p>→ Se necessário, imprimir subtotal pressionar «  »</p>
 	<p>→ Imprimir e encerrar a "Aplicação de estatística" (LED desativado).</p>	 	<p>→ Imprimir e encerrar a "Aplicação de totalização" (LED desativado).</p>

**Notas Importantes**

- 1) No máximo 999 amostras podem ser armazenadas em cada uma das aplicações acima (estatísticas e totalização).
- 2) O peso mínimo da amostra deve ser maior que 1d.
- 3) Durante a aplicação, a alteração do peso da amostra no prato de pesagem deve ser superior a 100d, caso contrário, a impressora não registrará a alteração da amostra.
- 4) O relatório para aplicativos de estatísticas inclui: número de amostras, valor médio, desvio padrão, mínimo, máximo, diferencial mínimo-máximo e peso total.

## 5 Teste da Impressora

A impressora está equipada com um autoteste que automaticamente imprime o conjunto de caracteres da impressora (IBM/DOS padrão).

### Iniciando o teste

- Pressione a tecla «  » e ligue a impressora. A impressora imprime as configurações atuais.

### Encerrando teste

- Desligue a impressora.

## 6 Manutenção

Sob condições normais, a impressora praticamente não exige manutenção. O departamento de serviço da OHAUS estará disponível se for necessária manutenção. Favor consultar detalhes com seu representante OHAUS responsável.

### 6.1 Trocando o Rolo de Papel

A inserção de um novo rolo de papel está descrita no capítulo 2.4. Consultar o capítulo 9 (Consumíveis) para o número de pedido de rolo de papel.

**Nota:** Você pode obter o eixo giratório de papel do rolo de papel antigo.

### 6.2 Substituindo a Fita



- Retire a tampa de papel (1)
- Retire o papel da unidade de impressão (2)



- Para retirar o cartucho de fita, pressione na direção da seta (3).
- Insira a nova fita e, se necessário, ajuste a folga da roda tensionadora (4). Ver o capítulo 9 (Consumíveis) quanto ao número de pedido do cartucho.
- A inserção de um novo rolo de papel está descrita no capítulo 2.4

## 6.3 Limpeza

Considerando que o gabinete da impressora é confeccionado com materiais de grau superior, todos os agentes de limpeza neutros disponíveis comercialmente poderão ser utilizados (ver precauções de segurança no capítulo 2.1).

## 6.4 Descarte



### Descarte

Em conformidade com a Diretiva Europeia 2002/96/EC sobre Equipamentos Eletroeletrônicos Usados (WEEE), este aparelho não poderá ser descartado como lixo doméstico. Isso se aplica a países fora da União Europeia, conforme seus requisitos específicos.

Favor descartar esse produto em conformidade com os regulamentos locais e no ponto de coleta especificado para equipamentos eletroeletrônicos. Caso tenha dúvidas, favor contatar a autoridade responsável ou o distribuidor do qual adquiriu este aparelho .

Caso este aparelho seja repassado a terceiros (para utilização profissional ou particular), o conteúdo deste regulamento também deverá ser repassado.

Instruções de descarte na Europa disponíveis online em [www.ohaus.com/weee](http://www.ohaus.com/weee).

Grato por sua contribuição à proteção do meio ambiente.



## 7 Solução de Problemas

<b>Problema / Mensagem</b>	<b>Causa possível</b>	<b>Correção</b>
Impressão ilegível	<ul style="list-style-type: none"> <li>Fita gasta ou presa.</li> <li>Vida de serviço da unidade de impressão acabou.</li> </ul>	<ul style="list-style-type: none"> <li>Troquem o cartucho ou ajuste adequadamente a tensão da fita.</li> <li>Favor contatar o serviço OHAUS.</li> </ul>
Lâmpada-piloto não acende	<ul style="list-style-type: none"> <li>Sem energia.</li> <li>Falha no suprimento de energia.</li> </ul>	<ul style="list-style-type: none"> <li>Ligue a impressora.</li> <li>Favor contatar o serviço OHAUS.</li> </ul>
Lâmpada-piloto pisca	<ul style="list-style-type: none"> <li>Impressora não está conectada.</li> <li>Impressora não localizou as configurações do instrumento conectado.</li> </ul>	<ul style="list-style-type: none"> <li>Verifique se a impressora ou o instrumento está conectado.</li> <li>Ligue/desligue a impressora.</li> <li>Alternativamente, altere as configurações da impressora ou do instrumento conectado (ver capítulo 2.4)</li> </ul>
-----Timeout-----	<ul style="list-style-type: none"> <li>Transferência de dados não foi concluída nos últimos 45 s.</li> </ul>	<ul style="list-style-type: none"> <li>Transfira a balança para um local mais estável.</li> <li>Verifique a balança.</li> </ul>
-----Over Load-----	<ul style="list-style-type: none"> <li>Balança na faixa de sobrecarga.</li> <li>Zeragem fora da faixa de zero.</li> </ul>	<ul style="list-style-type: none"> <li>Verifique o peso da amostra.</li> <li>Altere a faixa de zero da balança.</li> <li>Altere a configuração da impressora de zero para tara.</li> </ul>
-----Under Load-----	<ul style="list-style-type: none"> <li>Balança em faixa de subcarga. Prato de pesagem não está na posição.</li> </ul>	<ul style="list-style-type: none"> <li>Verifique a balança.</li> </ul>
--Transmission Error--	<ul style="list-style-type: none"> <li>Instrumento não compreende a instrução da impressora.</li> </ul>	<ul style="list-style-type: none"> <li>Verifique as configurações de parâmetros de interface da impressora e do instrumento.</li> </ul>

<b>Problema / Mensagem</b>	<b>Causa possível</b>	<b>Correção</b>
-----Not Executable-----	<ul style="list-style-type: none"> <li>• Instrumento não consegue executar a instrução da impressora.</li> </ul>	<ul style="list-style-type: none"> <li>• Verifique a balança.</li> </ul>
---Date/Time Not Set--- -----Memory Error-----	<ul style="list-style-type: none"> <li>• Mensagens de erro da impressora.</li> </ul>	<ul style="list-style-type: none"> <li>• Verifique o instrumento.</li> <li>• Reset a impressora.</li> <li>• Ajuste data/horário. Baterias de reserva esgotadas. Favor contatar o serviço OHAUS.</li> </ul>
----- Memory full-----	<ul style="list-style-type: none"> <li>• Memória de Estatística ou Totalização está cheia. (mais de 999 amostras)</li> </ul>	<ul style="list-style-type: none"> <li>• Inicie uma nova aplicação de Estatística ou de Totalização.</li> </ul>
--Load/Unload Weight--	<ul style="list-style-type: none"> <li>• Nenhuma amostra ou a mesma amostra no prato de pesagem.</li> </ul>	<ul style="list-style-type: none"> <li>• Coloque uma nova amostra ou remova-a e coloque-a novamente no prato.</li> </ul>
Unit change not allowed!	<ul style="list-style-type: none"> <li>• Unidade alterada durante a aplicação de Estatística ou Totalização.</li> </ul>	<ul style="list-style-type: none"> <li>• Reset a balança.</li> <li>• Volte a unidade para a primeira.</li> </ul>
-----Out of range-----	<ul style="list-style-type: none"> <li>• Peso da amostra está fora da faixa</li> </ul>	<ul style="list-style-type: none"> <li>• Peso da amostra deverá estar na faixa de 70% - 130% do valor médio atual.</li> </ul>

## 8 Configurações Recomendadas

Aparelho Conectado		Configurações do Aparelho	Configurações da Impressora
DV, AV, PA, AR, AX, PX SP, TA, NV, NVL, NVT, MB35/45, MB23/25, MB90/120 (T31P, T51P, T71P, T32XW, T32WE, T51 XW, T71XW, CKW)*		Modo da Impressora Taxa baud: 9600 Bit / Paridade: 8 bit None 1 Handshake: Xon/Xoff	Configurações de Fábrica
EX		Modo da Impressora Taxa baud: 9600 Bit / Paridade: 8 bit None 1 Handshake: Xon/Xoff	Configurações de Fábrica
	Russo	Modo da Impressora Taxa baud: 9600 Bit / Paridade: 8 bit None 1 Handshake: Xon/Xoff Idioma: ANSI/WIN Russo	CP1251 Windows Cyrillic
	Polonês	Modo da Impressora Taxa baud: 9600 Bit / Paridade: 8 bit None 1 Handshake: Xon/Xoff Idioma: ANSI/WIN Polonês	CP852 MS-DOS Latin2
	Checo	Modo da Impressora Taxa baud: 9600 Bit / Paridade: 8 bit None 1 Handshake: Xon/Xoff Idioma: ANSI/WIN Checo	CP852 MS-DOS Latin2
	Húngaro	Modo da Impressora Taxa baud: 9600 Bit / Paridade: 8 bit None 1 Handshake: Xon/Xoff Idioma: ANSI/WIN Húngaro	CP852 MS-DOS Latin2
	Português	Modo da Impressora Taxa baud: 9600 Bit / Paridade: 8 bit None 1 Handshake: Xon/Xoff Idioma: ANSI/WIN Português	CP860 MS-DOS Portuguese
	Inglês, francês, alemão, italiano, espanhol, chinês, japonês, coreano	Modo da Impressora Taxa baud: 9600 Bit / Paridade: 8 bit None 1 Handshake: Xon/Xoff	Configurações de Fábrica

**Nota:** \* As funções de Estatística e Totalização da impressora são suportadas nos seguintes modelos: DV, EX, AV, PA, NV, MB23 / 25, AX e PX.

Apenas a função de impressão é suportada em todos os outros modelos.

## 9 Consumíveis e Peças Sobressalentes

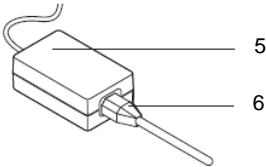
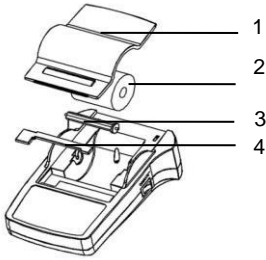

Pos.	Item	Número de Peça	Quantidade fornecida
1	Tampa de Papel	30047939	1 unidade
2	Rolo de Papel	12120799	1 unidade
3	Eixo Giratório de Papel	30063920	1 unidade
4	Cartucho, preto	30529322	1 unidade
5	Adaptador AC/DC (sem cabo de alimentação) 100 - 240 VAC, 50 - 60 Hz, 12 VDC 2.5 A	30529321	1 unidade
6	Cabo de alimentação CH	30064089	1 unidade
	Cabo de alimentação EU	12120761	1 unidade
	Cabo de alimentação US	12120762	1 unidade
	Cabo de alimentação IT	30064200	1 unidade
	Cabo de alimentação GB	12120312	1 unidade
	Cabo de alimentação AU	12120313	1 unidade
	Cabo de alimentação BR	83033772	1 unidade
	Cabo de alimentação JP	12122638	1 unidade
-	RS9 M/F Cabo, 1.5m	30529323	1 unidade

## 10 Interface RS232C

A impressora SF40A está equipada com interface RS232C para conexão com instrumentos OHAUS.

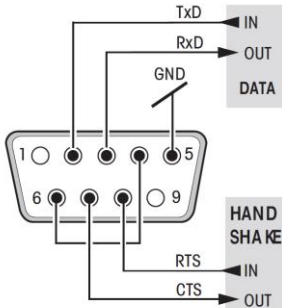

- Conector macho de 9 pinos
- Compatibilidade com outros aparelhos (parâmetros de transmissão), ver capítulo 8.

## 11 Dados Técnicos

Alimentação	Adaptador AC/DC: 12 VDC, 2.5 A Primário: 100 – 240 VAC, -50 -60 Hz Flutuações de voltagem: até $\pm 10\%$ da voltagem nominal Secundário: 12 VDC, 2.5 A (com proteção eletrônica de sobrecarga)
Cabo do adaptador AC/DC	3 núcleos, com plugue específico ao país
Voltagem de linha de alimentação	12 VDC
Consumo de energia	Max. 2.5 A
Altitude	até 2000 m
Temperatura ambiente	0 °C – 40 °C
Umidade relativa	No máximo 80% a 31 °C, diminuindo linearmente até 50% a 40 °C, sem condensação
Categoria de sobrevoltagem	Classe II
Grau de poluição	2
Unidade impressora	Impressora matricial 5x7, comprimento de linha de 40 caracteres
Velocidade de impressão	1.2 linha por segundo
Cartucho	Substituível, preto
Rolo de papel	Papel padrão 57.5 mm x $\varnothing$ 50 a 60 mm, integrado no gabinete, tamanho comercial
Qualidade de impressão	Impressão com estabilidade térmica e resistente à luz (GLP, GMP, ISO9001)
Interface	RS232C
Dimensões da impressora	(LxDxA) 120 mm x 203 mm x 73 mm
Dimensões da embalagem	(LxDxA) 255 mm x 205 mm x 150 mm
Peso líquido	740 g (incluindo o rolo de papel)
Limites de compatibilidade	<ul style="list-style-type: none"><li>• Função Data / Horário: não aplicável a balanças com relógio integrado (relógio integrado possui prioridade)</li><li>• Funções Zero / Tara, Estatística e Totalização: não aplicável a todos os modelos de balança</li></ul>







OHAUS Corporation  
7 Campus Drive  
Suite 310  
Parsippany, NJ 07054 USA  
Tel: +1 973 377 9000  
Fax: +1 973 944 7177

With offices worldwide / Con oficinas alrededor del mundo / Avec des bureaux dans le monde entier / Weltweite Geshäftsstellen / Con uffici in tutto il mondo.

**[www.ohaus.com](http://www.ohaus.com)**



\* 3 0 0 6 3 9 1 9 \*

P/N 30063919F © 2021 OHAUS Corporation, all rights reserved / todos los derechos reservados / tous droits réservés / Alle Rechte vorbehalten / tutti i diritti riservati.

Printed in China / Impreso en la China / Imprimé en Chine / Gedruckt in China / Stampato in Cina