

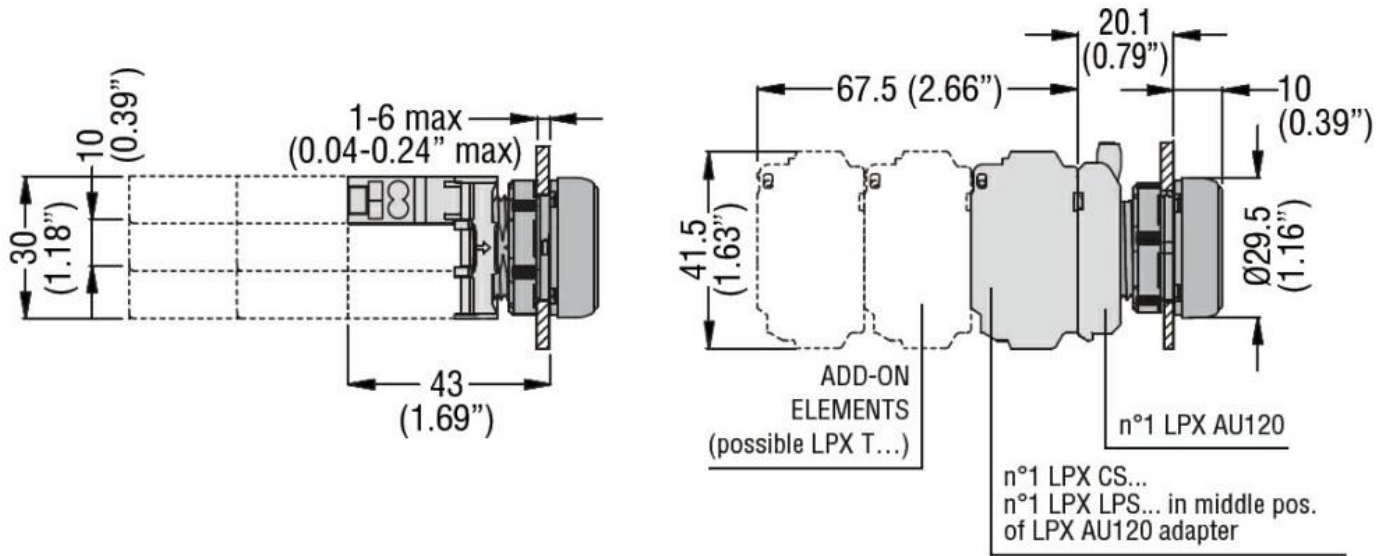

Product designation	LED elements steady light with spring-clamp terminals		
Product type designation	LPXLP		
General characteristics			
Colour	Blue		
Electrical characteristics			
Rated frequency	Hz	50-60	
Supply voltage (AC)	V	85...140	
Operations			
Electrical life	hours	100000	
Mechanical features			
Conductor section	AWG/kcmil conductor section		
	max	14	
	IEC		
	max	mm ²	1 or 2 / 2.5
Mounting adapter	LPXAU120		
Weight	g	15	
Ambient conditions			
Temperature	Operating temperature		
	min	°C	-25
	max	°C	+70
	Storage temperature		
	min	°C	-40
	max	°C	+85
Dimensions			

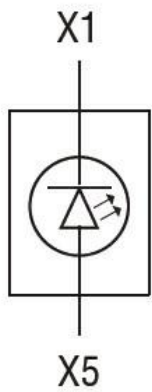

Wiring diagrams



Certifications and compliance

Compliance

CSA C22.2 n° 14
IEC/EN 60947-1
IEC/EN 60947-5-1
UL508

Certificates

CCC
cULus
EAC
RINA
UL