

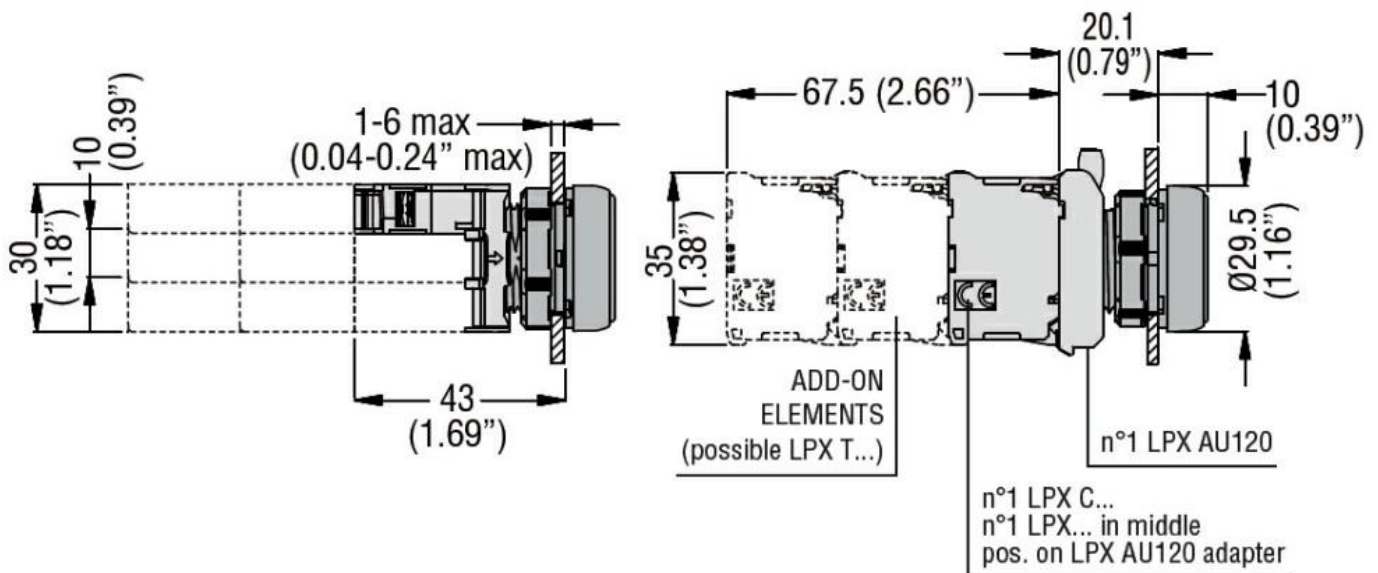

Product designation	LED elements steady light LPXLP		
Product type designation	LPXLP		
<b>General characteristics</b>			
Colour	Yellow		
<b>Electrical characteristics</b>			
Supply voltage (AC)	V	185...265	
Supply voltage (DC)	V	185...265	
<b>Operations</b>			
Electrical life	hours	100000	
<b>Mechanical features</b>			
Tightening torque for terminals max	Nm	1	
Conductor section	AWG/kcmil conductor section		
	max	12	
	IEC		
	max	mm <sup>2</sup>	1 or 2 / 2.5
Mounting adapter	LPXAU120		
Weight	g	16	
<b>Ambient conditions</b>			
Temperature	Operating temperature		
	min	°C	-25
	max	°C	+70
	Storage temperature		
	min	°C	-40
	max	°C	+85

**Dimensions**



### Wiring diagrams

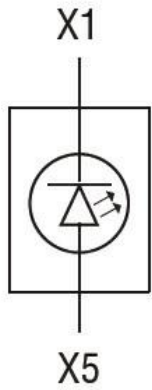

### Certifications and compliance

#### Compliance

CSA C22.2 n° 14

IEC/EN 60947-1

IEC/EN 60947-5-1

UL508

#### Certificates

CCC

cULus

EAC

RINA

UL