



Product designation	Pushbutton actuator, spring return	
Product type designation	LPCB30	
<b>General characteristics</b>		
Colour	Blue	
Material	Polyamide	
IEC degree of protection	IP66, IP67 and IP69K	
<b>Mechanical features</b>		
Operating force	kg-lb	<0.5Kg / 1.1lb
Mechanical life - spring return actuators	cycles	5000000
Mechanical life - Push-Push actuators	cycles	500000
Operating position	allowable	Any
Fixing	Flush (without mounting adapter)	
Mounting adapter	LPXAU120	
Weight	g	27

<b>UL technical data</b>		
UL degree of protection	Type1, 2, 3R, 4, 4X, 12, 12K	

<b>Ambient conditions</b>		
Temperature		
Operating temperature	min	°C -25
	max	°C +70
Storage temperature	min	°C -40
	max	°C +85

**Dimensions**

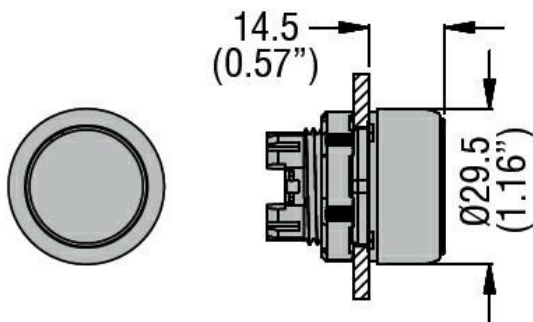

**Certifications and compliance**

Compliance	CSA C22.2 n° 14
------------	-----------------

---

IEC/EN 60947-1

---

IEC/EN 60947-5-1

---

UL508

---

Certificates

---

CCC

---

cULus

---

EAC

---

RINA