

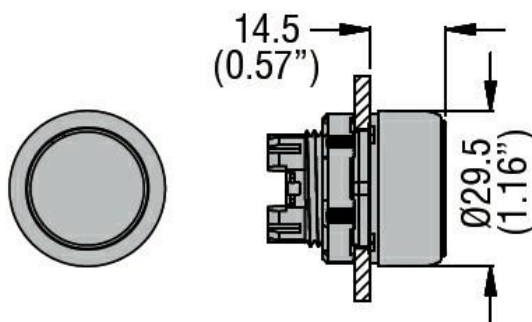

Product designation	Pushbutton actuator, spring return		
Product type designation	LPCB30		
General characteristics			
Colour	Green		
Material	Polyamide		
IEC degree of protection	IP66, IP67 and IP69K		
Mechanical features			
Operating force	kg-lb	<0.5Kg / 1.1lb	
Mechanical life - spring return actuators	cycles	5000000	
Mechanical life - Push-Push actuators	cycles	500000	
Operating position	allowable	Any	
Fixing	Flush (without mounting adapter)		
Mounting adapter	LPXAU120		
Weight	g	27	
UL technical data			
UL degree of protection	Type1, 2, 3R, 4, 4X, 12, 12K		
Ambient conditions			
Temperature	Operating temperature		
	min	°C	-25
	max	°C	+70
	Storage temperature		
	min	°C	-40
	max	°C	+85

Dimensions



Certifications and compliance

Compliance

CSA C22.2 n° 14

IEC/EN 60947-1

IEC/EN 60947-5-1

UL508

Certificates

CCC

cULus

EAC

RINA