

4

3

2

1

D

D

C

C

B

B

A

A

4

3

2

1

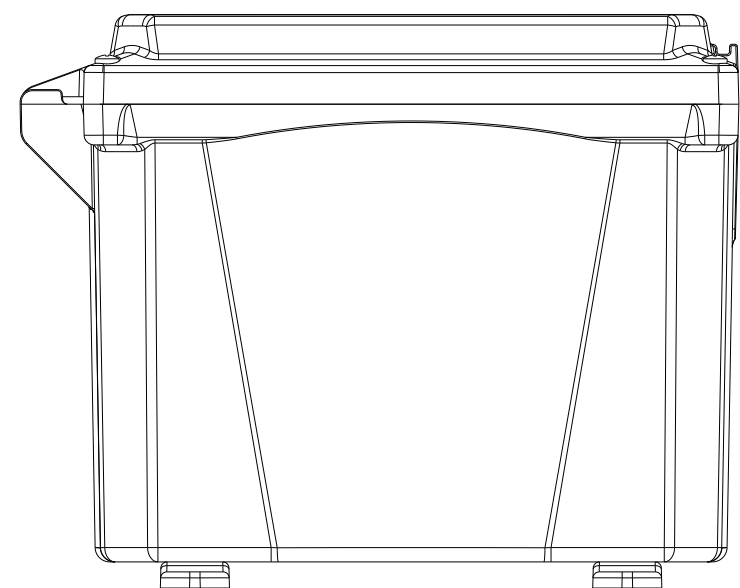
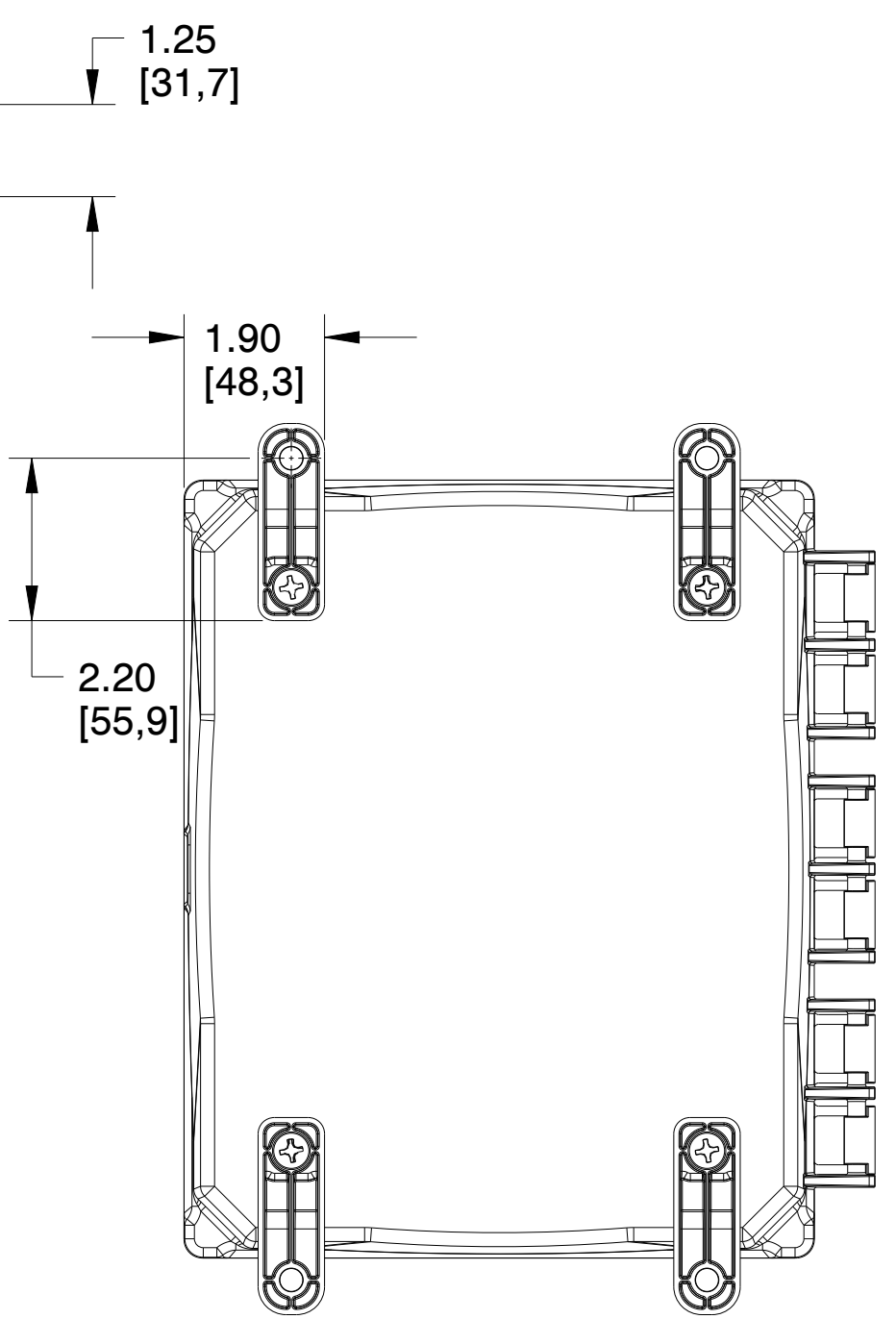
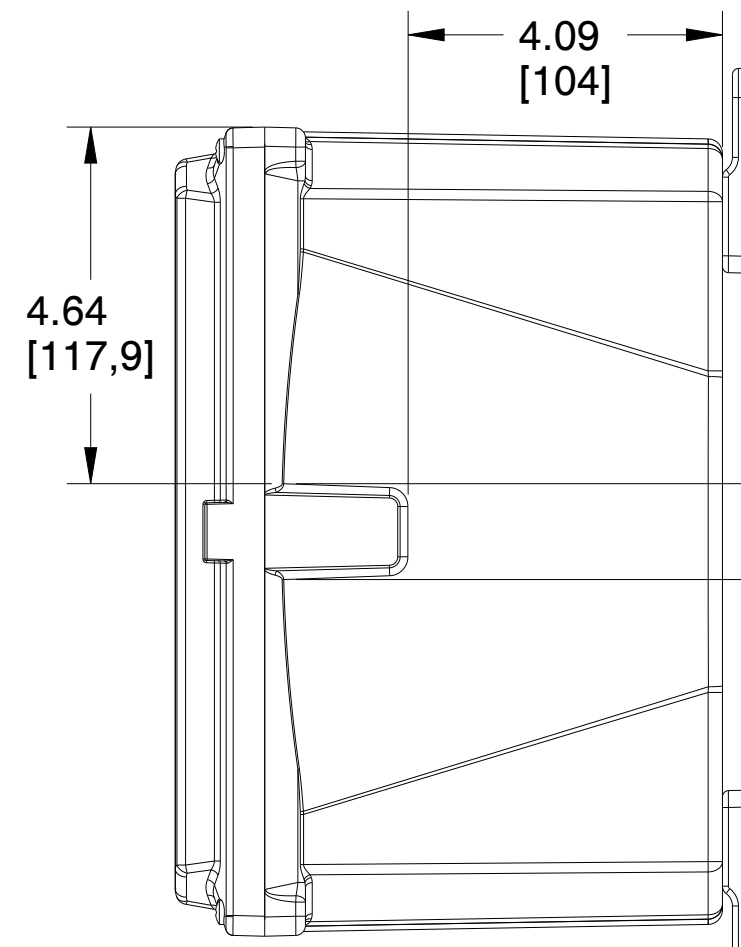
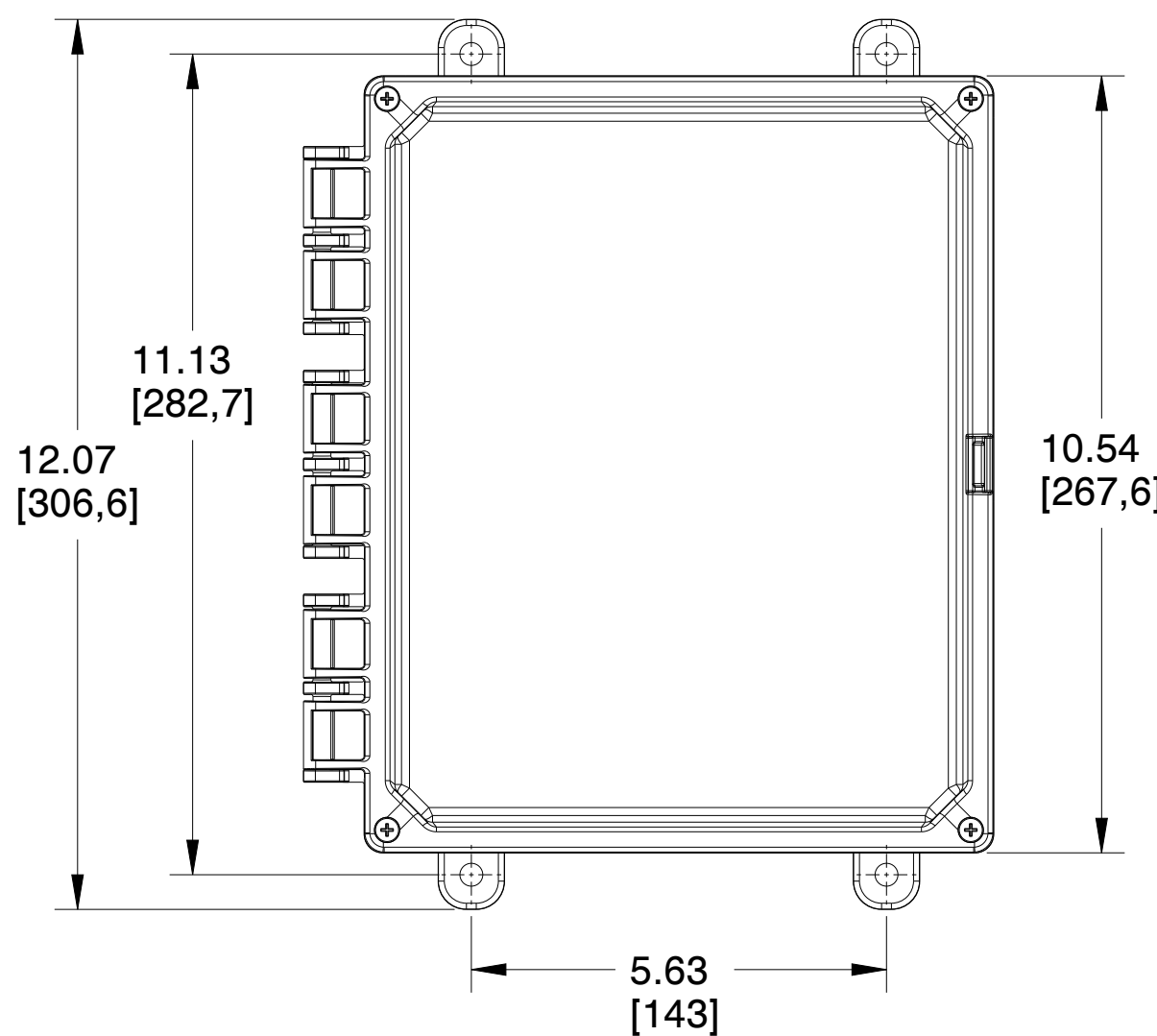
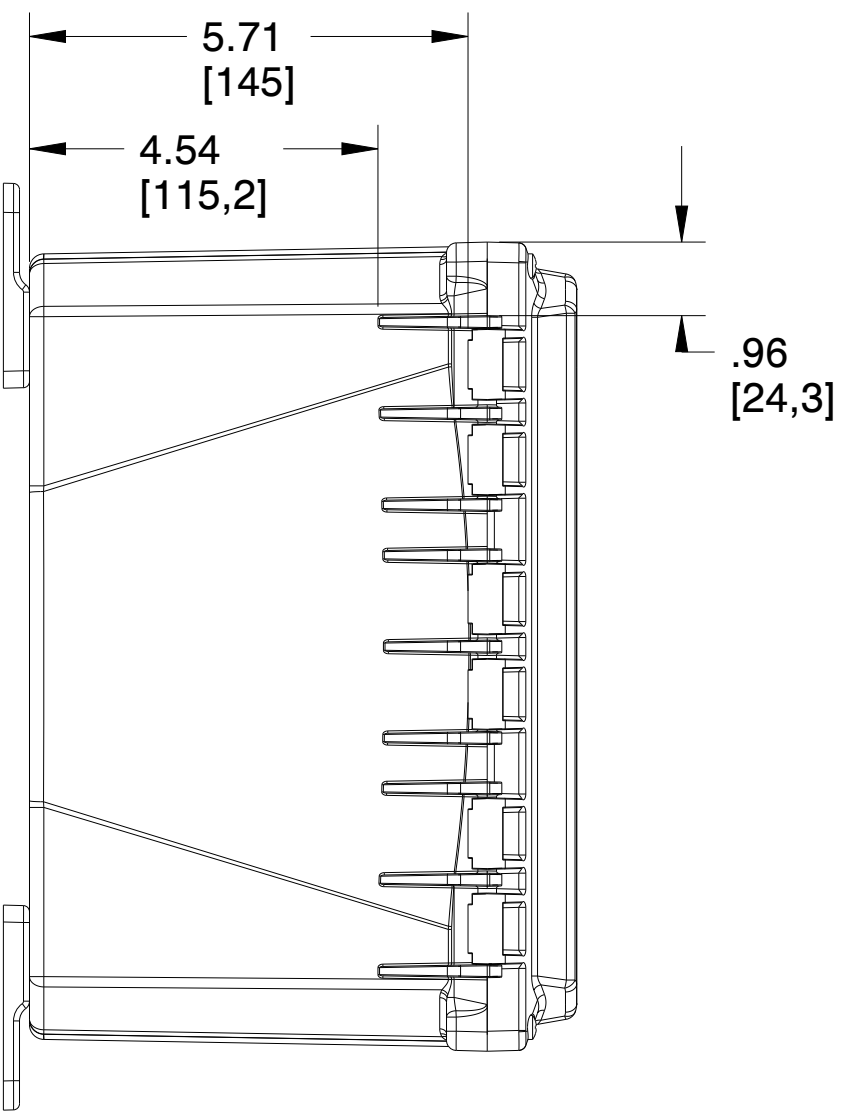
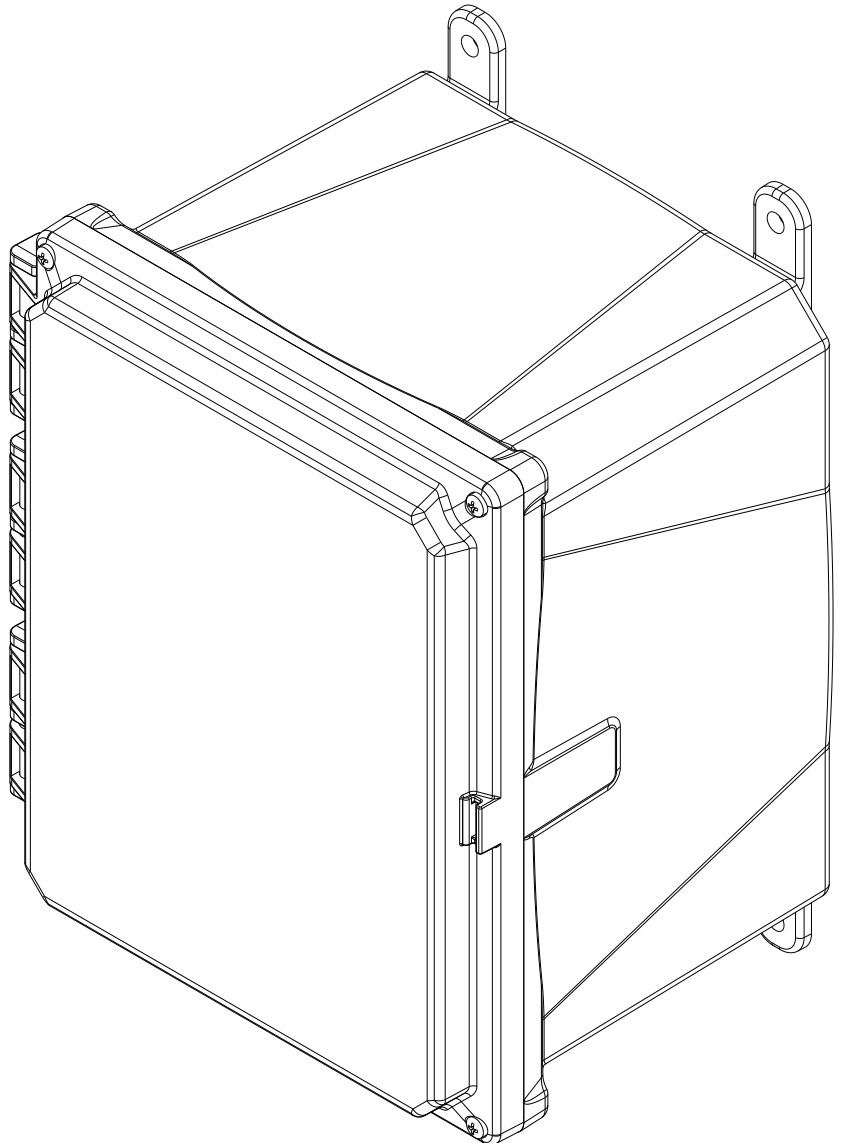
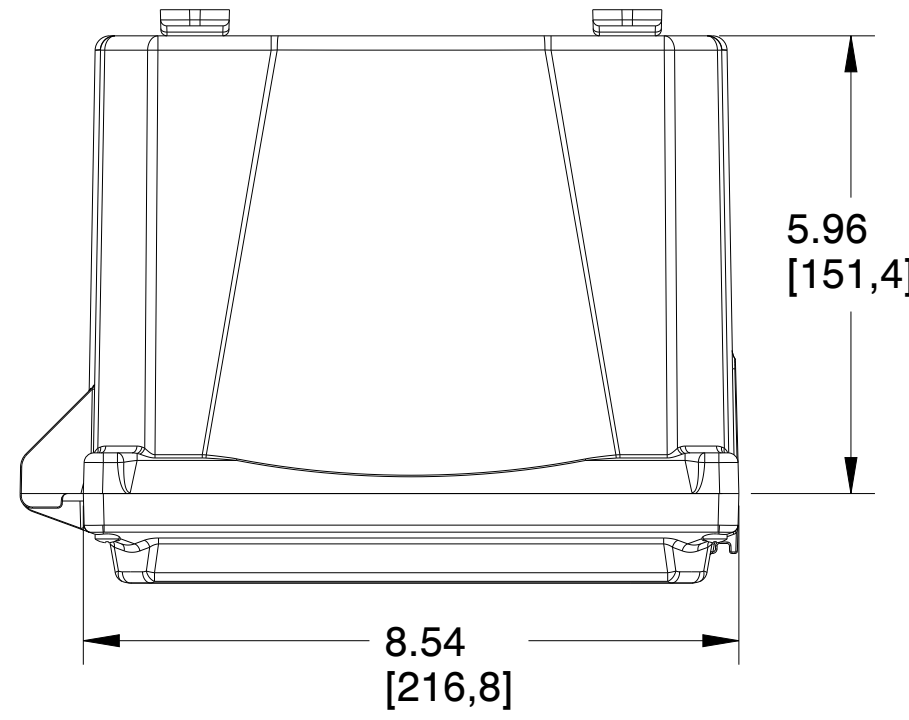

		MUM INDUSTRIES 8989 TYLER BLVD MENTOR, OHIO, U.S.A. (440) 269-8155 FAX (440) 269-8166	
SCALE	SHEET	DRAWN BY	
0.400	1 of 2	T.PAUL	
TITLE			
PREM-10X8X6-HNG			
DATE	DRAWING NUMBER	REV	
07.14.2021	H10086H	A	

UNLESS OTHERWISE SPECIFIED:
DIMENSIONS ARE IN INCHES (mm)
AND ARE NOMINAL ONLY

PROPRIETARY AND CONFIDENTIAL:
THE INFORMATION CONTAINED IN THIS
DRAWING IS THE SOLE PROPERTY OF
INTEGRA ENCLOSURES. ANY
REPRODUCTION IN PART OR AS A
WHOLE WITHOUT THE WRITTEN
PERMISSION OF INTEGRA
ENCLOSURES IS PROHIBITED.

4

3

2

1

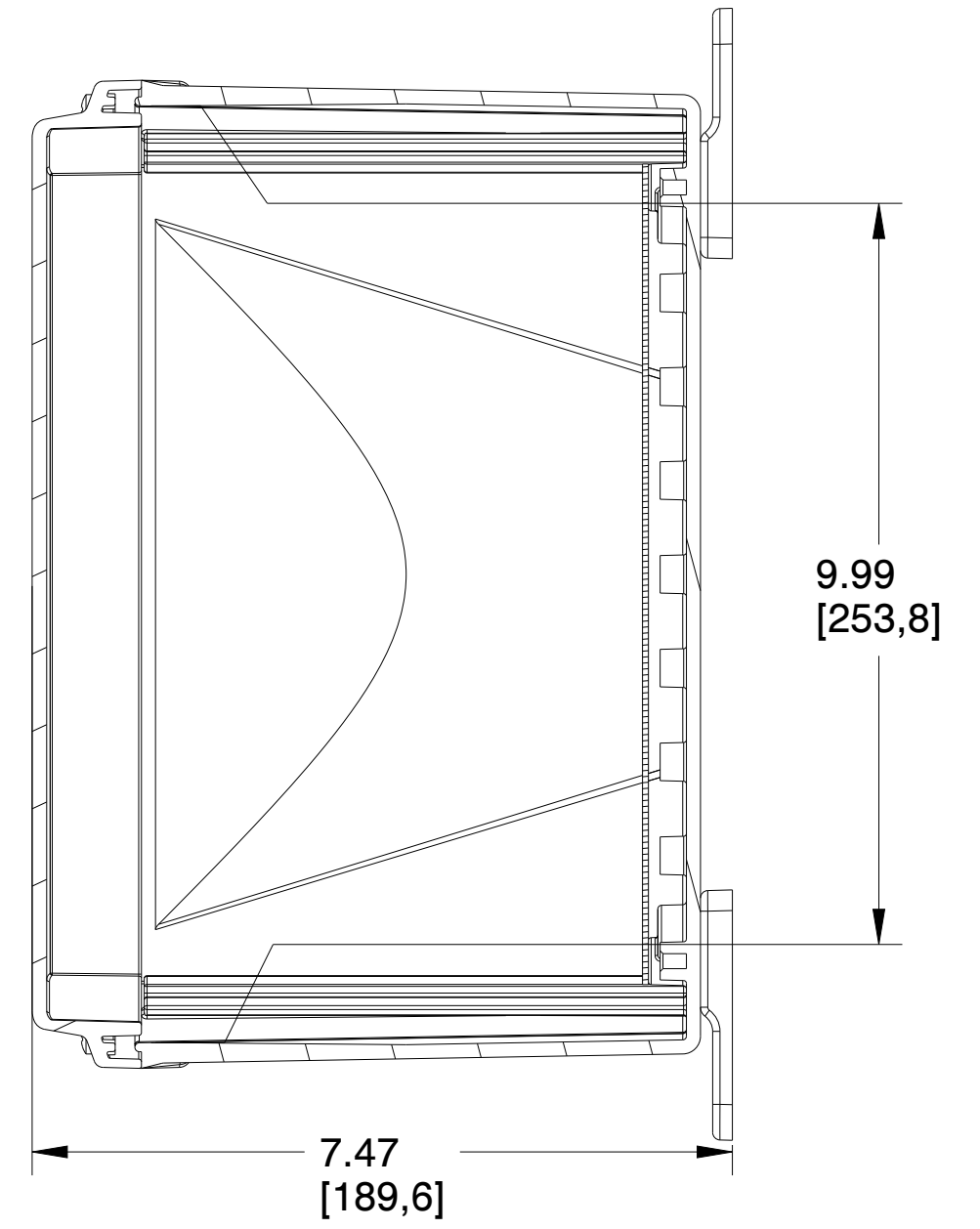
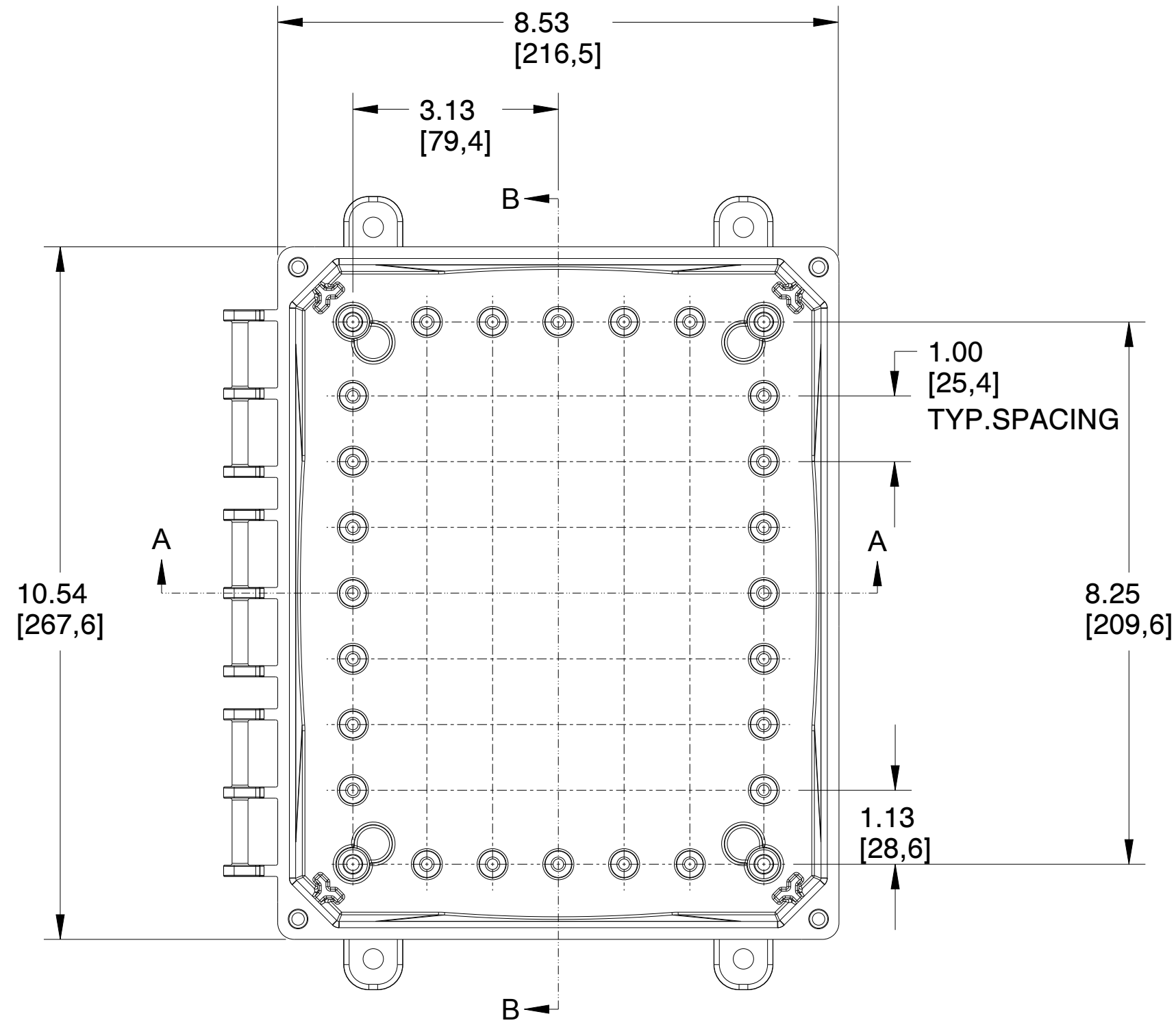

SECTION B-B

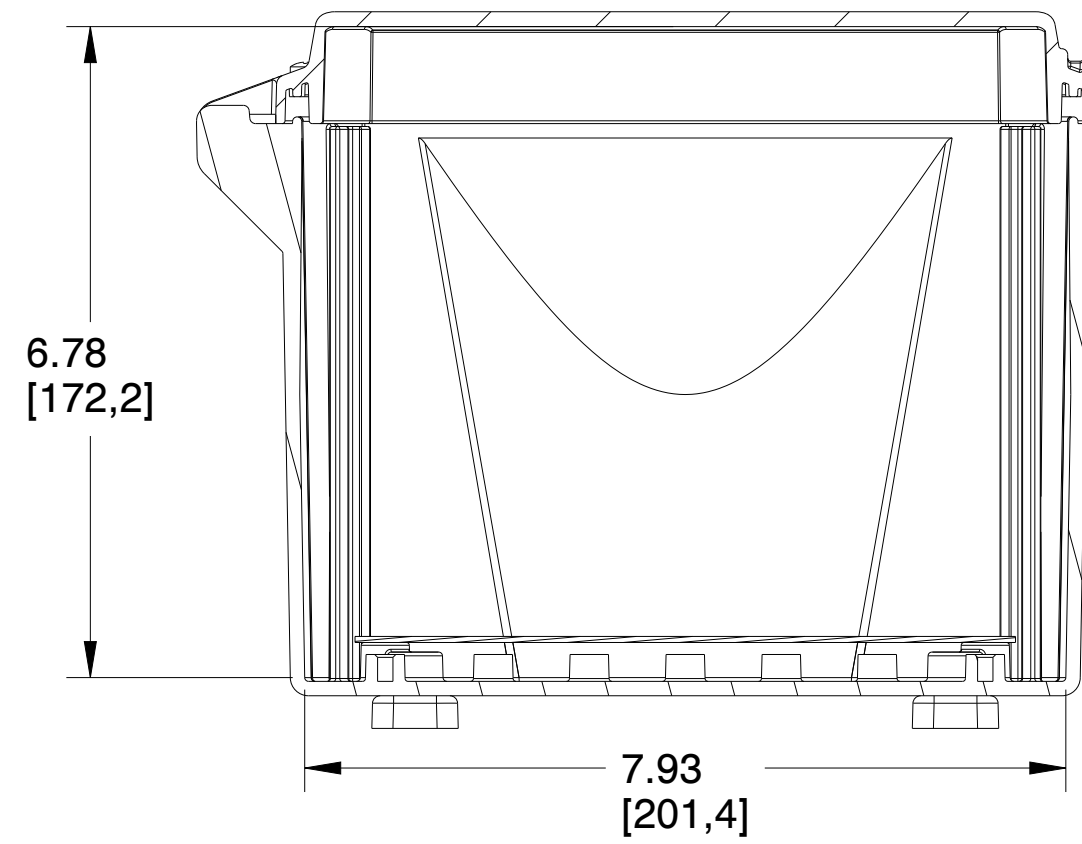

SECTION A-A

		MUM INDUSTRIES 8989 TYLER BLVD MENTOR, OHIO, U.S.A. (440) 269-8155 FAX (440) 269-8166	
SCALE	SHEET	DRAWN BY	
0.500	2 of 2	T.PAUL	
TITLE			
PREM-10X8X6-HNG			
DATE	DRAWING NUMBER	REV	
07.14.2021	H10086H	A	

UNLESS OTHERWISE SPECIFIED:
DIMENSIONS ARE IN INCHES (mm)
AND ARE NOMINAL ONLY

PROPRIETARY AND CONFIDENTIAL:
THE INFORMATION CONTAINED IN THIS
DRAWING IS THE SOLE PROPERTY OF
INTEGRA ENCLOSURES. ANY
REPRODUCTION IN PART OR AS A
WHOLE WITHOUT THE WRITTEN
PERMISSION OF INTEGRA
ENCLOSURES IS PROHIBITED.

4

3

2

1