

4

3

2

1

D

D

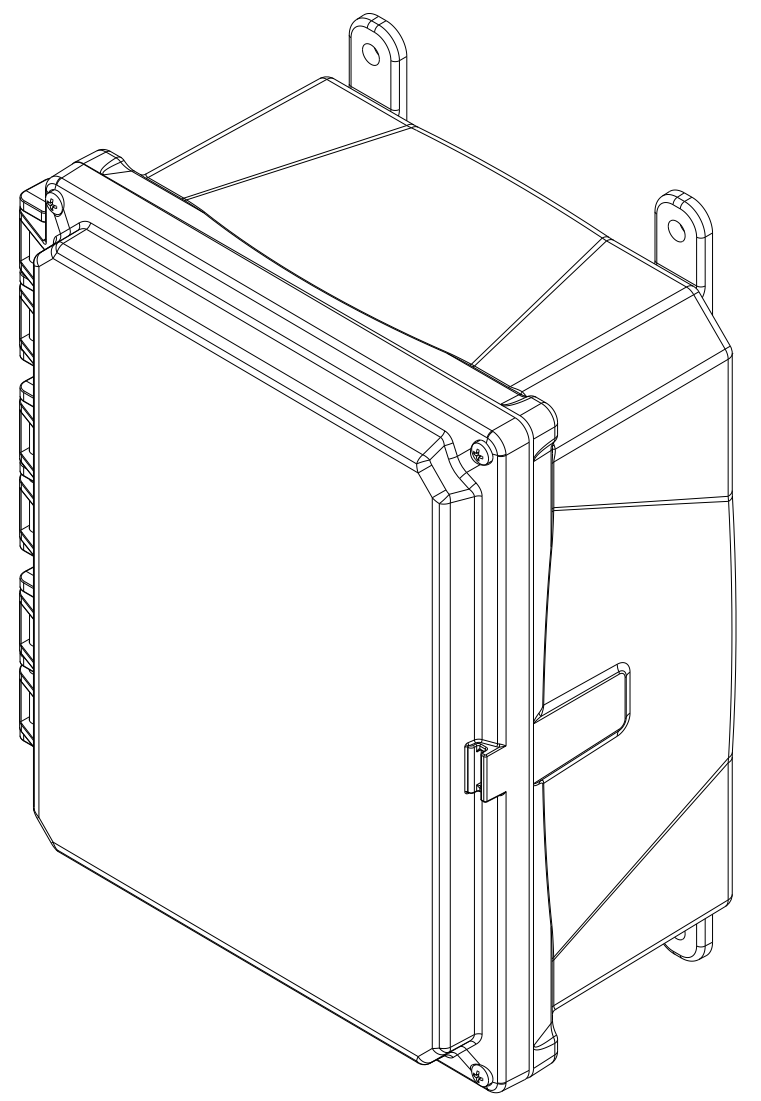
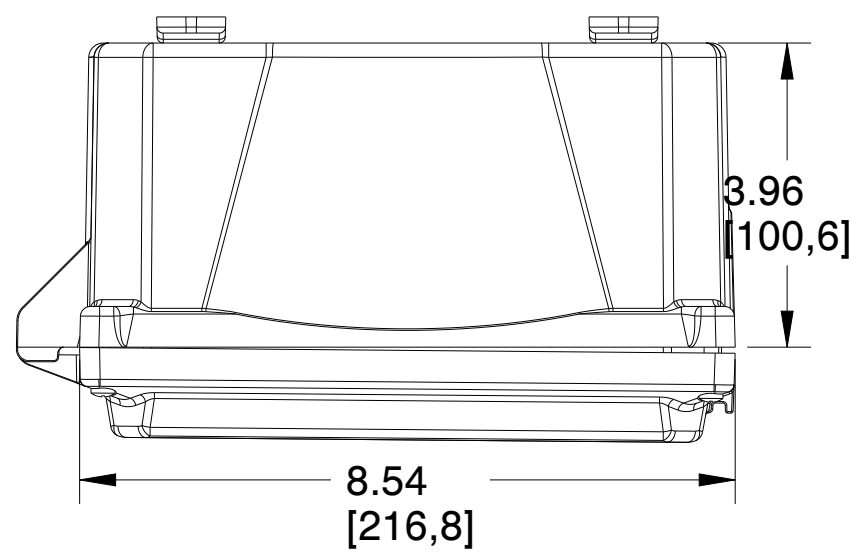

C

C

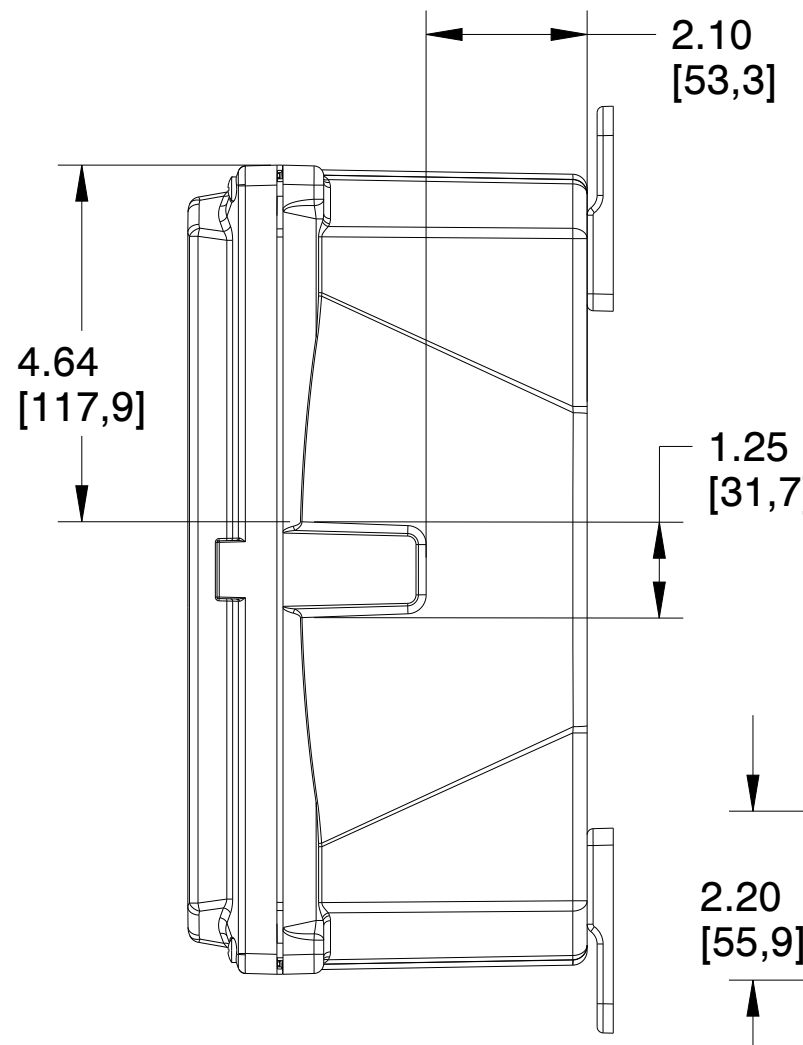
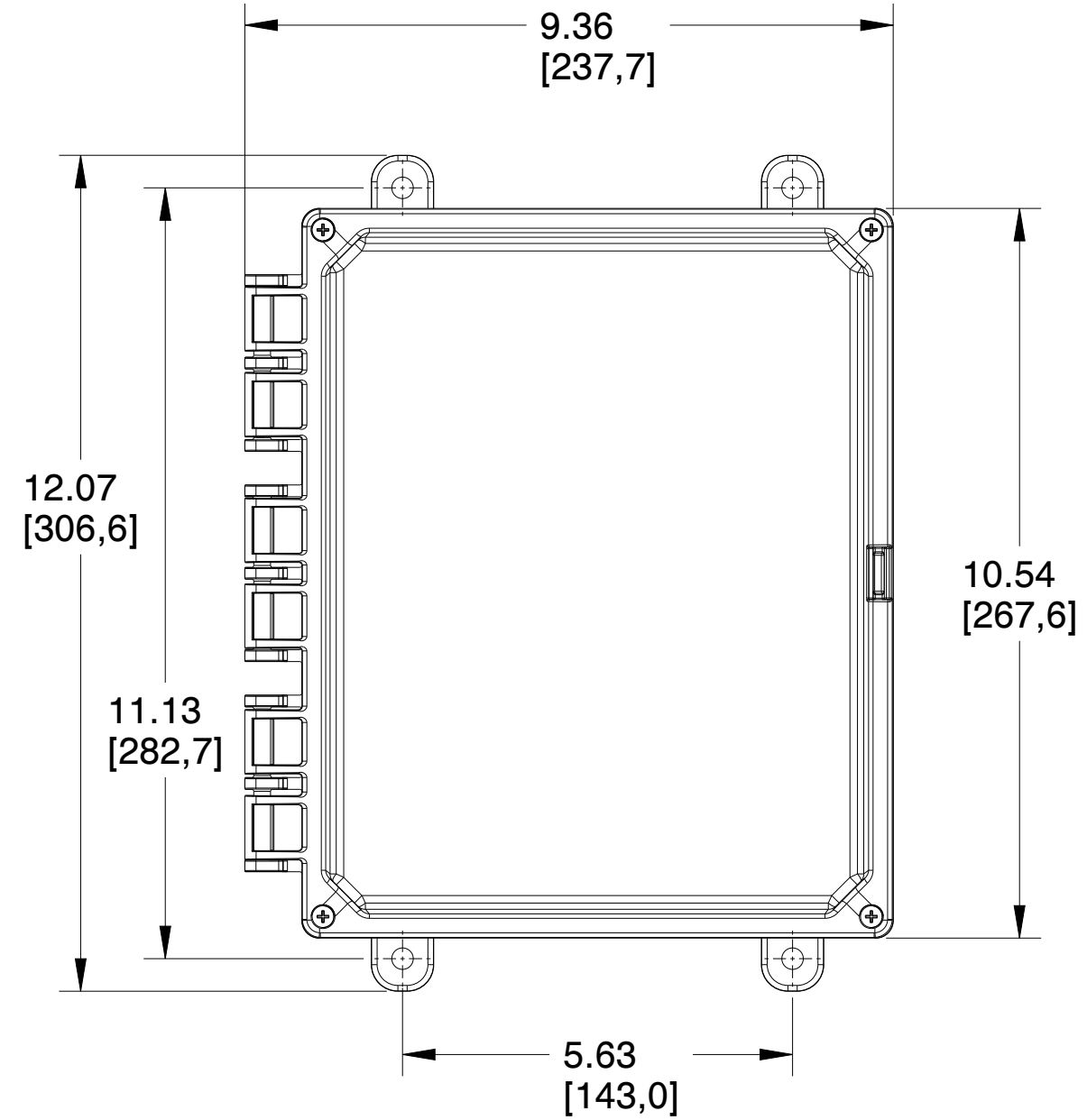
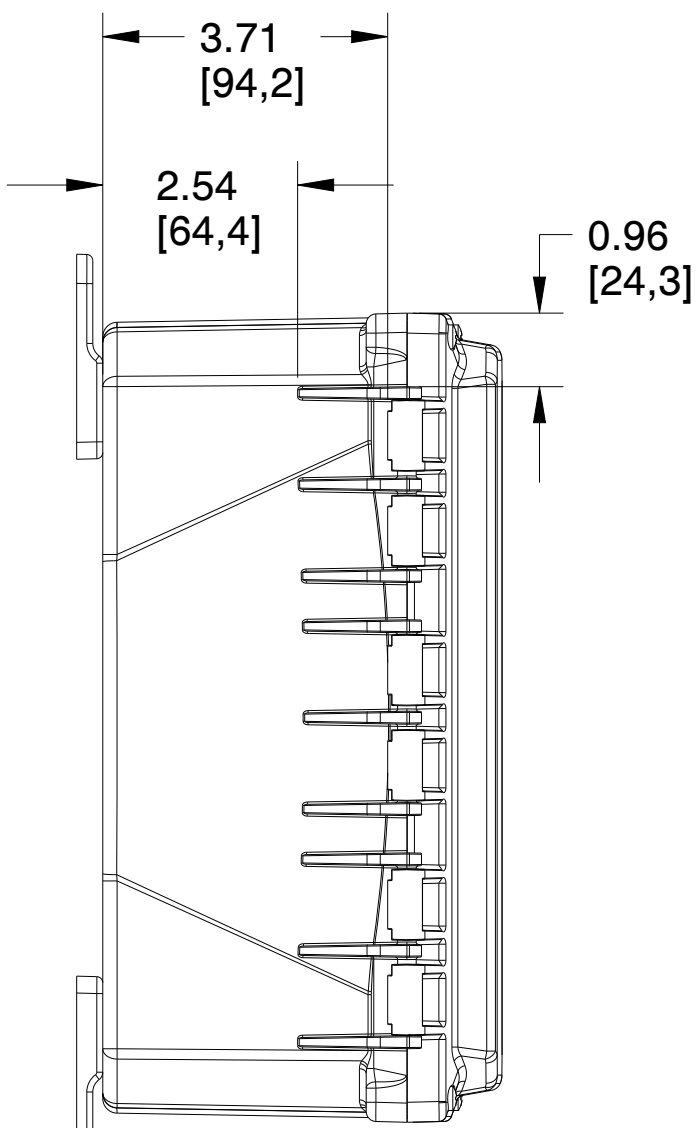

B

B

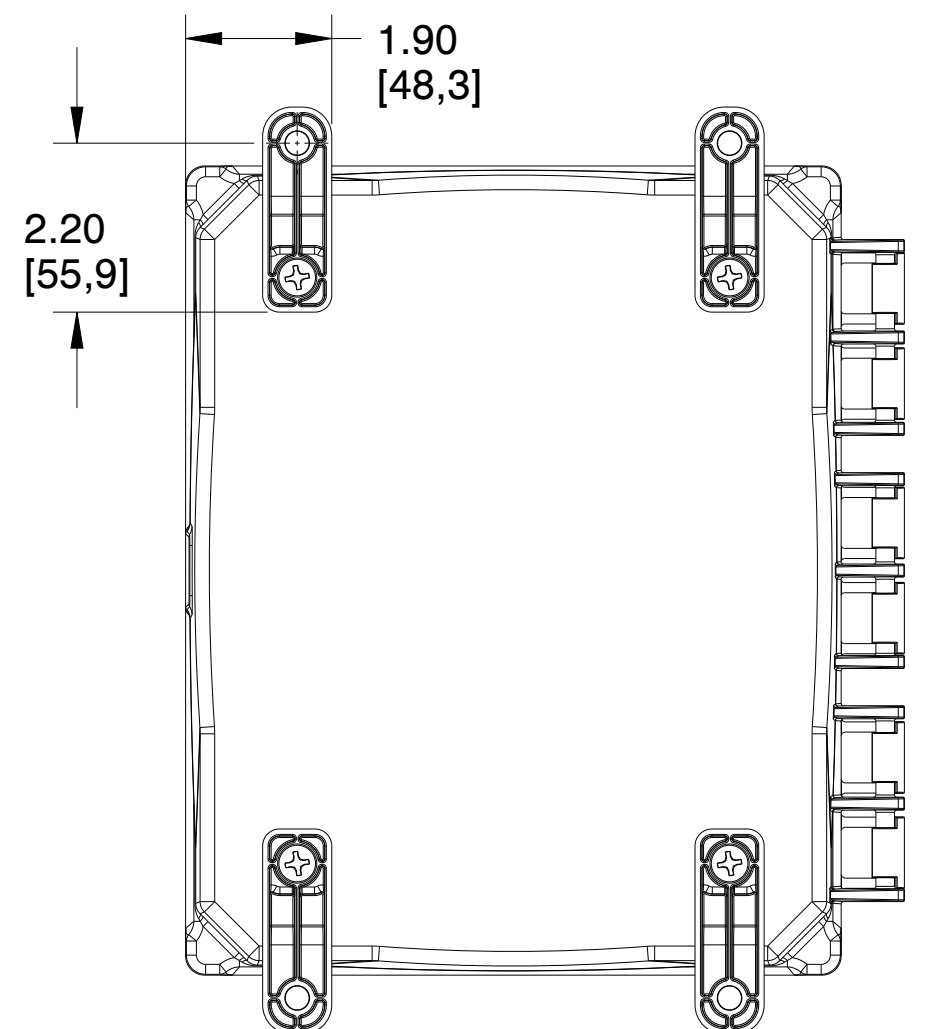

A

A

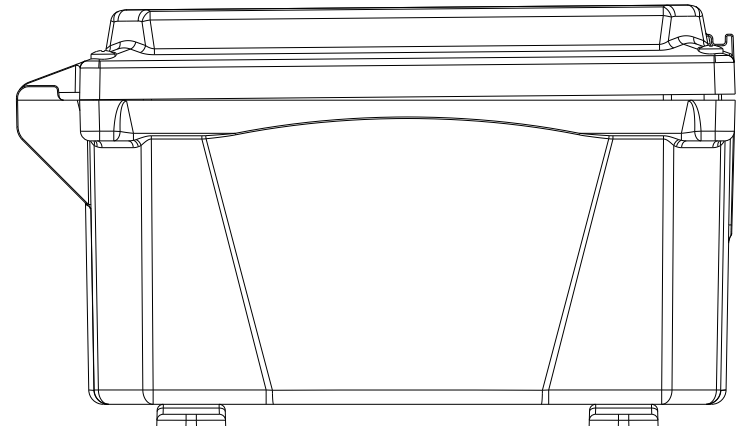

		MUM INDUSTRIES 8989 TYLER BLVD MENTOR, OHIO, U.S.A. (440) 269-8155 FAX (440) 269-8166	
SCALE	SHEET	DRAWN BY	
0.400	1 of 2	T.PAUL	
TITLE			
PREM-10X8X4-HNG			
DATE	DRAWING NUMBER	REV	
07.29.2021	H10084H	A	

UNLESS OTHERWISE SPECIFIED:
DIMENSIONS ARE IN INCHES (mm)
AND ARE NOMINAL ONLY

PROPRIETARY AND CONFIDENTIAL:
THE INFORMATION CONTAINED IN THIS
DRAWING IS THE SOLE PROPERTY OF
INTEGRA ENCLOSURES. ANY
REPRODUCTION IN PART OR AS A
WHOLE WITHOUT THE WRITTEN
PERMISSION OF INTEGRA
ENCLOSURES IS PROHIBITED.

4

3

2

1

4

3

2

1

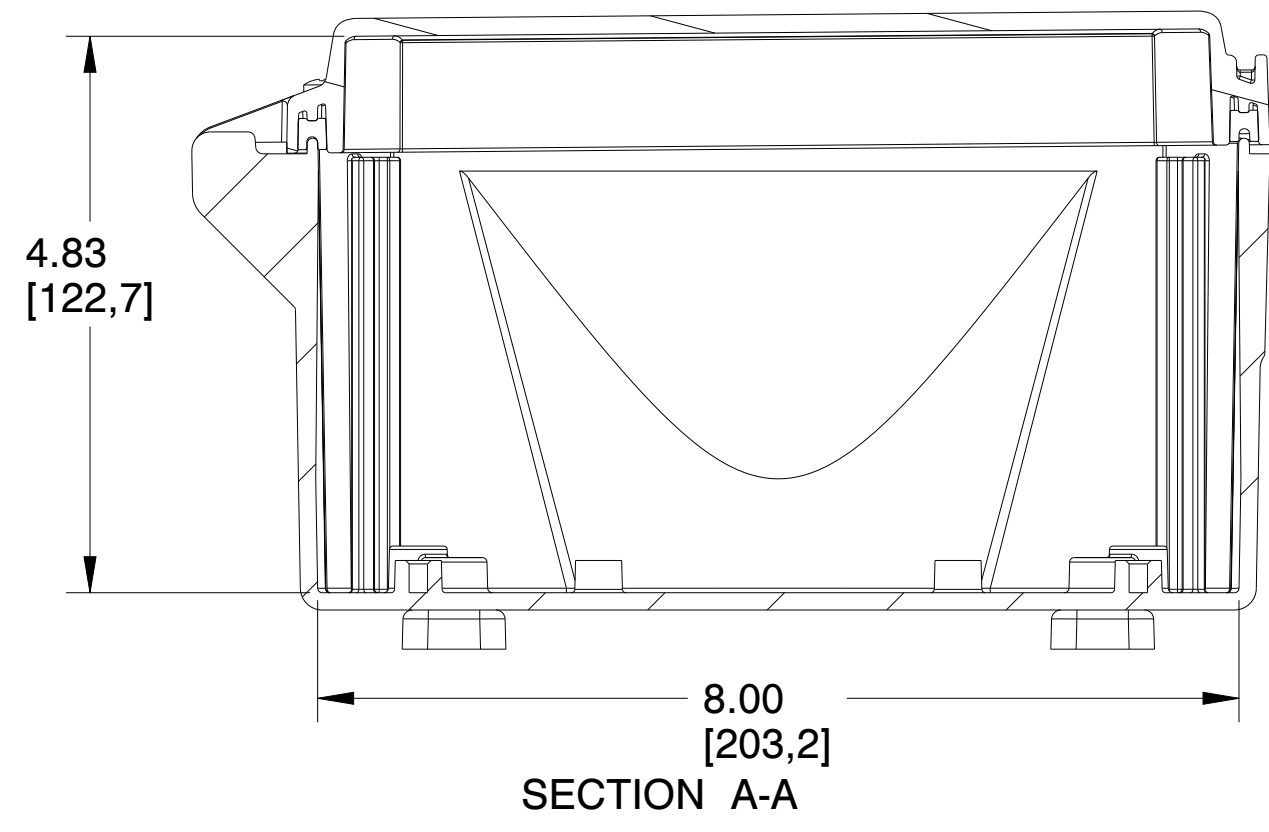
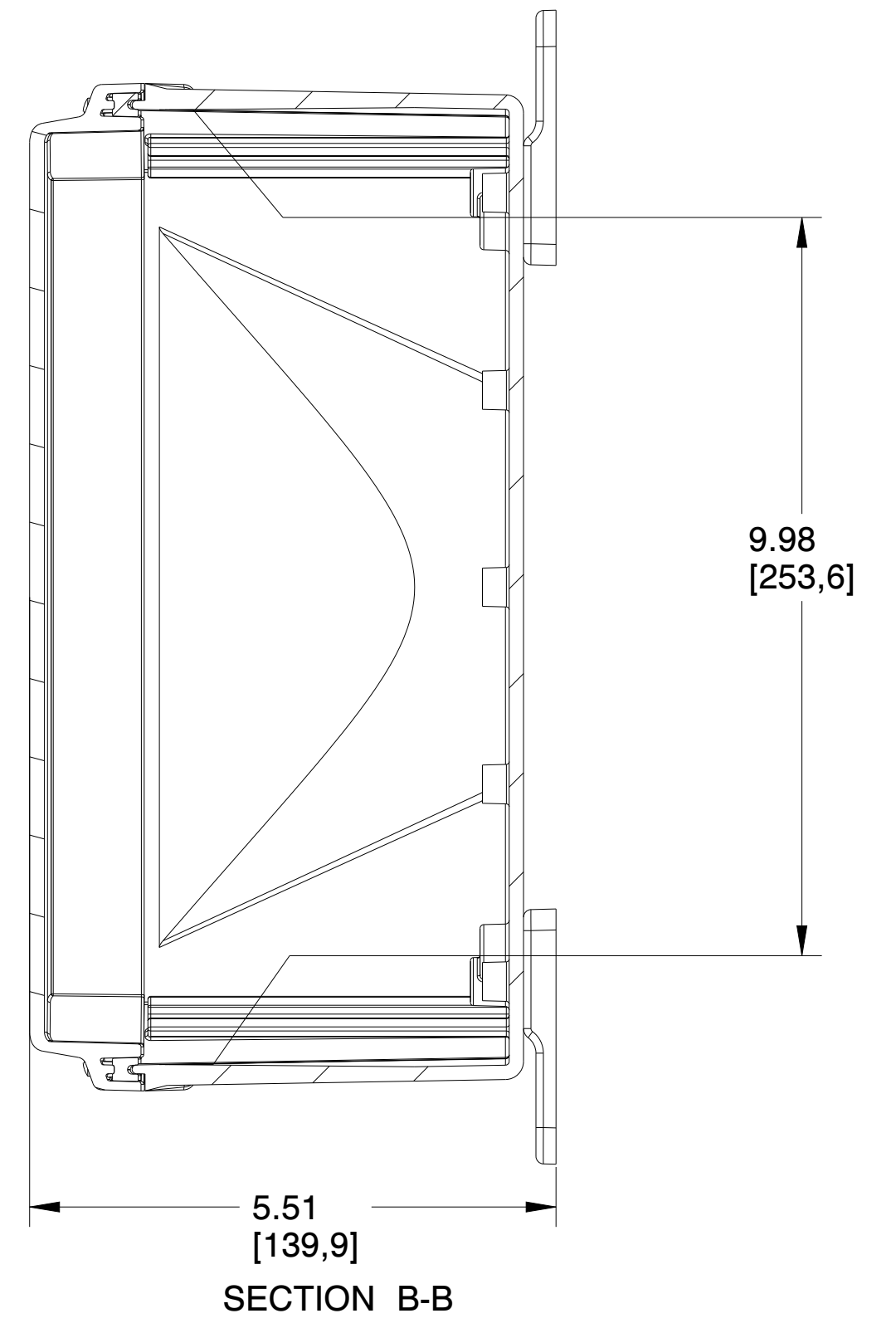
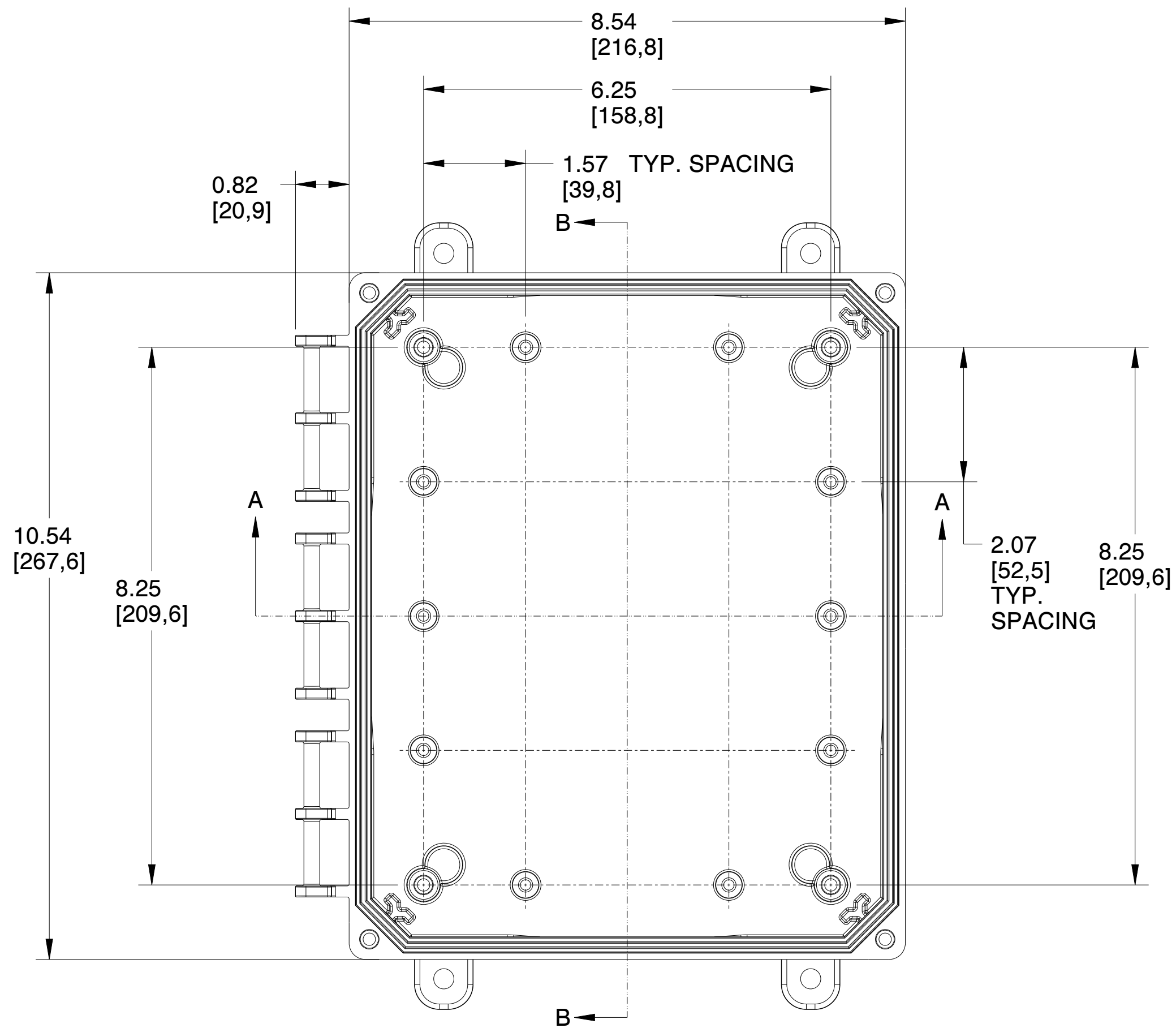

		MUM INDUSTRIES 8889 TYLER BLVD MENTOR, OHIO, U.S.A. (440) 269-8155 FAX (440) 269-8166	
SCALE	SHEET	DRAWN BY	
0.600	2 of 2	T.PAUL	
TITLE			
PREM-10X8X4-HNG			
DATE	DRAWING NUMBER	REV	
07.29.2021	H10084H	A	

UNLESS OTHERWISE SPECIFIED:
DIMENSIONS ARE IN INCHES (mm)
AND ARE NOMINAL ONLY

PROPRIETARY AND CONFIDENTIAL:
THE INFORMATION CONTAINED IN THIS
DRAWING IS THE SOLE PROPERTY OF
INTEGRA ENCLOSURES. ANY
REPRODUCTION IN PART OR AS A
WHOLE WITHOUT THE WRITTEN
PERMISSION OF INTEGRA
ENCLOSURES IS PROHIBITED.

4

3

2

1