

PART NAME

# DPH SERIES ENCLOSURE

PART No.

## DPH-28707 & DPH-28707-C

REVISION DATE

2/20/21

### NOTES:

- MATERIAL AND FLAMMABILITY RATING.  
 BODY - PC LIGHT GRAY POLYCARBONATE - UL94-5VA  
 COVER - PC LIGHT GRAY POLYCARBONATE - UL94-5VA  
 CLEAR COVER (C) - PC CLEAR POLYCARBONATE - UL94-V0 AND TESED TO PASS 5VA PER UL746C
- FOLLOW ENCLOSED INSTRUCTION FOR UL COMPLIANCE.: BOXES UL LISTED NEMA TYPE 1, 2, 3, 3R, 4, 4X, 5, 6, 6P 12, 13. DESIGNED MEETS IP65, IP66, IP67, IP68 REQUIREMENTS. UV RESISTANT FOR OUT DOOR USE.
- OPERATING TEMPERATURE IS -35 TO 110C.
- PRE INSTALLED SILICONE GASKET IN COVER
- BOX COMES WITH 4 UNINSTALLED MOUNTING BRACKETS AND HARDWARE (DPX-100)
- OPTIONAL ACCESSORIES:
  - HINGE AND PANEL SUPPENSION KIT (DPX-444KIT)
  - 6" FLANGE KIT (2 FLANGES + 4 SCREWS) (DPX-624KIT)
  - FLOATING INTERNAL MOUNTING PANEL (DPX-287074)
  - HINGED INTERNAL MOUNTING PANEL (DPX-287072)
  - COVER MOUNTING PANEL (DPX-287073)
  - BASE INTERNAL MOUNTING PANEL (DPX-287071)
- DIMENSIONS ARE INCH

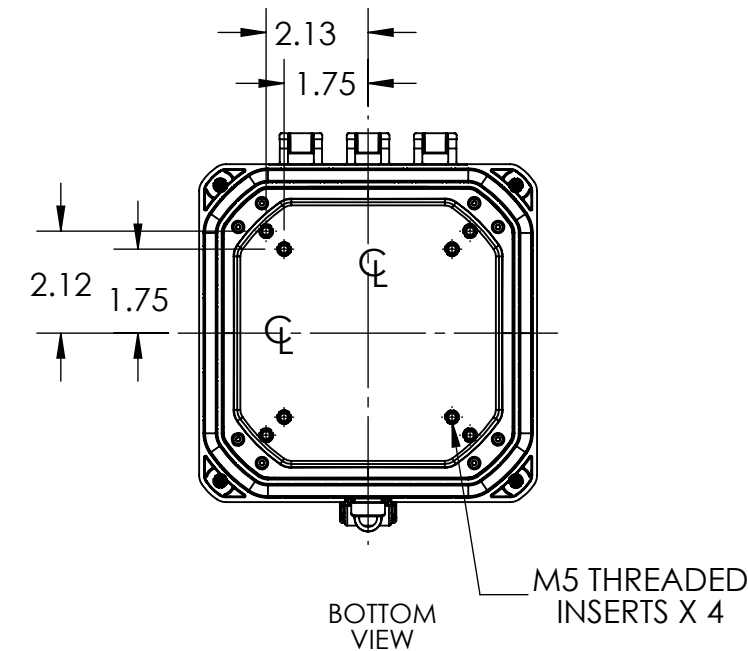
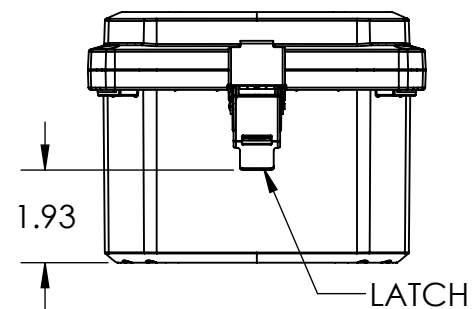
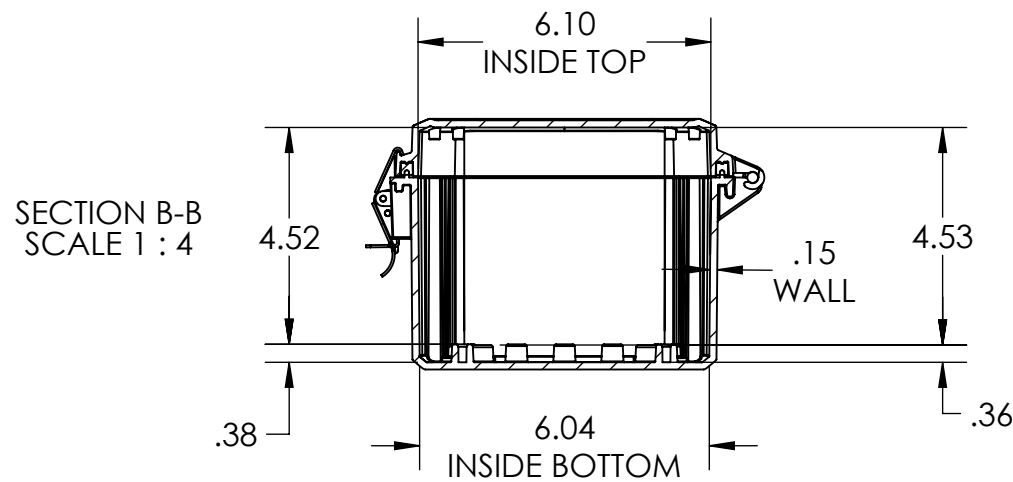
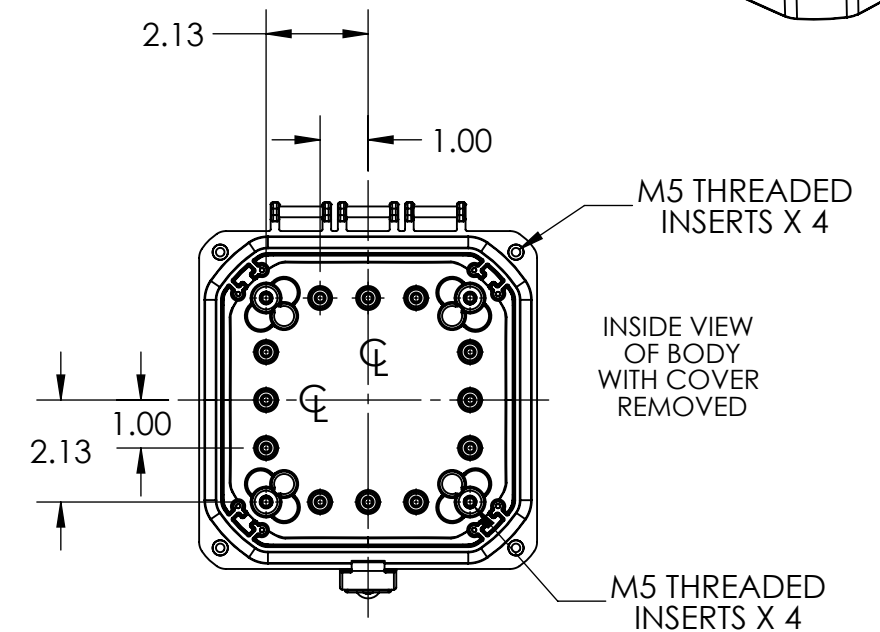
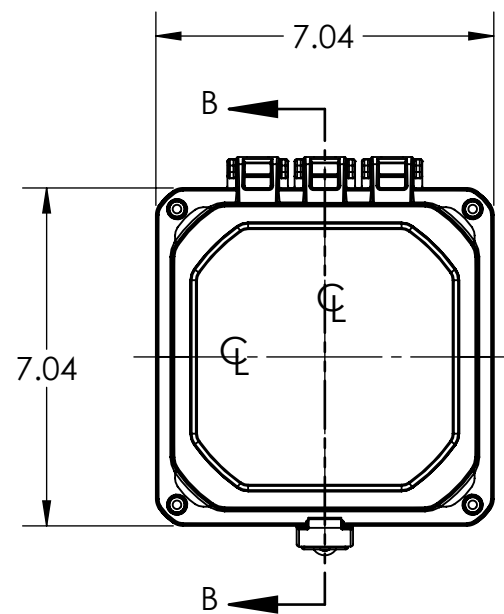
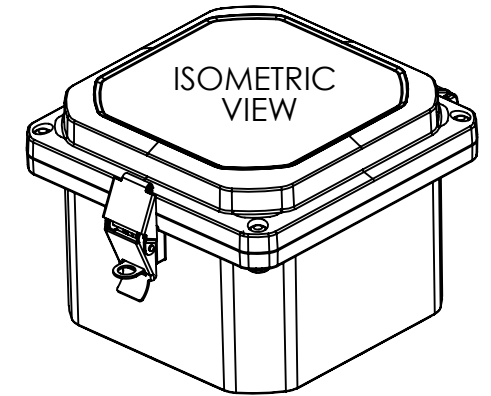
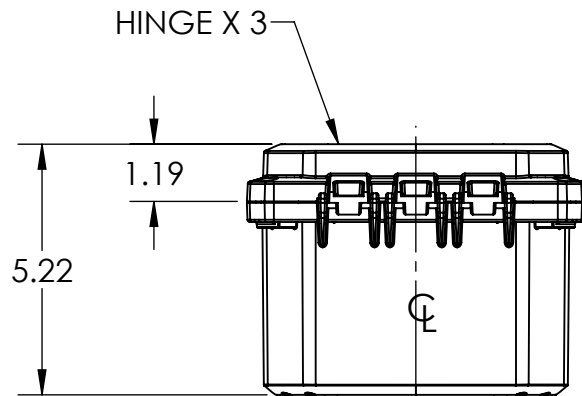

**DRAWING FOR REFERENCE**  
 WE RESERVE THE RIGHT TO MAKE CHANGES TO OUR STANDARD PRODUCTS. PLEASE CONSULT WITH BUD INDUSTRIES PRIOR TO USING THIS DRAWING FOR DESIGN PURPOSE.